

# The importance of the zero moment of truth in the "Z" generation

---

**Režić, Monika; Blažević Bognar, Zrinka; Sesvečan, Ema**

*Source / Izvornik:* **Economic and Social Development, 2024, 141 - 150**

**Conference paper / Rad u zborniku**

*Publication status / Verzija rada:* **Published version / Objavljena verzija rada (izdavačev PDF)**

*Permanent link / Trajna poveznica:* <https://um.nsk.hr/um:nbn:hr:165:853915>

*Rights / Prava:* [In copyright](#)/[Zaštićeno autorskim pravom.](#)

*Download date / Datum preuzimanja:* **2025-02-23**

*Repository / Repozitorij:*



[Virovitica University of Applied Sciences Repository - Virovitica University of Applied Sciences Academic Repository](#)



# THE IMPORTANCE OF THE ZERO MOMENT OF TRUTH IN THE "Z" GENERATION

---

**Režić, Monika; Blažević Bognar, Zrinka; Sesvečan, Ema.**

*Source / Izvornik:* **Economic and Social Development, 2024, 141 - 150**

**Conference paper / Rad u zborniku**

*Publication status / Verzija rada:* **Published version / Objavljena verzija rada (izdavačev PDF)**

*Permanent link / Trajna poveznica:* <https://um.nsk.hr/um:nbn:hr:165:457706>

*Rights / Prava:* [In copyright](#)/[Zaštićeno autorskim pravom.](#)

*Download date / Datum preuzimanja:* **2025-02-07**

*Repository / Repozitorij:*



[Virovitica University of Applied Sciences Repository -  
Virovitica University of Applied Sciences Academic  
Repository](#)



**Varazdin Development and Entrepreneurship Agency and University North**  
in cooperation with  
**Fluminense Federal University**  
**Faculty of Management University of Warsaw**  
**Faculty of Law, Economics and Social Sciences Sale - Mohammed V University in Rabat**  
**ENCGT - Ecole Nationale de Commerce et de Gestion de Tanger - Abdelmalek Essaadi University**  
**Medimurje University of Applied Sciences in Cakovec**  
**GOVCOPP - University of Aveiro**



# **Economic and Social Development**

115<sup>th</sup> International Scientific Conference on Economic and Social Development

## **Book of Proceedings**

Editors:

**Marcelo Meirinho, David Resende, Humberto Ribeiro**

ISSN 1849-7535



Rio de Janeiro, 26-27 September, 2024

**Varazdin Development and Entrepreneurship Agency and University North**  
in cooperation with  
**Fluminense Federal University**  
**Faculty of Management University of Warsaw**  
**Faculty of Law, Economics and Social Sciences Sale - Mohammed V University in Rabat**  
**ENCGT - Ecole Nationale de Commerce et de Gestion de Tanger - Abdelmalek Essaadi University**  
**Medimurje University of Applied Sciences in Cakovec**  
**GOVCOPP - University of Aveiro**

Editors:

**Marcelo Meirinho, Fluminense Federal University, Brasil**  
**David Resende, University of Aveiro, Portugal**  
**Humberto Ribeiro, University of Aveiro, Portugal**

## **Economic and Social Development**

115<sup>th</sup> International Scientific Conference on Economic and Social Development

### **Book of Proceedings**



Rio de Janeiro, 26-27 September, 2024

**Scientific Committee / Programski Odbor** ■ Marcelo J. Meirino (President), Fluminense Federal University, Brasil; Osvaldo L. G. Quelhas (Vice-President), Fluminense Federal University, Brasil; Sergio L. B. Franca, Fluminense Federal University, Brasil; Gilson B. A. Lima, Fluminense Federal University, Brasil; Julio Vieira Neto, Fluminense Federal University, Brasil; Luis Perez Zotes, Fluminense Federal University, Brasil; Amelia Cristina Ferreira da Silva, Polytechnic of Porto, Portugal; Marco Andre da Silva Costa, University of Aveiro, Portugal; Marlene Paula Castro Amorim, University of Aveiro, Portugal; Raquel Filipa do Amaral Chambre de Meneses Soares Bastos Moutinho, University of Porto, Portugal; David Nunes Resende, University of Aveiro, Portugal; Carlos Alberto da Silva Menezes, University of Minho, Portugal; Mara Teresa da Silva Madaleno, University of Aveiro, Portugal; Maria Raquel Lucas, University of Evora, Portugal; Marta Alexandra da Costa Ferreira Dias, University of Aveiro, Portugal; Eduardo Manuel de Almeida Leite, University of Madeira, Portugal; Aurea Sandra Toledo de Sousa, University of the Azores, Portugal; Elisabeth de Jesus Oliveira Brito, University of Aveiro, Portugal; Marcelo Jasmim Meirino, Fluminense Federal University, Brasil; Stella Regina Reis da Costa, Fluminense Federal University, Brasil; Gentjan Cera, Agricultural University of Tirana, Albania; Adelina Baptista, University of Aveiro, Portugal; Sannur Aliyev, Azerbaijan State University of Economics, Azerbaijan; Ayuba A. Aminu, University of Maiduguri, Nigeria; Anona Armstrong, Victoria University, Australia; Gouri Sankar Bandyopadhyay, The University of Burdwan, Rajbati Bardhaman, India; Haimanti Banerji, Indian Institute of Technology, Kharagpur, India; Victor Beker, University of Buenos Aires, Argentina; Asmae Benthani, Mohammed V University, Morocco; Alla Bobyleva, The Lomonosov Moscow State University, Russia; Leonid K. Bobrov, State University of Economics and Management, Novosibirsk, Russia; Rado Bohinc, University of Ljubljana, Slovenia; Adnan Celik, Selcuk University, Konya, Turkey; Angelo Maia Cister, Federal University of Rio de Janeiro, Brasil; Mirela Cristea, University of Craiova, Romania; Taoufik Daghrri, Mohammed V University, Morocco; Oguz Demir, Istanbul Commerce University, Turkey; T.S. Devaraja, University of Mysore, India; Onur Dogan, Dokuz Eylul University, Turkey; Darko Dukic, University of Osijek, Croatia; Gordana Dukic, University of Osijek, Croatia; Alba Dumi, Vloora University, Vlore, Albania; Galina Pavlovna Gagarskaya, Samara State University, Russia; Mirjana Gligoric, Faculty of Economics - Belgrade University, Serbia; Mustafa Goktug Kaya, KTO Karatay University, Turkey; Maria Jose Angelico Goncalves, Porto Accounting and Business School - P.Porto, Portugal; Mehmet Emre Gorgulu, Afyon Kocatepe University, Turkey; Klodiana Gorica, University of Tirana, Albania; Aleksandra Grobelna, Gdynia Maritime University, Poland; Liudmila Guzikova, Peter the Great Saint-Petersburg Polytechnic University, Russia; Anica Hunjet, University North, Koprivnica, Croatia; Khalid Hammes, Mohammed V University, Morocco; Oxana Ivanova, Ulyanovsk State University, Ulyanovsk, Russia; Irena Jankovic, Faculty of Economics, Belgrade University, Serbia; Myrl Jones, Radford University, USA; Hacer Simay Karaalp, Pamukkale University, Turkey; Dafna Kariv, The College of Management Academic Studies, Rishon Le Zion, Israel; Hilal Yildirim Keser, Uludag University, Bursa, Turkey; Sophia Khalimova, Institute of Economics and Industrial Engineering of Siberian Branch of Russian Academy of Science, Novosibirsk, Russia; Marina Klacmer Calopa, University of Zagreb, Croatia; Igor Klopotan, Medjimursko Veleuciliste u Cakovcu, Croatia; Vladimir Kovsca, University of Zagreb, Croatia; Goran Kozina, University North, Koprivnica, Croatia; Dzenan Kulovic, University of Zenica, Bosnia and Herzegovina; Petar Kurecic, University North, Croatia; Robert Lewis, Les Roches Gruyere University of Applied Sciences, Bulle, Switzerland; Ladislav Lukas, Univ. of West Bohemia, Faculty of Economics, Czech Republic; Mustapha Machrafi, Mohammed V University, Morocco; Ahmed Maghni, The National School of Business and Management of Tangier, Morocco; Joao Jose Lourenco Marques, University of Aveiro, Portugal; Pascal Marty, University of La Rochelle, France; Vaidotas Matutis, Vilnius University, Lithuania; Daniel Francois Meyer, North West University, South Africa; Marin Milkovic, University North, Koprivnica, Croatia; Abdelhamid Nechad, ESCA - Ecole de Management, Morocco; Gratiela Georgiana Noja, West University of Timisoara, Romania; Zsuzsanna Novak, Corvinus University of Budapest, Hungary; Tomasz Ochowski, University of Warsaw, Poland; Barbara Herceg Paksic, University of Osijek, Croatia; Vera Palea, Universita degli Studi di Torino, Italy; Dusko Pavlovic, Libertas International University, Zagreb, Croatia; Igor Pihir, University of Zagreb, Croatia; Dmitri Pletnev, Chelyabinsk State University, Russian Federation; Miroslaw Przygoda, University of Warsaw, Poland; Karlis Purnalis, University of Latvia, Latvia; Nicholas Recker, Metropolitan State University of Denver, USA; Kerry Redican, Virginia Tech, Blacksburg, USA; Douglas Rhein, Mahidol University International College, Thailand; Humberto Nuno Rito Ribeiro, Polytechnic of Porto, Portugal; Robert Rybnicek, University of Graz, Austria; Elzbieta Szymanska, Bialystok University of Technology, Poland; Katarzyna Szymanska, The State Higher School of Vocational Education in Ciechanow, Poland; Iliaria Tutore, University of Naples Parthenope, Italy; Sandra Raquel Pinto Alves, Polytechnic of Leiria, Portugal; Joanna Stawska, University of Lodz, Poland; Ilko Vrankic, University of Zagreb, Croatia; Stanislaw Walukiewicz, Bialystok University of Technology, Poland; Thomas Will, Agnes Scott College, USA; Li Yongqiang, Victoria University, Australia; Peter Zabielskis, University of Macau, China; Silvija Zeman, Medjimursko Veleuciliste u Cakovcu, Croatia; Tao Zeng, Wilfrid Laurier University, Waterloo, Canada; Snezana Zivkovic, University of Nis, Serbia.

**Review Committee / Recenzentski Odbor** ■ Sergio L. B. Franca (President); Marcelo J. Meirino; Osvaldo L. G. Quelhas; Marta Alexandra da Costa Ferreira Dias; Mariza Almeida; Jose Manuel Teixeira Pereira; Joao Jose Lourenco Marques; Mara Teresa da Silva Madaleno; David Nunes Resende; Marco Andre da Silva Costa; Marlene Paula Castro Amorim; Amelia Cristina Ferreira da Silva; Raquel Filipa do Amaral Chambre de Meneses Soares Bastos Moutinho; Maria Alexandra Soares Fontes; Eduardo Manuel de Almeida Leite; Magda Sofia Valerio Monteiro; Adelina Baptista; Augusto Raupp; Branca Santos e Silva; Stella Regina Reis da Costa; Cristina Guardado; Marina Klacmer Calopa; Ana Aleksic; Sandra Raquel Pinto Alves; Ayuba Aminu; Mihovil Andjeljinovic; Josip Arneric; Lidija Bagaric; Tomislav Bakovic; Sanja Blazevic; Leonid Bobrov; Ruzica Brebic; Anita Ceh Casni; Iryna Chernysh; Mirela Cristea; Oguz Demir; Stjepan Dvorski; Robert Fabac; Ivica Filipovic; Sinisa Franjic; Fran Galetic; Mirjana Gligoric; Tomislav Globan; Anita Goltnik Urnaut; Tomislav Herceg; Irena Jankovic; Emina Jerkovic; Dafna Kariv; Oliver Kesar; Hilal Yildirim Keser; Martina Dragija Kostic; Tatjana Kovac; Vladimir Kovsca; Angelo Maia Cister; Katarina Marosevic; Vaidotas Matutis; Marjana Merkak Skok; Daniel Francois Meyer; Natanya Meyer; Josip Mikulic; Ivana Miklosevic; Ljubica Milanovic Glavan; Guenter Mueller; Ivana Nacinovic Braje; Zlatko Nedelko; Gratiela Georgiana Noja; Zsuzsanna Novak; Alka Obadic; Claudia Ogrea; Igor Pihir; Najla Podrug; Vojko Potocan; Dinko Primorac; Zeljka Primorac; Sanda Renko; Humberto Nuno Rito Ribeiro; Vlasta Roska; Souhaila Said; Armando Javier Sanchez Diaz; Tomislav Sekur; Lorena Skufflic; Mirko Smoljic; Petar Soric; Mario Spremic; Matjaz Stor; Tomasz Studzieniecki; Lejla Tijanac; Daniel Tomic; Boris Tusek; Rebeka Daniela Vlahov; Ilko Vrankic; Thomas Will; Zoran Wittine; Tao Zeng; Grzegorz Zimon; Snezana Zivkovic; Berislav Zmuk.

**Organizing Committee / Organizacijski Odbor** ■ Marcelo J. Meirino (President); Osvaldo L. G. Quelhas; Sergio L. B. Franca; Humberto Nuno Rito Ribeiro; David Nunes; Elisabeth de Jesus Oliveira Brito; Sandra Raquel Pinto Alves; Amelia Cristina Ferreira da Silva; Marlene Paula Castro Amorim; Stella Regina Reis da Costa; Domagoj Cingula; Djani Bunja; Marina Klacmer Calopa; Spomenko Kesina; Erlino Koscak; Ivana Miklosevic; Tomasz Ochowski; Miroslaw Przygoda; Michael Stefulj; Tomasz Studzieniecki; Rebeka Danijela Vlahov; Sime Vucetic.

**Publishing Editor** ■ Spomenko Kesina, Domagoj Cingula

**Publisher** ■ **Design** ■ **Print** ■ Varzadin Development and Entrepreneurship Agency, Varzadin, Croatia / University North, Koprivnica, Croatia / Fluminense Federal University, Rio de Janeiro, Brasil / GOVCOPP - University of Aveiro, Aveiro, Portugal / Faculty of Management University of Warsaw, Warsaw, Poland / Faculty of Law, Economics and Social Sciences Sale - Mohammed V University in Rabat, Morocco / ENCGT - Ecole Nationale de Commerce et de Gestion de Tanger - Abdelmalek Essaadi University, Tangier, Morocco / Medimurje University of Applied Sciences in Cakovec, Cakovec, Croatia

**Printing** ■ Online Edition

**ISSN 1849-7535**

The Book is open access and double-blind peer reviewed.

Our past Books are indexed and abstracted by ProQuest, EconBIZ, CPCI (Web of Science) and EconLit databases and available for download in a PDF format from the Economic and Social Development Conference website: <http://www.esd-conference.com>

© 2024 Varzadin Development and Entrepreneurship Agency, Varzadin, Croatia; University North, Koprivnica, Croatia; Fluminense Federal University, Rio de Janeiro, Brasil; GOVCOPP - University of Aveiro, Aveiro, Portugal; Faculty of Management University of Warsaw, Warsaw, Poland; Faculty of Law, Economics and Social Sciences Sale - Mohammed V University in Rabat, Morocco; ENCGT - Ecole Nationale de Commerce et de Gestion de Tanger - Abdelmalek Essaadi University, Tangier, Morocco; Medimurje University of Applied Sciences in Cakovec, Cakovec, Croatia. All rights reserved. Authors are responsible for the linguistic and technical accuracy of their contributions. Authors keep their copyrights for further publishing.

## **CONTENTS**

<b>DYNAMIC MODELLING FOR DECISION SUPPORT IN CHANGE MANAGEMENT BY ARTIFICIAL INTELLIGENCE.....</b>	<b>1</b>
Marcelo dos Santos Povoas, Jessica Freire Moreira, Gilson Brito Alves Lima, Nissia Carvalho Rosa Bergiante	
<b>ECONOMIC AND SOCIAL CONSEQUENCES OF FICTITIOUS TRADES IN THE SLOVAK REPUBLIC.....</b>	<b>12</b>
Peter Sika	
<b>THE INTERSECTION OF ARTIFICIAL INTELLIGENCE AND GREEN AND SUSTAINABLE INSURANCE: A PRISMA COMPLIANT ANALYSIS AND LITERATURE REVIEW .....</b>	<b>20</b>
Katerina Fotova Cikovic, Marin Milkovic, Martina Hajdek	
<b>SUSTAINABILITY PERFORMANCE ASSESSMENT OF ACCOMMODATION FACILITIES IN ARMAÇÃO DOS BÚZIOS, RJ (BRAZIL): A CASE STUDY IN LIGHT OF THE ESG CRITERIA LISTED IN ABNT PR 2030:2022.....</b>	<b>29</b>
Jaqueline Kropf Esteves de Matos, Marcelo Miguel da Cruz, Sergio Ricardo da Silveira Barros, Luis Alberto Duncan Rangel, Gilson Brito Alves Lima	
<b>HUMAN FACTORS AND NEW VIEWS OF SAFETY APPLIED TO MANAGEMENT SYSTEMS: A SYSTEMATIC LITERATURE REVIEW .....</b>	<b>47</b>
Jose Leonidas Bier Brasileiro, Julio Cesar de Faria Alvim Wasserman, Gilson Brito Alves Lima	
<b>APPLICATIONS OF MACHINE LEARNING AND ARTIFICIAL INTELLIGENCE IN THE OIL AND GAS INDUSTRY: A STUDY OF KEYWORDS AND RESEARCH RESULTS .....</b>	<b>57</b>
Marcelo dos Santos Povoas, Severino Virginio Martins Neto, Jessica Freire Moreira, Gilson Brito Alves Lima	
<b>HIERARCHIZATION MODEL APPLIED IN OIL AND GAS COMPANIES USING THE TRIPLE BOTTOM LINE.....</b>	<b>66</b>
Juliana Damaris Candido, Ruben Huamanchumo Gutierrez, Gilson Brito Alves Lima	
<b>ANALYSIS OF OCCUPATIONAL HEALTH AND SAFETY TRENDS IN BRAZILIAN ECONOMIC SECTORS: .....</b>	<b>75</b>
Dayanni de Brito da Silva, Renan Silva Santos, Maria de Lurdes Costa Domingos	
<b>CYBER INSURANCE IN BRAZIL: ANALYSIS OF BENEFITS AND CHALLENGES .....</b>	<b>85</b>
Karla Siqueira de Oliveira, Carolina Cardoso Novo, Mirian Picinini Mexas, Lidia Angulo Meza	
<b>LITERATURE REVIEW: SUSTAINABLE HUMAN RESOURCE MANAGEMENT.</b>	<b>95</b>
Andrea de Sousa Figueira, Stella Regina Reis da Costa, Izabela Simon Rampasso, David Nunes Resende	

**CRISIS COMMUNICATION IN ADVERTISING AGENCIES: STRATEGIES AND PRINCIPLES OF ITS EFFECTIVE MANAGEMENT ON SOCIAL MEDIA ..... 104**

Veronika Stevcac Szaboova

**A PROPOSED METHODOLOGY FOR KNOWLEDGE MANAGEMENT IN TECHNOLOGY-BASED STARTUP..... 116**

Marco Antonio Damiao de Mello, Stella Regina Reis da Costa, David Nunes Resende

**THE INFLUENCE OF SOCIAL MEDIA PLATFORMS ON ONLINE SHOPPING BEHAVIOUR AND CONSUMER DECISION-MAKING PROCESS..... 124**

Marina Gregoric, Sebastian Nowik, Philipp Schorn

**THE IMPORTANCE OF THE ZERO MOMENT OF TRUTH IN THE "Z" GENERATION ..... 141**

Monika Rezic, Zrinka Blazevic Bognar, Ema Sesvecan

**DECODING ORGANIZATIONAL DYNAMICS: THE INTERSECTION OF LISTENING-BASED EMOTIONAL INTELLIGENCE AND SOCIAL AWARENESS IN DECISION-MAKING..... 151**

Morena Paulisic, Katarina Kostelic, Maja Doja

**THE CHANGING ASPECTS OF CROATIAN COMPANIES' EFFICIENCY BEFORE AND AFTER COVID-19 .....184**

Danijel Petrovic

## **DYNAMIC MODELLING FOR DECISION SUPPORT IN CHANGE MANAGEMENT BY ARTIFICIAL INTELLIGENCE**

**Marcelo dos Santos Povoas**

*Universidade Federal Fluminense, R. Passo da Pátria, 152-470 - São Domingos,  
Niterói - RJ, 24210-240, Brazil  
marcelopovoas@id.uff.br*

**Jessica Freire Moreira**

*Universidade Federal Fluminense. R. Passo da Pátria, 152-470 - São Domingos,  
Niterói - RJ, 24210-240, Brazil  
jessicafreiremoreira@id.uff.br*

**Gilson Brito Alves Lima**

*Universidade Federal Fluminense, R. Passo da Pátria, 152-470 - São Domingos,  
Niterói - RJ, 24210-240, Brazil  
glima@id.uff.br*

**Nissia Carvalho Rosa Bergiante**

*Universidade Federal Fluminense, R. Passo da Pátria, 152-470 - São Domingos,  
Niterói - RJ, 24210-240, Brazil  
nissiabergiante@id.uff.br*

### **ABSTRACT**

*This study proposes an original approach to be used in the strategic decision management process, taking into account the identification and prioritization of potential risks of failure in Management of Change (MOC) in an industrial environment. The modelling will include, in an original way, the search for the classification and prediction of probabilistic events, by artificial intelligence (AI), so that the analysis can be done in a more automated way, generating reports that can help in more adequate and realistic results to the model of information management. Machine learning can help in decision-making to manage changes through algorithms that generate reports with data from previously faced problems. Possible results and contributions are a database with information already collected in the studied company, as well as a functional algorithm for solving the presented problem and a functionality test of this algorithm.*

**Keywords:** *AI, Machine Learning, MOC*

### **1. INTRODUCTION**

Change-oriented leadership has a positive and significant direct effect on planned change and a positive and significant but indirect effect on emergent change and it was found that hierarchical culture had a positive and significant impact directly on the management of planned changes and emerging in organizations (WAINWRIGHT, *et al.*, 2019). Along with information related challenges, the range and types of information representations have changed significantly (DUAN *et al.*, 2019). The popularity of AI has become a challenging problem in the world and therefore brought ever-increasing impact with both benefits and negatives in a wide range of industries that have brought great difficulties and challenges to traditional data understanding and analysis (CHEN *et al.*, 2019).



### **1.1. Management of Change (MOC)**

According to Mathar and Gaur (2020), change management is still the main organizational instrument for successfully changing processes, people, and systems, leveraging tools, technology and resources without compromising the organization. To Hammami *et al.* (2020), learning efficient models in dynamic environments requires considering the continuously changing nature of phenomena generating the data streams. Current benchmarks of quality, conformance, productivity, and innovation in industrial manufacturing have set a very high bar for machine learning algorithms (ESCOBAR *et al.*, 2021). Due to the ever-changing landscapes, it is imperative for MoC managers to prioritize the integration of innovative tools like AI into their operations (LEMOS *et al.*, 2022). AI is a potentially transformative force that is likely to change the role of management and organizational practices, having revolutionary impacts on organizational decision making and redefining management models (PHAN *et al.*, 2022). AI is changing the form of the interactions with information and processing (DENNEHY *et al.*, 2022). These changes portend that necessity the attention to the ways in which information is received, conceived, interpreted, and acted upon (SAMUEL *et al.*, 2022). This kind of new information environments have created significant ambiguity about the alignment of information representations with decision needs to optimize human performance (KNOW *et al.*, 2022). The development of this model has an originality, leaders are decision-makers in the organization (WIJAYATI *et al.*, 2022). With the involvement of senior management, initiatives such as communicating the benefits of implementing AI should become a reality in the company (LEMOS, 2022). For Vishwakarma and Singh (2023), this methodology is being used to solve complex problems in the industry because it provides several benefits such as providing visibility in the processes, reducing time, improving accuracy, saving time, and helping in the decision-making process. The growing interest towards operation flexibility has pushed companies to introduce novel solutions on the shop floor, leading to installing AI for advanced human-machine collaboration (POLENGHI *et al.*, 2023). With this, the research question were defined: RQ1: How can machine learning and AI help in a risk reduction process in a MOC process?

## **2. METHODOLOGICAL APPROACH**

The steps proposed for carrying out the research are presented below: Analysis and review of available works on artificial intelligence, machine learning, hierarchical analysis of processes and change management; Analysis and creation of a flowchart of the activities developed in the company to be studied; Survey, based on the literature and with data from the company studied, of the most important points that will appear in the questionnaire to be answered by relevant people who work or study on the proposed theme; Elaboration of questionnaires using the software "Google Forms" sent by the socio-professional network LinkedIn. The most significant factors for the process will be identified and used in statements to be evaluated, according to the degree of importance, by people who work in the area. 100 questionnaires were selected and answered by different professionals. This work has the main objective to describe how machine learning can be a tool to reduce the time of issuing and preparing reports using statistics and help leaders to adapt to a climate of changes in order to avoid scratches. From smart grids to risk management, high-impact issues will be identified where existing gaps can be filled by AI, in collaboration with other areas. As developments, the following secondary objectives will be developed: a) to develop an algorithm for the application of digital technologies in the MOC; b) develop methodology for the use of digital technologies in the MOC; c) analyse the severity of the critical factors and whether the program's response really makes sense for the question presented. With the most critical elements defined, an algorithm using *Matlab* software will be created to define possible improvement solutions through a database, where historical implementation of previous solutions and relevant work on areas

related to the company and operations will be stored. performed on it. With the feeding of problems and solutions in the database and AI, together, it will be possible that better analyses can be done and in a more automated way, generating reports that can help in decision making. Regarding the programming, for the purpose of testing the program, the bank and the software will be tested for the management of changes in an aircraft engine maintenance company using data referring to areas of high criticality of operations.

### 3. RESULTS

As a result of this study, the main critical factors were identified. 100 questionnaires were selected and answered by different professionals. The diagrams show the impact of the insertion of the MOC in the productive processes. These scores are presented in Table 6, which shows that the most critical factors that affect the system are: Lack of risk assessment in the MOC process, Lack of Stakeholder involvement, and Lack of knowledge of the employees involved in the MOC process. Scores are color-coded according to the criteria defined in Table 1.

Classification	Risks	Impact
People	Lack of stakeholder involvement in the process	0,441
Managerial	As a consequence, company reorganization is not considered in the MOC process	0,441
General	Lack of risk assessment in the MOC process	0,441
Managerial	Lack of standard procedures on how to conduct the MOC system	0,441
General	Change actions performed when post-change checks were performed.	0,441
People	Lack of knowledge of employees involved in the MOC process	0,441
General	Lack of definition of authorization steps (gates)	0,441
Managerial	Lack of planning in the activities of the MOC process	0,441
People	Lack of training of employees involved in the MOC	0,441
General	Major changes in the company's system are not considered in the MOC process	0,441
People	Lack of good teamwork environment	0,441
General	Changes in key positions are not considered in the MOC process	0,441
Managerial	New contract / Introduction of new requirements with customers, suppliers, employees not covered in the MOC process	0,441

*Table 1: Impact Table  
Source: The authors (2021).*

Where the impact points were as shown in the table created by Baldini, *et al.* (2021), the factors are arranged as shown in Table 1, which can be seen in Table 2.

*Table following on the next page*

Tipo	MAX	MAX	MAX	MIN	MAX	MAX	MIN	MIN	MAX	MAX	MIN	MIN	MIN
	C1	C2	C3	C4	C5	C6	C7	C8	C9	C10	C11	C12	C13
A1	4000	11	30	25	1	0	125	250	120	4	145	120	30
A2	9330	26	25	25	2	1	145	110	250	650	620	80	5
A3	10660	30	35	120	2	1	125	140	3	100	140	140	10

	C1	C2	C3	C4	C5	C6	C7	C8	C9	C10	C11	C12	C13
C1	1	1	1	0,333333	5	1	0,333333	0,333333	0,25	0,333333	0,111111	7	0,25
C2	1	1	1	1	5	1	9	1	3	0,25	9	1	0,33333
C3	1	1	1	0,333333	5	1	0,333333	1	0,25	0,333333	7	0,333333	0,25
C4	3	3	3	1	3	1	0,333333	0,333333	9	1	3	9	0,111111
C5	0,2	0,2	0,2	0,333333	1	0,2	0,2	0,25	0,111111	0,111111	1	0,333333	0,142857
C6	1	1	1	1	5	1	0,333333	9	0,333333	0,333333	0,333333	1	0,333333
C7	3	3	3	3	5	3	1	1	1	1	0,111111	3	1
C8	3	3	3	3	5	3	1	1	1	0,25	0,25	0,333333	1
C9	4	0,333333	4	0,111111	9,000009	3	1	1	1	3	5	0,25	9
C10	3	4	3	1	9,000009	3,000003	1	4	0,333333	1		0,111111	3
C11	9,000009	0,111111	0,142857	0,333333	1	3	9,000009	4	0,2	0	1	7	5
C12	0,142857	1	3	0,111111	3	1	0,333333	3,000003	4	9,000009	0,142857	1	7
C13	4	3,00003	4	9,000009	7	3	1	1	0,111111	0,333333	0,2	0,142857	1

	C1	C2	C3	C4	C5	C6	C7	C8	C9	C10	C11	C12	C13	Soma	Normaliz ação		
C1	0,030	0,046	0,037	0,016	0,079	0,041	0,013	0,012	0,012	0,020	0,004	0,229	0,009	0,550	0,042		
C2	0,030	0,046	0,037	0,049	0,079	0,041	0,362	0,037	0,146	0,015	0,332	0,033	0,012	1,218	0,094		
C3	0,030	0,046	0,037	0,016	0,079	0,041	0,013	0,037	0,012	0,020	0,258	0,011	0,009	0,610	0,047		
C4	0,090	0,139	0,110	0,049	0,048	0,041	0,013	0,012	0,437	0,059	0,111	0,295	0,004	1,407	0,108		
C5	0,006	0,009	0,007	0,016	0,016	0,008	0,008	0,009	0,005	0,007	0,037	0,011	0,005	0,145	0,011		
C6	0,030	0,046	0,037	0,049	0,079	0,041	0,013	0,334	0,016	0,020	0,012	0,033	0,012	0,723	0,056		
C7	0,090	0,139	0,110	0,146	0,079	0,124	0,040	0,037	0,049	0,059	0,004	0,098	0,035	1,010	0,078		
C8	0,090	0,139	0,110	0,146	0,079	0,124	0,040	0,037	0,049	0,015	0,009	0,011	0,035	0,884	0,068		
C9	0,120	0,015	0,146	0,005	0,143	0,124	0,040	0,037	0,049	0,177	0,184	0,008	0,317	1,366	0,105		
C10	0,090	0,185	0,110	0,049	0,143	0,124	0,040	0,149	0,016	0,059	0,000	0,004	0,106	1,073	0,083		
C11	0,270	0,005	0,005	0,016	0,016	0,124	0,362	0,149	0,010	0,000	0,037	0,229	0,176	1,399	0,108		
C12	0,004	0,046	0,110	0,005	0,048	0,041	0,013	0,111	0,194	0,531	0,005	0,033	0,246	1,389	0,107		
C13	0,120	0,139	0,146	0,438	0,111	0,124	0,040	0,037	0,005	0,020	0,007	0,005	0,035	1,227	0,094		
A1	0,167	0,164	0,333	0,453	0,200	0,000	0,349	0,198	0,322	0,005	0,441	0,298	0,100	AHP-G	RANK	AHP	RANK
A2	0,389	0,388	0,278	0,453	0,400	0,500	0,301	0,449	0,670	0,862	0,103	0,447	0,600	0,191	3,000	0,253	3,000
A3	0,444	0,448	0,389	0,094	0,400	0,500	0,349	0,353	0,008	0,133	0,456	0,255	0,300	0,535	1,000	0,458	1,000
														0,274	2,000	0,289	2,000
Média	0,333	0,333	0,333	0,333	0,333	0,333	0,333	0,333	0,333	0,333	0,333	0,333	0,333				
Desvio Padrão	0,147	0,150	0,056	0,207	0,115	0,289	0,028	0,127	0,331	0,462	0,200	0,101	0,252				
Fator Gaussiano	0,441	0,449	0,167	0,621	0,346	0,866	0,083	0,381	0,994	1,387	0,599	0,302	0,755				
Fator G. Norma.	0,060	0,061	0,023	0,084	0,047	0,117	0,011	0,052	0,134	0,188	0,081	0,041	0,102				

Table 2: Impact Table  
 Source: Baldini, et al. (2021) and the authors (2021).

The answer can be used in an algorithm. Through machine learning, an algorithm was created capable of presenting the expected results in the management of change in a company through experiences previously carried out and saved in a database. For example, if a certain change has already been made and it was successful, every time that change happens again, that factor will appear on the screen. Code comments are shown in red.

```

% This Program uses data for training and testing a network
% MLP neural
% Clear the screen and delete variables that are in memory
clc;
clear all;
warning off;
k = '0';
fim = 0;
home;
load matzdados;
load Target; %charge the targets of the method
nlintreina = size(target_treina,1); % number of training matrix lines
nlinteste = size(target_teste,1); % number of test matrix lines
% Transpose the test code and target training matrices
dados_treina = dados_treina';
dados_teste = dados_teste';
    target_treina = target_treina';
    target_teste = target_teste';
    % number of network inputs and outputs
    entradas = size(dados_treina,1);
    saidas = size(target_treina,1);
    % neurons in the hidden layer
    neuro = floor((entradas + saidas)/2);
    % Change case data
    Persona = input('Coloque os dados da mudança: ');
    for k = 1:10
    % Creates a Feedforward MLP network
    net = newff(minmax(dados_treina),[neurosaidas],{'logsig','logsig','traingdx'});
    info= ['Rodada nr. ',int2str(k)];
    display(info);

    % Network training parameters
    net.trainParam.epochs = 2100;
    % Number of epochs
    net.trainParam.goal = 0.001; % Minimum error
    net.trainParam.lr = 0.4; % Learning rate
    net.trainParam.mc = 0.5; % Momentum
    % Train the network
    [net,tr] = train(net,dados_treina,target_treina);
    % Tests the network
    y = sim(net,dados_teste);
    % Discretize the network output according to the "winner takes all" strategy
    for j = 1:nlinteste
    maior = max(y(1:6,j));
    for i = 1:6
    if maior == y(i,j)
    yd(i,j) = 1;
    else yd(i,j) = 0;
    end
    end
    % Calculate the number of correct, incorrect and rejected classifications
    result = target_teste - yd;
    incorretos = 0;
    corretos = 0;
    rejeicoes = 0;
    for j = 1:nlinteste
    cont1 = 0;
    cont2 = 0;
    cont3 = 0;
    for i = 1:6
    if result(i,j) == 1
    cont1 = cont1 + 1;
    elseif result(i,j) == -1
    cont2 = cont2 + 1;
    elseif result(i,j) == 0;
    cont3 = cont3 + 1;
    end

```

```

end
if cont1 == 1 & cont2 == 1
incorretos = incorretos + 1;
    elseif cont2 >= 1
rejeicoes = rejeicoes + 1;
    else
corretos = corretos + 1;
    end
end
% Calculates the percentage of
correct, incorrect classifications
and rejections
percentcorretos = (corretos *
100) / nlinteste;
percentincorretos = (incorretos
* 100) / nlinteste;
percentrejeicoes = (rejeicoes *
100) / nlinteste;
%
Calculatetheconfusionmatrix
confusao = zeros(6,6);
for j = 1:nlinteste
    cont0 = 0;
    cont1 = 0;
    cont2 = 0;
    for i = 1:6
    if result(i,j) == 0
        cont0 = cont0 + 1;
    elseif result(i,j) == 1
        cont1 = cont1 + 1;
    elseif result(i,j) == -1
        cont2 = cont2 + 1;
    end
    end
    if cont0 == 10
    lin = find(target_teste(1:6,j));
    confusao(lin,lin) =
    confusao(lin,lin) + 1;
    elseif cont1 == 1 & cont2 == 1
    col = find(result(1:6,j) == 1);
    lin = find(result(1:6,j) == -1);
    confusao(lin,col) =
    confusao(lin,col) + 1;
    end
end
end

```

This code generates a program for training and testing an MLP neural network. It loads training and test data, sets the neural network parameters, trains the network with the training data, tests the network with the test data, and evaluates the network's performance.

- 1) The code starts by importing the training and test data from a matrix previously saved in the "matzdados" file and the targets of the classification method in the "Target" file.
- 2) The following lines define the variables "nlintreina" and "nlinteste", which represent the number of lines in the training and test matrices, respectively.
- 3) Then the data matrices and training and testing targets are transposed to ensure the correct orientation of the data to the neural network.
- 4) The variables "inputs" and "outputs" are defined to represent the number of inputs and outputs of the neural network, respectively. This is calculated based on the dimensions of the training data arrays.
- 5) The variable "neuro" is calculated as the number of neurons in the hidden layer, which is approximately half of the sum of the number of inputs and outputs of the network.
- 6) The user is prompted to enter change data.
- 7) Then a loop starts, which runs 10 times. This allows you to perform several rounds of training and testing to assess the average performance of the neural network.
- 8) Inside the loop, an MLP neural network is created using the "newff" function. It receives as arguments the range of input values, the number of neurons in the output layer, the activation function of the hidden and output layers, and the training algorithm.
- 9) The network training parameters are configured, including the number of epochs, the minimum error objective, the learning rate and the moment.
- 10) The neural network is trained using the "train" function. Training data and targets are passed as arguments.

Overall, the code trains and tests an MLP neural network for classification, providing performance metrics such as the percentage of correct classifications and the confusion matrix. It can be used to evaluate the effectiveness of the neural network model. Implementing this algorithm on machines spread across the enterprise saves time and less chance of errors compared to reviewing risk analyses manually. In addition, there would be no factor of human experiences making this methodology more generic and uninfluenced by the unique perceptions of each one.

#### **4. CONCLUSION**

Through machine learning, an algorithm was created capable of presenting the expected results in the management of changes in a company through repetition rules. Observing the innumerable advantages presented by the algorithm, it is concluded that its applications tend to grow in the management area, mainly where more traditional optimization methods do not present satisfactory results. The advantages that should be highlighted are: versatility and robustness of the model. Because it is a versatile algorithm, it is easy to introduce adaptations in the program to meet the different characteristics of each process being optimized. Often, for very complex systems, this type of optimization can consume a lot of processing time. This problem can be reduced with the use of parallel computing, where parts of the program that require more time can be executed simultaneously. By associating the algorithm with already established MOC techniques for optimization and multivariate analysis, it may be possible to develop simpler mathematical models, facilitating their analysis and understanding. It is important to note that this optimization technique, like any other, does not guarantee that the best condition for an optimization has been determined. However, it has been observed that the genetic algorithm, in some cases, presents better results than other optimization techniques.

In response to the question, machine learning can help in decision-making to manage changes through algorithms that generate reports with data from previously faced problems. A future work project may include adding new information and the code may already provide the best answer.

#### LITERATURE:

1. Baldini, F.; Santos, M.; Coelho, L.; Mariani, V. AHP-GAUSSIANO em VBA (v.1) 2021.
2. Bengio, Y.; Lodi, A.; Prouvost, A. Machine learning for combinatorial optimization: A methodological tour d'horizon. *European Journal of Operational Research*, 2020.
3. Bianchi, D.; Buncher, M.; Tamoni, A. Bond Risk Premiums with Machine Learning. *The Review of Financial Studies*, Vol. 34, pp. 1046–1089, 2021.
4. Cerutti, F.; Giacomini, M.; Vallati, M. How we designed winning algorithms for abstract argumentation and which insight we attained. *Artificial Intelligence*, Vol. 276, pp. 1-40, 2019.
5. Chen, N., Liu, W., Bai, R. et al. Application of computational intelligence technologies in emergency management: a literature review. *Artificial Intelligence Review*, 52, pp. 2131–2168, 2019.
6. Dennehy, D.; Griva, A.; Poulodi, N.; Mantymaki, M.; Pappas, I. Artificial intelligence for decision-making and the future of work. *International Journal of Information Management*, 2022.
7. Duan, Y.; Edwards, J.; Dwivedi, Y. Artificial intelligence for decision making in the era of Big Data—evolution, challenges and research agenda. *International Journal of Information Management*, 2019.
8. Escobar, C.; Amcgovern, M.E.; Morales-Menendez, R. Quality 4.0: a review of big data challenges in manufacturing. *Journal of Intelligent Manufacturing*, 32, pp. 2319–2334, 2021.
9. Feng, G.; Polson, N.; Xu, J. Deep learning alpha. Working Paper, Chicago Booth, 2019.
10. Gillath, O.; Ai, T.; Branicky, M.; Keshmiri, S.; Davidson, S.; Spaulding, R. Attachment and trust in artificial intelligence. *Computers in Human Behavior*, Vol. 115, 2021.
11. Hair Jr., J.; Sarstedt, M. Data, measurement, and causal inferences in machine learning: opportunities and challenges for marketing. *Journal of Marketing Theory and Practice*, 2021.
12. Hammami, Z., Sayed-Mouchaweh, M., Mouelhi, W. et al. Neural networks for online learning of non-stationary data streams: a review and application for smart grids flexibility improvement. *Artificial Intelligence Review*, 53, pp. 6111–6154, 2020.
13. Hanea, A.; Nane, G.; Wielicki, B.; Cooke, R. Bayesian networks for identifying incorrect probabilistic intuitions in a climate trend uncertainty quantification context. *Journal Risk Analysis*, Vol. 21, pp. 1146–1161, 2018.
14. Jacobs, M.; Pradier, M.; McCoy Jr., T.; Perlis, R.; Velez, F.; Gajos, K. How machine-learning recommendations influence clinician treatment selections: the example of the antidepressant selection. *Translational Psychiatry*, Vol. 11, 2021.
15. Kabir, S.; Papadopoulos, Y. Applications of Bayesian networks and Petri nets in safety, reliability, and risk assessments: A review. *Safety Science*, Vol. 115, pp. 154-175, 2019.
16. Kwon, H.; Kim, H.; Lyuh, C.; Kim, J.; Han, J.; Kwon, Y. AIWareK: Compiling PyTorch Model for AI Processor Using MLIR Framework. 2022 IEEE 4th International Conference on Artificial Intelligence Circuits and Systems (AICAS), Incheon, Korea, Republic of, pp. 463-465, 2022.



17. Lawrence, J.; Hossain, N.; Jaradat, R.; Hamilton, M. Leveraging a Bayesian network approach to model and analyze supplier vulnerability to severe weather risk: A case study of the U.S. pharmaceutical supply chain following Hurricane Maria. *International Journal of Disaster Risk Reduction*, Vol. 49, 2020.
18. Lemos, S. *Inteligência Artificial e Gestão da Mudança em PMEs: Análise Dinâmica de Iniciativas de Adaptação*. Dissertação de mestrado, Instituto Universitário de Lisboa, 2022.
19. Lemos, S.; Ferreira, F.; Zopounidis, C.; Galariotis, E.; Ferreira, N. Artificial intelligence and change management in small and medium-sized enterprises: an analysis of dynamics within adaptation initiatives. *Annals of Operations Research*, 2022.
20. Ma, L.; Sun, B. Machine learning and AI in marketing – Connecting computing power to human insights. *International Journal of Research in Marketing*, Vol. 37, pp. 481–504, 2020.
21. Mathar, D.; Gaur, M. Change Management: Identifying Change Agents Using Social Network Analysis in an ERP Implementation. *International Journal of Computer Engineering & Technology (IJCET)*, 2020.
22. Mirjalili, S. Evolutionary Radial Basis Function Networks. In *Studies in Computational Intelligence*, pp. 105–139, 2019.
23. Missaggia, A.; Caetano, N.; Silva, D.; Ruppelt, M. Tomada de decisão multicritério aplicada a biocombustíveis. *Exacta – Engenharia de Produção*, 2020.
24. Paschen, U.; Pitt, C.; Kietzmann, J. Artificial intelligence: Building blocks and an innovation typology. *Business Horizons*, Vol. 63, Issue 2, pp. 147-155, 2020.
25. Pham, et al. A Case Study of Human-AI Interactions Using Transparent AI-Driven Autonomous Systems for Improved Human-AI Trust Factors. 2022 IEEE 3rd International Conference on Human-Machine Systems (ICHMS), Orlando, FL, USA, 2022.
26. Pereira, J.C.; Rego, R.; Zotes, L.; Lima, G.; Quelhas, O. Probabilistic risk analysis of safety management system failure and impact on economic performance: The case of jet engine manufacturing. *International Journal of Management and Decision Making*, Vol. 14, No. 4, pp. 345-372, 2015.
27. Polenghi, A.; Cattaneo, L.; Macchi, M. A framework for fault detection and diagnostics of articulated collaborative robots based on hybrid series modelling of Artificial Intelligence algorithms. *Journal of Intelligent Manufacturing*, 2023.
28. Samuel, J.; Kashyap, R.; Samuel, Y.; Pelaez, A. Adaptive cognitive fit: Artificial intelligence augmented management of information facets and representations. *International Journal of Information Management*, No. 65, 2022.
29. Tjoa, E.; Guan, C. A Survey on Explainable Artificial Intelligence (XAI): Toward Medical XAI. *IEEE*, 2020.
30. Vishwakarma, L.P.; Singh, R.K. An Analysis of the Challenges to Human Resource in Implementing Artificial Intelligence, (Ed.) *The Adoption and Effect of Artificial Intelligence on Human Resources Management, Part B (Emerald Studies in Finance, Insurance, and Risk Management)*, Emerald Publishing Limited, Bingley, pp. 81-109, 2023.
31. Wainwright, D.; Crawford, J.; Loretto, W.; Phillipson, C.; Robinson, M.; Shepherd, S.; Vickerstaff, S.; Weyman, A. Extending working life and the management of change. Is the workplace ready for the ageing worker? *Ageing and Society*, Vol. 39, No. 11, pp. 2397-2419, 2019.
32. Wijayati, D.T.; Rahman, Z.; Fahrullah, A.; Rahman, M.F.W.; Arifah, I.D.C.; Kauts, A. A study of artificial intelligence on employee performance and work engagement: the moderating role of change leadership. *International Journal of Manpower*, Vol. 43, No. 2, pp. 486-512, 2022.

33. Zhang, J.; Petersen, S.; Radivojevic, T. et al. Combining mechanistic and machine learning models for predictive engineering and optimization of tryptophan metabolism. *Nature Communications*, Vol. 11, pp. 4880, 2020[a].
34. Zhang, R.; Li, X.; Zhang, X.; Qin, H.; Xiao, W. Machine learning approaches for elucidating the biological effects of natural products. *Natural Product Reports*, 2020[b].\*
35. Zhang, X. *Machine Learning. A Matrix Algebra Approach to Artificial Intelligence*, pp. 223-440, 2020.

# ECONOMIC AND SOCIAL CONSEQUENCES OF FICTITIOUS TRADES IN THE SLOVAK REPUBLIC

**Peter Sika**

*University of Economics in Bratislava, Slovak Republic  
peter.sika@euba.sk*

## **ABSTRACT**

*The Slovak Republic has a high proportion of so-called fictitious tradesmen on the labour market, as evidenced by data not only from Eurostat, but also from the Social Insurance Institution. According to statistical data, the number of fictitious tradesmen in Slovakia has increased over the last ten years from 84 thousand to almost 110 thousand. The exact number cannot be determined, but there are ways of estimating it. According to the profesia.sk portal, most job offers indicating the employment of fictitious tradesmen are in manufacturing, transport and construction. As tradesmen pay 6 times less tax and tax payments on the total price of the work for the first year of the trade and 2.3 times less for the following years of the trade, the budget of the Social Insurance Institution as well as the state loses significant sources of revenue. The benefits of the so-called bogus trades are exploited by companies in the form of reduced levy obligations, but employees lose their rights to protection and, at the same time, the adequate amount of future pension benefits as well as benefits from the social security system. The aim of this paper is to examine the reasons and motives for the use of 'bogus trades' and to try to identify measures that will eliminate the use of bogus trades and contribute to a fair level of pension benefits. A Slovak fictitious tradesman who pays minimum contributions is entitled to a minimum pension under Slovak legislation, even though the amount of the pension will not correspond to the contributions paid. This has implications for the fairness and sustainability of the pension system.*

**Keywords:** *Fictitious trades, Retirement benefit, Slovak Republic, Social consequences*

## **1. INTRODUCTION**

The Slovak Republic is adapting its social protection system to changing conditions in the context of anticipated demographic changes as well as the labour market situation. The COVID-19 pandemic revealed certain deficiencies in access to social protection, particularly for the self-employed. In recent years, the Slovak labour market has achieved historically the best results. According to the Statistical Yearbook of the Slovak Republic (SO SR, 2023), in 2022 the number of economically active persons reached 2,774.3 thousand persons. The number of employed persons reached 2,603.9 thousand. Sole traders constitute the majority of all business entities in Slovakia, with nearly 379 thousand active sole traders in the third quarter of last year. The number of unemployed was 170.4 thousand. The economic activity rate of the population aged 15-89 reached 61.7%. Despite the relatively favourable labour market situation, there is an increasing trend of forcing employees to perform dependent work<sup>1</sup> through self-employment<sup>2</sup>. This is particularly prevalent in the construction, agriculture, retail, and services sectors.

---

<sup>1</sup> § 1, paragraph 2 of Act No. 311/2001 Coll., the Labour Code: "Dependent work is work performed in a relationship of subordination between the employer and the employee, personally by the employee for the employer, according to the employer's instructions, in the employer's name, during working hours determined by the employer".

<sup>2</sup> § 3 of Act No. 455/1991 Coll. on Trade Licensing: "A trade is a continuous activity operated independently, in one's own name, on one's own responsibility, for the purpose of achieving profit, and under the conditions established by this law."

Country		Country		Country	
Greece	27 %	Portugal	13 %	Bulgaria	10 %
Italy	20 %	France	12 %	Estonia	10 %
Poland	18 %	Croatia	12 %	Latvia	10 %
Czech Republic	16 %	Ireland	12 %	Austria	10 %
Belgium	15 %	Lithuania	12 %	Cyprus	9 %
Holland	15 %	Hungary	12 %	Luxembourg	9 %
Malta	15 %	Romania	12 %	Sweden	9 %
Slovak Republic	15 %	Slovenia	12 %	Denmark	8 %
Spain	15 %	Finland	11 %	Germany	8 %

*Table 1: Share of self-employed persons in total employment (% , 2022)  
(Source: CEDEFOP:EUROPA.EU)*

The existence of fictitious sole traders results in the non-payment of contributions and taxes in the appropriate amounts, which, in the long term, leads to lower pension payments for sole traders and deepens the deficit in the pension fund of the Social Insurance Agency. Tax shortfalls translate into lower shared taxes, which local governments lack to fulfil their obligatory duties towards their citizens. At the same time, this leads to reduced social protection and lower job security. According to the Institute for Financial Policy, 19% of sole traders do not pay their insurance premiums correctly, leading to an accumulation of their debt on social insurance amounting to a total of €63 million annually (IFP, 2024). From an economic perspective, the evasion of contributions and taxes can manifest in a positive multiplier effect, for example, in higher consumption, which is conditioned by higher income. The aim of the article is to explore the reasons and motivations for the use of so-called fictitious sole traders and to attempt to identify measures that will eliminate the use of fictitious sole traders and contribute to a fair level of pension benefits.

## **2. THEORETICAL BACKGROUND**

Fictitious sole trading is carried out through contracts that differ from traditional employment contracts. According to Heyes and Hastings (2017), their income depends on one or a small number of clients, and they receive direct instructions on how to perform the work. In scientific literature, fictitious sole trading is referred to by various definitions. For example: dependent self-employment (Thörnquist, 2013), fictitious self-employment (Hatfield, 2015), false self-employment (ILO, 2020), quasi-self-employment (Mandrone et al., 2014), and disguised employment (Grus, 2005). According to Eurofound (2013), a self-employed person without employees (a fictitious self-employed person) is someone who does not meet at least two criteria, namely: a) has more than one client for whom they work, fulfilling the criterion of autonomy; b) is capable of hiring employees if necessary, fulfilling the criterion of subcontracting; c) is independent in making important decisions, meaning they fulfil the criterion of autonomy in decision-making authority. Williams and Horodnic (2017) noted that fictitious self-employed individuals experience a reduction in job skills because their employers lack motivation to invest in their professional training. Jorens (2008) points out that many fictitious self-employed individuals pay minimal or no social contributions. Milanez and Bratta (2019) observe that the use of fictitious self-employed individuals responds to changes in the tax and contribution system. The Statistical Office of the Slovak Republic has been monitoring the number of fictitious self-employed individuals since 2010 based on the results of the Labour Force Selection Survey. These figures represent estimates extrapolated from a sample of 10,250 households. According to these results, the number of fictitious self-employed individuals in Slovakia has increased from 84,000 in 2010 to 107,000 in 2021 (ŠÚ SR, 2010-2022).

These data indicate that currently, the activities of every third self-employed individual in Slovakia exhibit characteristics of dependent employment (SBA, 2022).

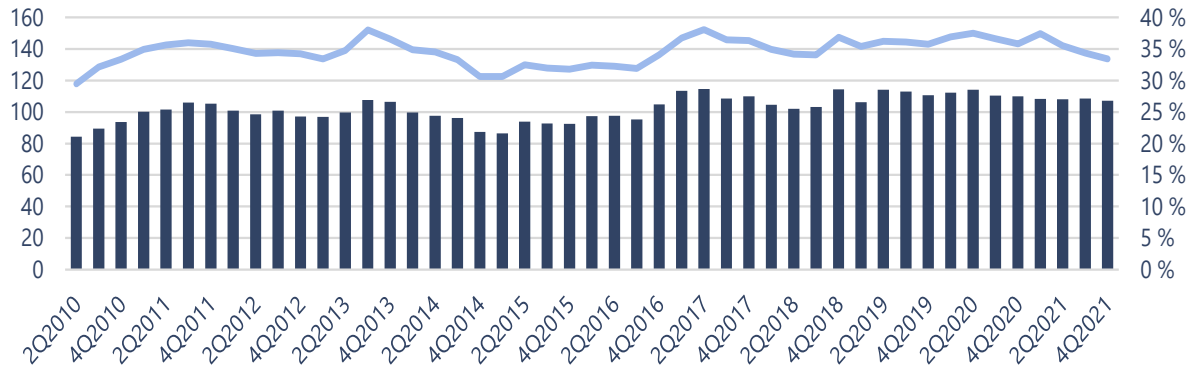

*Figure 1: Selective labour force surveys in the period 2Q 2010 to 4Q 2021*  
*Notes: Number of fictitious self-employed persons in thousand (left axis). Share of fictitious self-employed people to entrepreneurs with no employees (right axis)*  
*(Source: Statistical Office Of The Slovak Republic)*

High proportion of self-employed individuals with a dominant client in Slovakia is also confirmed by OECD data for the year 2019, indicating that 28.7% of self-employed individuals had a dominant client, whereas the OECD average was 15.9% (Onisik, M., Vitáloš, M., Zeman, J., 2023).

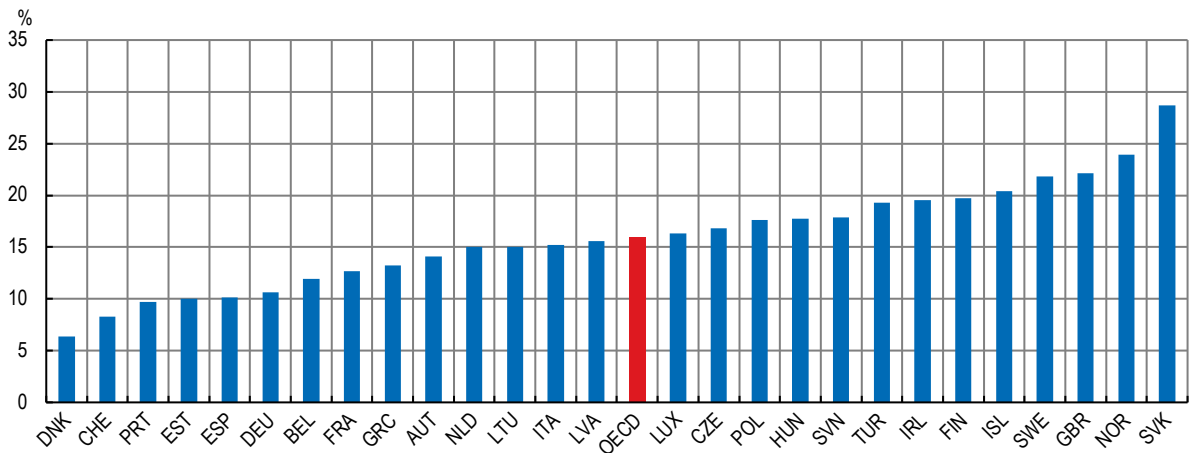

*Figure 2: The incidence of own-account workers who generally have one dominant client (percentage of self-employed, 2017)*  
*Note: OECD unweighted average of countries shown*  
*(Source: OECD Employment Outlook 2019)*

### 3. METHODOLOGY

Despite a favourable labour market situation in Slovakia, the country holds a leading position in the statistics of using fictitious self-employment. This phenomenon involves underpayment or non-payment of contributions and taxes, which, over the long term, results in lower pension pay-outs for self-employed individuals. Additionally, it leads to reduced social protection and lower job security. The aim of this contribution is to highlight the reasons and motivations for the use of so-called fictitious self-employment and its impact on pension benefits.

In order to achieve the goal, we employed classical scientific methods such as the method of comparing knowledge from available literary sources and the method of analysing existing approaches, excerpting common and conflicting viewpoints. Additionally, we used the deductive method to justify individual conclusions.

#### 4. RESULTS

The use of fictitious self-employment not only brings benefits for employers and the self-employed themselves but also has broader societal and individual negative impacts. Among the advantages cited by the self-employed are greater freedom and flexibility. A significant advantage for self-employed individuals compared to employees is that they can deduct 60% of their earnings as lump-sum expenses, which employees cannot. This legislative provision widens the tax and contribution gap between employees and self-employed individuals, leading to an increase in the number of so-called fictitious self-employed individuals. Consequently, they pay contributions based on a minimum assessment base, unlike self-employed individuals who are not required to contribute to mandatory pension insurance. The amount of minimum social contributions depends on the average monthly wage in the economy of the Slovak Republic determined by the Statistical Office for the calendar year two years prior to the relevant period. The minimum assessment base represents 50% of the average monthly wage from two years ago, while the maximum assessment base is set at seven times the average monthly wage from the same period<sup>3</sup>. The obligation to pay contributions to the Social Insurance Agency arises for a self-employed individual after submitting the first tax return following the calendar year in which the individual earned income from business activities or other self-employment exceeding 12 times the minimum monthly assessment base<sup>4</sup>. From the above, it follows that in certain cases, a starting self-employed individual has the opportunity to defer paying social contributions for up to 18 months, with no contribution obligation in the first year of self-employment. The tax and contribution burden on labour in the Slovak Republic is relatively high. An employee pays income tax at a rate of 19% and social and health insurance contributions totalling 13.4%. Additionally, the employer pays contributions for the employee at a rate of 35.2%. Consequently, the total cost of employing a worker includes contributions amounting to 48.6% and a 19% income tax burden. A self-employed individual pays social contributions at a rate of 33.15% and health insurance contributions at a rate of 15% (individuals with disabilities pay 7.5%) based on the minimum assessment base of €652. Income tax is set at 15% if taxable income (revenue) in 2024 does not exceed €60,000. According to data from the Social Insurance Agency, the proportion of self-employed individuals paying contributions based on the minimum assessment base has increased from 66% in 2015 to nearly 80% in 2022. This equates to an average of 148,000 self-employed individuals. At the same time, approximately half of self-employed individuals do not have mandatory social insurance obligations. This means they are not entitled to old-age or disability pensions, sickness benefits, or other social insurance benefits.

Year	2015	2020	2022
The number of self-employed persons paying minimum levies	142 634	149 361	155 818
% of all paying entrepreneurs	66.30 %	80.25 %	79.76 %

*Table 2: Number of self-employed persons paying social contributions from the minimum assessment base*

*(Source: processed on the basis of data from the Social Insurance Company)*

<sup>3</sup> The minimum assessment basis for 2024 is €652 (50% of €1,304) and the maximum assessment basis for 2024 is €9,128 (7 x €1,304).

<sup>4</sup> As of July 1, 2024, the self-employed person is required to pay contributions to the Social Insurance Company after reaching the income reported in the tax return for the year 2023 of more than €7,824 (12 x €652).

Among the individual disadvantages, we include reduced labor rights protection, such as the absence of notice periods, and reduced entitlements and obligations regarding social insurance in cases of job loss, illness, or retirement. Another disadvantage for self-employed individuals compared to employees is the increased administrative burden and the need to monitor legislative changes (since 2011, the Labour Code has been amended thirty-one times), which employers typically manage in an employment relationship. Self-employed individuals do not have the right to have medical visits reimbursed or to accompany a family member to appointments. They are not obligated to pay unemployment insurance, but this results in the consequence that if they cease their business activities, they are not eligible for unemployment benefits. A self-employed individual cannot be insured for health damage or death due to occupational injury or illness with the Social Insurance Agency. However, they can opt for accident insurance with a commercial insurer, which will vary in cost depending on the assessed risk. Low contributions to the social security system can have significantly negative consequences on the amount of retirement pension received in the end, potentially falling below the minimum pension threshold. Addressing this shortfall may necessitate contributions from the entire society. In Slovakia, the calculation of pension benefits considers the period of pension insurance and the ratio of the assessment base to the average wage. Consequently, if a self-employed individual does not pay social contributions, this period is not counted towards their pension, impacting the amount of pension benefits they receive. Similarly, if a self-employed individual pays social contributions based only on the minimum assessment base, this can result in a lower pension benefit, potentially falling below the minimum pension threshold. Since July 1, 2015, according to §82b of the Social Insurance Act, the amount of old-age and invalid pensions paid upon reaching retirement age has been gradually increased to the level of the minimum pension. In October 2023, this affected approximately 102,000 pensions. The purpose of increasing the pension to the minimum level is to ensure that the insured individual has a pension income sufficient to prevent them from relying on material assistance. According to the Ministry of Labour, Social Affairs and Family of the Slovak Republic, the introduction of the minimum pension was adopted as a socio-economic measure. However, the aim of supplementing pensions to the minimum level is not to universally protect the standard of living of all pensioners, as evidenced by the requirement of having at least 30 years of pension insurance to qualify. The general purpose of this measure is to prevent insured individuals who have worked for many years from falling into material need in old age. The increase is determined as the difference between the minimum pension and the pension currently received, or the total pension income of the pension recipient. The amount of the minimum pension is set at 145% of the subsistence minimum for a single adult person valid as of January 1 of the calendar year<sup>5</sup> in which the old-age or invalid pension amount is determined, provided that the insured has accumulated 30 years of pension insurance, regardless of the amount of contributions paid. Since October 1, 2023, the amount of the minimum pension is €389.90 per month. The basic percentage amount of the minimum pension, set at 145%, further increases by: 2.5% for 31 to 39 years of pension insurance; 3.0% for 40 to 49 years; 5.0% for 50 to 59 years; and 7.5% for 60 years and each additional year of pension insurance thereafter. This reflects the principle of merit in the mechanism of the minimum pension. The expenses incurred to increase pension amounts to the minimum pension level totalled €65.086 million in 2022. The Social Insurance Act in § 23 allows for the establishment and termination of voluntary pension insurance, which would lead to an increase in future pension benefits for self-employed individuals. The voluntary pension package does not only allow payment for old-age insurance. Besides old-age insurance, the voluntary pension package includes disability insurance and contributions to the solidarity reserve fund.

---

<sup>5</sup> In the period from October 1, 2023 to December 31, 2024, the amount of the minimum pension is linked to the amount of the subsistence minimum valid as of July 1, 2023, which is the amount of €268.88.

If a self-employed person chooses the voluntary pension package, they would contribute 18% of the increased assessment base to old-age insurance, 6% to disability insurance, and 4.75% to the solidarity reserve fund. Voluntary contributions can be included as expenses by the self-employed person, thereby reducing their taxable income base. Another way for self-employed individuals to increase their pension benefits is through voluntary contributions to retirement savings under § 20 of Act No. 43/2004 Coll. on Pension Savings, as amended. The frequency and amount of voluntary contributions are determined by the saver themselves. A disadvantage is that currently, voluntary contributions to retirement savings cannot be used to reduce the taxable income base. Fictitious trades not only impact the social system but also the healthcare system, which operates on solidarity principles and is based on public health insurance. Access to healthcare is provided to the entire population. It follows from the above that with fictitious trades, utilizing payments based on the minimum assessment base, citizens can qualify for minimum pensions, which is not entirely correct since their benefits do not correspond to the contributions made. However, in terms of healthcare, citizens receive the same medical care as employees who have contributed significantly more to the healthcare system, simply because they did not have the option to voluntarily choose the assessment base, which legislation allows for self-employed individuals. Thus, employees subsidize the healthcare of fictitious trades (Adam, Miller, Pope, 2017). Illegal practices in the form of forced trades further incur consequences in the form of monetary or non-monetary fines. Such illegal practices fall under illegal employment. An employee engaged in illegal employment may face a fine of €331. An employer utilizing illegal employment may be fined between €2,000 and €20,000 by the labour inspectorate. Additionally, the employer faces non-financial sanctions such as publication on the website of the National Labour Inspectorate in a publicly accessible list of entities that violated the prohibition of illegal employment. Furthermore, in case of repeated violation of the law, the entrepreneur may have their trade license revoked. Illegal employment also impacts the ability to obtain subsidies or participate in public procurement.

## **5. CONCLUSION**

The European Pillar of Social Rights states that workers have the right to fair and equal treatment regarding access to social protection, regardless of the type of employment relationship. However, the current setup of the contribution system tends to favour fictitious self-employment over regular employment contracts. For this reason, legislative changes are needed to equalize the contribution burdens across different entities, while considering the specificities of self-employment. Such a legislative change would contribute to levelling the competitive environment among business entities that exploit a competitive advantage by avoiding costs through the use of fictitious self-employed individuals. It would also improve the living standards of workers currently engaged in so-called fictitious self-employment, as they would gain greater social and labour protection, as well as access to higher social and pension benefits. However, the state must also realize that creating a favourable business environment and minimizing excessive bureaucracy are essential for business development and economic growth, thereby enhancing competitiveness and a favourable entrepreneurial climate. It is necessary to increase awareness of the risks and benefits of fictitious self-employment because, in the short term, flexibility and higher net income are more appealing. However, in the long term, this decision has a negative impact on social benefits with consequences for the worker's standard of living. Broad societal awareness of the issue of fictitious self-employment would stimulate discussion, as some employers using fictitious self-employed individuals may not even realize they are acting illegally and violating the Labour Code, while the self-employed themselves may not fully comprehend the impacts, both individually and societally. Public authorities (Ministry of Labour, Social Affairs and Family of the Slovak Republic; Ministry of Finance of the Slovak Republic; National Labour Inspectorate; Financial Administration;



Social Insurance Agency; Health Insurance Companies, etc.) should communicate proactively and in a coordinated manner about the problem – the communication should clearly describe the societal issues arising from the use of fictitious self-employed individuals and the threats of sanctions that entities expose themselves to (Haluša, Marek, Murín, Laczkó, 2024). By not addressing the issue of fictitious self-employment, the state budget loses significant financial resources and must also allocate funds to cover deficits in the pension fund. The healthcare costs of fictitious self-employed individuals are subsidized by the health contributions of employees and their employers. Setting clear legal standards and obligations would eliminate the shadow economy, increase fairness, and ultimately enhance the standard of living of citizens.

**ACKNOWLEDGEMENT:** *The paper is the output of the research grant VEGA No. 1/0226/23 „Socio-economic challenges and opportunities related to aging policy to ensure sustainable economic growth and innovation“.*

#### LITERATURE:

1. Adam, S, Miller, H., Pope, T. (2017). *Tax, legal form and the gig economy*. London: The IFS. ISBN 978-1-911102-33-5. Dostupné na: <https://ifs.org.uk/books/tax-legal-form-and-gig-economy>.
2. Eurofound (2013). *Self-employed or not self-employed? Working conditions of economically dependent workers*. Dostupné na: <https://www.eurofound.europa.eu/en/publications/2013/self-employed-or-not-self-employed-working-conditions-economically-dependent>.
3. Grus, Z. (2005). Švarcsystém v rozhodovaci praxi a nový zákon o zaměstnanosti. In: Právní rozhledy: Časopis pro všechna právní odvětví. 2005, roč. 13, č. 1, s. 18-22. Dostupné na: <http://www.beck-online.cz/legalis/document-view.seam?type=html&documentId=nrptembqgvpxa4s7gfpxg5dsl4ytq&conversationId=966995#sele>.
4. Haluša, M., Marek, A., Murín, M., Laczkó, A. (2024). *Hľadáme spoľahlivého zamestnanca. Podmienka: na živnosť*. Bratislava: Útvar hodnoty za peniaze. Dostupné na: [https://www.mfsr.sk/files/sk/financie/hodnota-za-peniaze/analyzy-uhp/fiktivni\\_zivnostnici\\_komentar-uhp\\_maj2024.pdf](https://www.mfsr.sk/files/sk/financie/hodnota-za-peniaze/analyzy-uhp/fiktivni_zivnostnici_komentar-uhp_maj2024.pdf).
5. Hatfield, I. (2015). *Self-employment in Europe*. Dostupné na: [https://ippr-org.files.svdcn.com/production/Downloads/self-employment-Europe\\_Jan2015.pdf](https://ippr-org.files.svdcn.com/production/Downloads/self-employment-Europe_Jan2015.pdf).
6. Heyes, J., Hastings, T. (2017). *The Practices of Enforcement Bodies in Detecting and Preventing Bogus Self-Employment*. Dostupné na: <https://www.ela.europa.eu/sites/default/files/2021-09/Study%20Practices%20of%20enforcement%20bodies%20detecting%20preventing%20bogus%20self%20employment.pdf>.
7. IFP (2024). *Odhal' ma, ak to dokážeš: Ako motivovať živnostníkov k platbe poisteného?* Ministerstvo financií SR, Inštitút finančnej politiky. Dostupné na: <https://ifp.sk/odhal-ma-ak-to-dokazes-ako-motivovat-zivnostnikov-k-platbe-poistneho/>.
8. ILO (2020). *Ensuring better social protection for self-employed workers. Paper prepared for the 2nd Meeting of the G20 Employment Working Group under Saudi Arabia's presidency*. Dostupné na: <https://www.ilo.org/media/400681/download>.
9. Jorens, Y. (2008). *Self-employment and bogus self-employment in the European construction industry. A comparative study of 11 Member States*. Dostupné na: <https://backoffice.biblio.ugent.be/download/1144944/1201538>.
10. Mandrone, E. a kol. (2014). *Is decline in employment the outcome or cause of crisis in Italy?* Dostupné na: [https://www.researchgate.net/publication/323976994\\_Is\\_Decline\\_in\\_Employment\\_the\\_Outcome\\_or\\_Cause\\_of\\_Crisis\\_in\\_Italy](https://www.researchgate.net/publication/323976994_Is_Decline_in_Employment_the_Outcome_or_Cause_of_Crisis_in_Italy).

11. Milanez, A., Bratta, B. (2019). *Taxation and the future of work: How tax systems influence choice of employment form*. OECD Taxation Working Papers, No. 41, OECD Publishing, Paris. Dostupné na: <https://www.oecd-ilibrary.org/docserver/20f7164a-en.pdf?expires=1718009368&id=id&accname=guest&checksum=E77E8243CBB4FAE74F825BB5B263E745>.
12. OECD (2019): *OECD Employment Outlook 2019. The Future of Work*. Dostupné na: <https://doi.org/10.1787/9ee00155-en>.
13. Onisik, M., Vitáloš, M., Zeman, J. (2023): *(Ne)samostatne zárobkovo činné osoby*. Najvyšší kontrolný úrad Slovenskej republiky, Júl 2023. Dostupné na: <https://www.nku.gov.sk/documents/33855/34228/%28Ne%29samostatne%20z%C3%A1robkovo%20%C4%8Dinn%C3%A9%20osoby.pdf/283c5cc7-80fc-c823-30e4-7b5cea9507a2>.
14. SBA (2022): *Aktuálne podmienky zastretených pracovných pomerov na Slovensku*. Bratislava: Slovak Business Agency. Dostupné na: <https://monitoringmsp.sk/wp-content/uploads/2022/08/Aktu%C3%A1lne-podmienky-zastret%C3%BDch-pracovn%C3%BDch-pomerov-na-Slovensku-FINAL.pdf>.
15. Štatistický úrad Slovenskej republiky (2010-2022): *Výsledky výberového zisťovania pracovných síl v SR*. Bratislava: Štatistický úrad Slovenskej republiky 2010-2022.
16. Štatistický úrad Slovenskej republiky (2023): *Štatistická ročenka Slovenskej republiky 2023*. Bratislava: Štatistický úrad Slovenskej republiky. Dostupné na: [https://slovak.statistics.sk/wps/portal/ac0b4f4e-9dff-4588-ab3a-3ee285fec7a5!/ut/p/z/rVPLdtowFPyWlRlUurIkW17akNomQGuoeXjTI7-CajAkOE7o11ec9AG0gBf1QpZ05o7ujEY4xnMcV7JRj7JWm0qu9HoRm19DKxCuSxwAi\\_cg6Ee90JvYBBjg2SlAjMb3EHxxPnvjPtMAjuOT-uFDFwIa-KHrjAkjBp7iGMdpVW\\_rJV5skp1col2Jti\\_JhehhpUqZqvwOml1el\\_vjHZlCwgqWlzsCsS4EEgmVCKa54bgRZ5akh-4t6nK8KIV-kzL383Gbbzoeo7PrAGAGHGcAsePxnZIKTj0lhfv9XDhc6Bd\\_ZUG4-v0s4NfNxC4ngHOGYEYtgbTKXhT46NukngwiiIAbv0EHAwm50JgDaxQBC795Bp4oVVYF2X6BM8alb\\_iquo8r3VCJ38uORO0KIw0QWaWSMSsIkeJSDJEMspTkXGZcBv7gPs4Vsm685quO9AhQpiCgUk4ZxaxwTxkXn17eoodHcxNVedvNZ7\\_TqaqCiTLWuevrFWj6r3-v8iVnvwK6dFGq4b0ccbzsDt81DJkvTyCsMHzMy48b8V17t1pAh6My961eiCnxhnCMplBmLANqfXfftl\\_rfbrUq3a6jtaB7pRQqx\\_53d4S8mdgVw3vKV83A-fADVoyPmw!!/dz/d5/L2dBISEvZ0FBIS9nQSEh/](https://slovak.statistics.sk/wps/portal/ac0b4f4e-9dff-4588-ab3a-3ee285fec7a5!/ut/p/z/rVPLdtowFPyWlRlUurIkW17akNomQGuoeXjTI7-CajAkOE7o11ec9AG0gBf1QpZ05o7ujEY4xnMcV7JRj7JWm0qu9HoRm19DKxCuSxwAi_cg6Ee90JvYBBjg2SlAjMb3EHxxPnvjPtMAjuOT-uFDFwIa-KHrjAkjBp7iGMdpVW_rJV5skp1col2Jti_JhehhpUqZqvwOml1el_vjHZlCwgqWlzsCsS4EEgmVCKa54bgRZ5akh-4t6nK8KIV-kzL383Gbbzoeo7PrAGAGHGcAsePxnZIKTj0lhfv9XDhc6Bd_ZUG4-v0s4NfNxC4ngHOGYEYtgbTKXhT46NukngwiiIAbv0EHAwm50JgDaxQBC795Bp4oVVYF2X6BM8alb_iquo8r3VCJ38uORO0KIw0QWaWSMSsIkeJSDJEMspTkXGZcBv7gPs4Vsm685quO9AhQpiCgUk4ZxaxwTxkXn17eoodHcxNVedvNZ7_TqaqCiTLWuevrFWj6r3-v8iVnvwK6dFGq4b0ccbzsDt81DJkvTyCsMHzMy48b8V17t1pAh6My961eiCnxhnCMplBmLANqfXfftl_rfbrUq3a6jtaB7pRQqx_53d4S8mdgVw3vKV83A-fADVoyPmw!!/dz/d5/L2dBISEvZ0FBIS9nQSEh/).
17. Thörnquist, A. (2013). *False (Bogus) Self-Employment in East-West Labour Migration. Recent trends in the Swedish construction and road haulage industries*. Dostupné na: [https://www.academia.edu/88032818/False\\_Self\\_Employment\\_and\\_Other\\_Precarious\\_Forms\\_of\\_Employment\\_in\\_the\\_Grey\\_Area\\_of\\_the\\_Labour\\_Market?uc-sb-sw=5180992](https://www.academia.edu/88032818/False_Self_Employment_and_Other_Precarious_Forms_of_Employment_in_the_Grey_Area_of_the_Labour_Market?uc-sb-sw=5180992).
18. Williams, C., Horodnic, I. (2017). *Tackling bogus self-employment: Some lessons from Romania*. Dostupné na: <https://www.worldscientific.com/doi/10.1142/S108494671750011X>.
19. Act No. 455/1991 Zb. o živnostenskom podnikaní (živnostenský zákon). Dostupné na: <https://www.slov-lex.sk/pravne-predpisy/SK/ZZ/1991/455/>.
20. Act No. 311/2001 Z.z. Zákonník práce v znení neskorších predpisov. Dostupné na: <https://www.slov-lex.sk/pravne-predpisy/SK/ZZ/2001/311/>.
21. Act No. 461/2003 Z.z. o sociálnom poistení v znení neskorších predpisov. Dostupné na: <https://www.slov-lex.sk/pravne-predpisy/SK/ZZ/2003/461/>.
22. Act No. 43/2004 Z.z. o starobnom dôchodkovom sporení v znení neskorších predpisov. Dostupné na: <https://www.zakonypreludi.sk/zz/2004-43>.

# THE INTERSECTION OF ARTIFICIAL INTELLIGENCE AND GREEN AND SUSTAINABLE INSURANCE: A PRISMA COMPLIANT ANALYSIS AND LITERATURE REVIEW

**Katerina Fotova Cikovic**

*University North, Croatia*

*Trg dr. Žarka Dolinara 1, 48000 Koprivnica, Croatia*

*kcikovic@unin.hr*

**Marin Milkovic**

*University North, Croatia*

*Trg dr. Žarka Dolinara 1, 48000 Koprivnica, Croatia*

*mmilkovic@unin.hr*

**Martina Hajdek**

*Sveučilište u Zagrebu, Grafički fakultet, Getaldićeva 2, 10000 Zagreb, Croatia*

*martina.hajdek@grf.unizg.hr*

## **ABSTRACT**

*Artificial intelligence (AI) is currently the most prominent technological advance digitally transforming the world and all the business industries. In this study, the main objective is to survey, identify and analyse the relevant published studies and their findings regarding the application of AI and AI-based technologies in green/sustainable insurance. For that purpose, one of the most relevant scientific databases (i.e. the Scopus scientific database) was surveyed in search of published relevant work regarding green/sustainable insurance and Artificial Intelligence (AI). The SLR (systematic literature review) method has been applied, in compliance with the PRISMA (Preferred Reporting Items for Systematic Reviews and Meta-Analyses) guidelines. The keywords/key terms „GREEN INSURANCE“ or „SUSTAINABLE INSURANCE“ AND „ARTIFICIAL INTELLIGENCE“ were applied to the Scopus scientific database. The results of this study consist of insights and trends in the academic literature regarding the implementation of AI in green/sustainable insurance and have important practical and academic implications and reveal the hotspots and trends in the use of Artificial Intelligence in green finance in general. The findings of the surveyed papers are provided in a narrative synthesis. This could further expand this already topical subject, as there is a growing interest in incorporating AI in all fields of finance and all financial sectors globally. Therefore, this study could represent a stepping stone and one step further in this direction.*

**Keywords:** *Artificial Intelligence, green finance, fintech, sustainability, sustainable fintech, PRISMA, systematic literature review*

## **1. INTRODUCTION**

Insurance companies are vital institutional investors with large investment portfolios that are a crucial part of the financial sector and „contribute to economic development and financial market dynamics“ and are „key institutional investor in the EU“ (Krišto et al., 2023). However, the insurance sector is perceived to be „farther away from any of the sustainability dimensions defined by the United Nations Sustainable Development Goals“ (United Nations 2015; Stricker et al., 2022). The insurance industry is currently facing fierce competition from tech giants as well as from efficient startup entities which use the power of technology to their maximum advantage. This „use of technology to enhance the customer experience, claims management, underwriting and pricing efficiency is normally referred to as InsurTech“ (Pirootta et al., 2022).

The use of AI-based technology in insurance (as well as the whole financial sector) is inevitable and is embraced by insurance companies in developed and developing countries. Technologies are driving the growth and development of the financial and insurance sector through their innovative apps, models, online portals etc and are “disrupting for a decade”, in the form of FinTech and InsurTech (Ratnakaram et al., 2020). The efficiency of insurance companies is vital, and this is especially true in developing countries since they take up a big portion of the financial system. Insurers are also „one of the key intermediaries in modern financial systems of developed market economies“, who happen to be large investors in financial instruments (Perčević, 2023). The use of AI tools and AI technology, which is blooming throughout all industries, could help achieve, improve and sustain efficiency. Therefore, the main aim of this paper is to survey, identify and analyse the relevant published studies and their findings regarding the application of AI and AI-based technologies in green/sustainable insurance. For that purpose, one of the most relevant scientific databases (i.e. the Scopus scientific database) was surveyed in search of published relevant work regarding green/sustainable insurance and Artificial Intelligence (AI). The SLR (systematic literature review) method has been applied, in compliance with the PRISMA (Preferred Reporting Items for Systematic reviews and Meta-Analyses) guidelines. The results of this study consist of insights and trends in the academic literature regarding the implementation of AI in green/sustainable insurance. The scientific contributions are twofold. First, this is among the very few studies that explore the trends and findings thus far regarding the implementations of AI technology in sustainable and green insurance. Second, and most importantly, the systematized findings of this literature review could become an inspiration for insurance company management to be involved in AI technology in order to keep up with global trends and improve business performance and efficiency. The structure of this paper is as follows. In the second section, a theoretical background on the Sustainable and green insurance concepts is given, as well as a theoretical background on the Artificial Intelligence (AI). Section 3 covers the methodology and research flow. In Section 4, the research results, i.e. the results from the systematic literature review are given. Section 5 is the last section, that opens up a discussion and concludes the paper.

## **2. THEORETICAL BACKGROUND**

In this section, a theoretical background on green and sustainable insurance and Artificial Intelligence (AI) is given as follows.

### **2.1. Sustainable/green insurance**

The term sustainability seems to be a „buzz“ term and concept that has many different definitions and is very topical in all research areas and all industries. The sustainability concept dates back to the Brundtland Commission (1987) report (Nogueira et al., 2018), where the base for the sustainability move was set. In essence, sustainable development and sustainability take into consideration the „interests of future generations without reducing current development“. Scordis et al. (2014) state the differences between the term sustainability and sustainable insurance and tackle the main issue in the Principles for Sustainable Insurance (PSI), which are not a call for stakeholder-focused insurers and present four principles a sustainable insurer should consider: „(1) embed in its decision making relevant environmental, social, and governance (ESG) issues; (2) work with clients and business partners to raise awareness of ESG issues, manage risk, and develop risk solutions; (3) work together with governments, regulators, and other key stakeholders to promote widespread action across society on ESG issues; and (4) demonstrate accountability and transparency in regularly disclosing publicly progress in implementing each of the preceding principles“.

The efficiency and performance of sustainable and green insurers is vital, therefore, supervisors and other stakeholders are interested in any potential deterioration in the insurance company's financial health and stability as early as possible. Suptech and AI tools enable different insurance stakeholders to discover and intervene promptly (Jagrič et al., 2023).

## **2.2. Artificial Intelligence (AI)**

The term Artificial Intelligence has noted a significant increase in interest by academic members, management board members and the public. It can be defined as a human-made tool that emulates the "cognitive" abilities of the natural intelligence of human minds and many scholars consider it to be „one of the most transformative technological developments in human history“ (Bennett, 2021; Garrett, 2024). The increasing human-like capabilities of AI are attracting attention in different areas of research. AI is expected to further „leverage machine learning algorithms, especially deep learning and reinforcement learning, to continue to create the kind of disruptive technologies required in every aspect of daily living that will significantly alter the way that consumers, industries or businesses operate“ (Akinsola et al., 2022). It is disrupting businesses, industries, travel, health and life overall, and is a change to be embraced by companies worldwide, in order to keep their competitive edge and prosper and improve performances. AI-based technologies could potentially „bring significant benefits to society and can be leveraged in various ways to improve people's lives“ (Tiwari, 2023). The vital role of AI is taken into consideration, and this was the main rationale for this paper: to dive into the possibilities that the intersection of green/sustainable insurance and AI could provide.

## **3. METHODOLOGY**

The main objective of this paper is to survey, identify and analyse the relevant published studies and their findings regarding the application of AI and AI-based technologies in green/sustainable insurance. For that purpose, one of the most relevant scientific databases (i.e. the Scopus scientific database) was surveyed in search of published relevant work regarding green/sustainable insurance and Artificial Intelligence (AI). The SLR (systematic literature review) method has been applied, in compliance with the PRISMA (Preferred Reporting Items for Systematic Reviews and Meta-Analyses) guidelines. The PRISMA guidelines include four phases, i.e. identification, screening, eligibility, and inclusion, as shown in Figure 1. In the first, so-called identification phase, the Scopus scientific database was surveyed with the combination of keywords: „SUSTAINABLE INSURANCE“ and „ARTIFICIAL INTELLIGENCE“ (which led to a total of 59 papers), and „GREEN INSURANCE“ and „ARTIFICIAL INTELLIGENCE“ (which led to 9 papers), i.e. a total of 68 papers. In the screening phase, which is the second step of the PRISMA systematic literature review, the screening of the abstracts occurred. In this phase, 10 papers were eliminated from further analysis and consideration. 13 papers entered the eligibility phase, which is third step of the process. This phase includes an in-detail manual screening of both abstracts and full-text papers, which eventually led to a total of 7 (seven) papers that qualified for this literature review. These 7 papers revolve around the use and application of AI and AI-based technologies in green insurance and sustainable insurance. In the next section, a detailed overview of these papers and their findings is provided.

*Figure following on the next page*

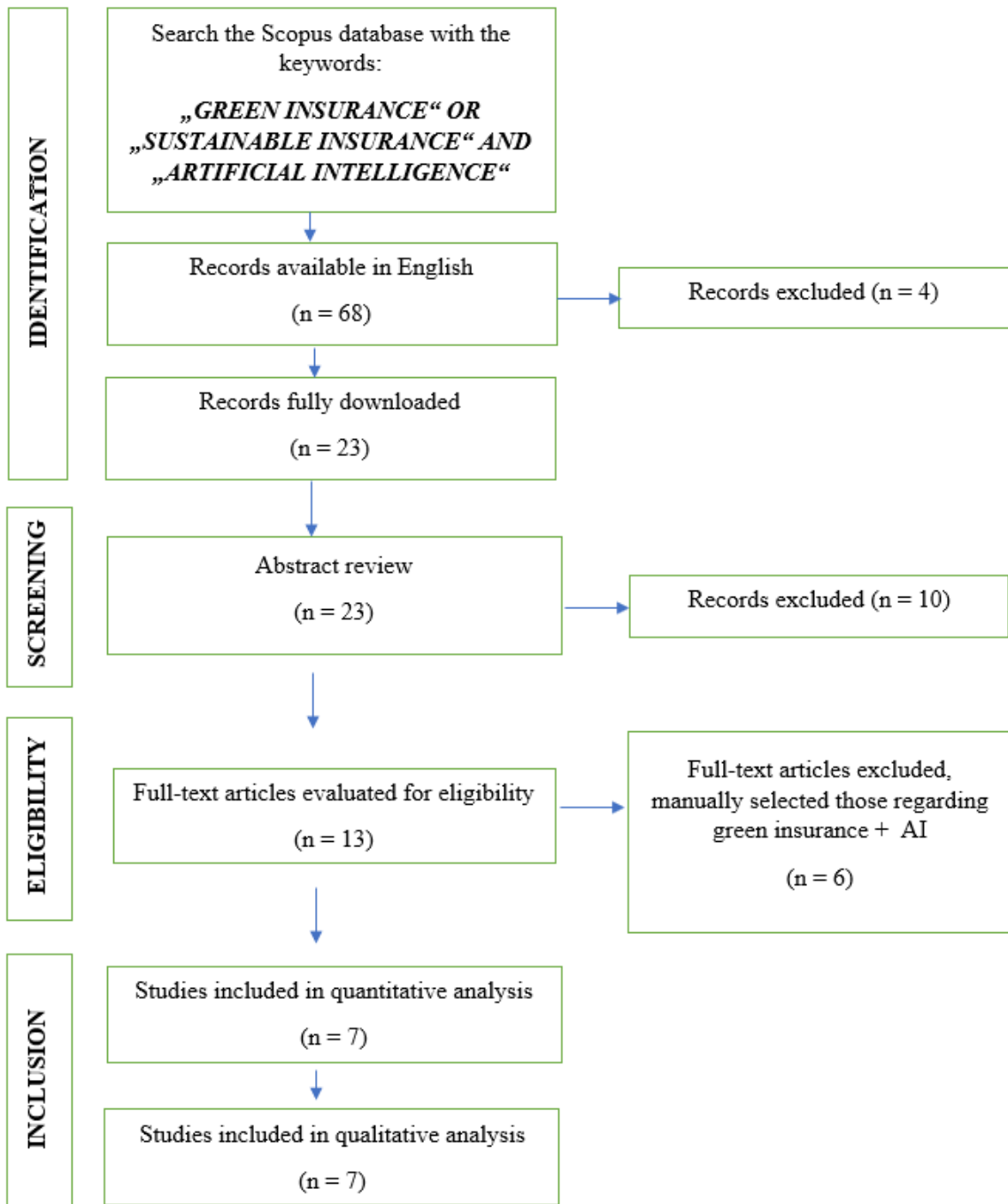

Figure 1: Prisma flow diagram showing article selection process.  
(Source: Authors' work)

#### 4. RESEARCH RESULTS

The main goal of this systematic literature review was to survey the most relevant scientific database (i.e. the Scopus database) in systemizing the previous relevant published work regarding the application of AI and green/sustainable insurance. The results from the PRISMA-guided research process presented in Figure 1 show that only 7 (seven) studies were included in this review. The surveyed published papers that tackle the research issue at hand are presented in Table 1 and a qualitative analysis and presentation of each one of them and their methods, samples, concepts and findings is provided thereafter.

Authors	Paper title	Type of paper	Published in
<b>Ratnakaram et al. (2020)</b>	Emerging Trends in the Marketing of Financially Engineered Insurance Products	Conference paper	<i>Advances in Intelligent Systems and Computing</i>
<b>Liu et al. (2021)</b>	The sustainable development of financial topic detection and trend prediction by data mining	Article	<i>Sustainability (Switzerland)</i>
<b>Khan et al. (2021)</b>	Development of an intelligent decision support system for attaining sustainable growth within a life insurance company	Article	<i>Mathematics (Switzerland)</i>
<b>Sharma (2023)</b>	Big Data in Finance: A Systematic Literature Review	Conference paper	<i>AIP Conference Proceedings</i>
<b>Jagrič et al. (2023)</b>	New Suptech Tool of the Predictive Generation for Insurance Companies—The Case of the European Market	Article	<i>Information (Switzerland)</i>
<b>Rafiuddin et al. (2023)</b>	Growth evaluation of fintech connectedness with innovative thematic indices – An evidence through wavelet analysis	Article	<i>Journal of Open Innovation: Technology, Market, and Complexity</i>
<b>Tiwari (2023)</b>	Health insurance and humanoid robot-agents: a case study	Article	<i>Asia Pacific Journal of Health Management</i>

Table 1: Surveyed published Scopus papers regarding green/sustainable insurance and AI. (Source: Authors' work)

**Ratnakaram et al. (2020)** tackle the „second decade (2D) of the current Century (2D/21st Century) revolutionary disruptive technological advancement, innovative strategies, financially engineered models in the marketing of insurance products across the insurance sector worldwide“. Some of these technologies and advancements are named as “FinTech, InsurTech, Blockchain Technology, Cryptocurrency, Robotics, Cloud Technologies, Data Science, Data Analytics, Big Data, Financial Engineering, ICTs (Information and Communication Technology), IoT (Internet of Things), AI (Artificial Intelligence), Machine Learning, Mobile Phones, Social Media sites, and Drown Technologies”. They present the emerging trends in the marketing of insurance products, which are: Artificial Intelligence (AI), Robotic Process Automation (RPA), Machine Learning, Augmented Reality/ Virtual Reality (AR/VR), Big Data Predictive analytics (BDPA), and Blockchain Technology (BCT). The main contribution of this paper is to present and analyse the above-mentioned technologies and Financial Engineering models and their potential use and application in the insurance sector.

**Liu et al. (2021)** dive into the field and intersection of blockchain and finance, as an „interdisciplinary, cross-technology and cross-field topic“, and tried to address certain limitations in both theory and application. In their extensive bibliometric study, they surveyed the Web of Science scientific database and found 759 papers that are related to the blockchain

and AI technologies in the financial sector (i.e. including the insurance sector, among other financial sectors). They found „ten research topics in the field of blockchain combined with finance, including blockchain crowdfunding, Fintech, encryption currency, consensus mechanism, the Internet of Things, digital financial, medical insurance, supply chain finance, intelligent contract and financial innovation“. The main contribution of this study is the formation of „systematic and diversified analysis of the more comprehensive literature data in the financial blockchain field“.

**Khan et al. (2021)** conducted a study of customer satisfaction in a case study example of a life insurance company, and they compared artificial intelligence-based, data-driven approaches to classical market segmentation approaches. They developed an artificial intelligence-based decision support system which helps accurately classify potential life insurance buyers. They proposed a supervised machine learning modelling approach in combination with a logistic regression model-based decision support systems to conduct advanced consumer behaviour and thus, identified „the cluster of potential buyers with collective accuracies of 98.82% and 89.20%, respectively“. Their developed model could represent practical implications for insurance companies as help with the decision-making systems. This way, insurance companies could benefit their marketing efforts and costs and could address only those clusters of buyers which are identified by the AI-based system.

**Sharma (2023)** conducted a comprehensive literature review on the topic of “Big Data in finance”. The study systematizes the papers according to the year of publication, authors, affiliation, keywords, source and citations and they explore and survey the Scopus database. The main contribution of this study is that it tackles and provides insights into the „trends and future scope of big data in finance“. The „artificial intelligence, credit-rating, financial reporting financial crisis, stock trading, assets-pricing, portfolio optimization, banking & insurance and auditing“ are identified as sub-sets of big data in finance. Moreover, he claims that fields like cryptocurrency, green finance, sustainability, and financial accessibility are the future trends that need to be monitored and expected shortly.

**Jagrič et al. (2023)** propose a new supotech (AI) tool for predictive generation for insurance companies by employing Kohonen’s self-organizing maps. In their study, they include 4058 observations from the European insurance market in the period from 2012 to 2021. Interestingly, their model is novel and does not rely on traditional methodologies and searches for similarities in insurers’ financial behaviours. This way, a common characteristic for different European insurance companies was identified, which can help with prognosis and later on discover their potential future financial worsening or collapse. The main contribution of their novel approach is that this Supotech AI tool can „support early detection of the possible future financial distress of an insurance company“.

**Rafiuddin et al. (2023)** measure the growth of Fintech „in terms of size, participants, user market growth, and the role of stakeholders and policymakers“ and its contribution to the sustainable development goals introduced by the United Nations. For this purpose, they employed the wavelet coherence method (on FintechIndex with the MSCI benchmarks for investment portfolio purposes) to analyze the connection in the stock market co-movements. This is a novel and original study since they include „Artificial Intelligence & Big Data Index (IAIQ), Blockchain Index (ILEGR), Disruptive Technology Index (IDTEC), Global Fintech Index (IFINIX)“. Their findings reveal that Fintech investments have proven to acquire large amounts of capitalization.



*Tiwari (2023)* focused on health risks as one of the main challenges for emerging and developing countries. Moreover, he tackles the potential help AI-based technologies and Machine Learning could provide to these challenges but addresses the needed behavioral challenges in the adoption of AI in insurance. With a case study approach, he explores the above-stated challenges by studying „people’s attitude towards humanoid agents“, i.e. he employed the technology diffusion theory in an attempt to understand how people would react and perceive a hypothetical scenario in which insurance companies use humanoid agents to minimize the information gap in the health insurance domain, replacing traditional agents. Finally, he found that the lack of emotional traits such as „empathy, kindness and emotional intelligence limit the feasibility of robot agents in the health insurance domain“.

## **5. DISCUSSION AND CONCLUSION**

In this paper, the main aim was to explore and identify the relevant scientific papers that revolved around green and sustainable insurance and the use of AI-based technology and tools. The PRISMA-guided systematic literature review presented seven relevant papers that were indexed in the Scopus scientific database. Therefore, the inevitable trends in this research area are revealed. Most of these seven surveyed relevant papers were published in 2023 (four of them), two of them were published in 2021, and one paper was published in 2020 (as shown in Figure 2). The first paper written on this subject was published in 2020 (Ratnakaram et al., 2020), which reveals that this is a very topical subject that is currently evolving and trending, i.e. AI tools are currently being developed and introduced in the insurance industry. Most of these papers tackle new AI tools to be used in the insurance sector. For instance, Tiwari (2023) used a case study approach to introduce humanoid (AI-based) agents, instead of traditional agents, to minimize the information gap in the health insurance domain. Jagrič et al. (2023) proposed a new supotech (AI) tool of predictive generation for insurance companies that could help in the early detection of the potential future financial distress of an insurance company. Rafiuddin et al. (2023) measure the growth of Fintech in terms of the stock market and encompass Artificial Intelligence & Big Data Index (IAIQ), Blockchain Index (ILEGR), Disruptive Technology Index (IDTEC), Global Fintech Index (IFINIX). Ratnakaram et al. (2020) presented the emerging trends and AI tools used in the marketing of insurance products, which are: Artificial Intelligence (AI), Robotic Process Automation (RPA), Machine Learning, Augmented Reality/ Virtual Reality (AR/VR), Big Data Predictive analytics (BDPA), and Blockchain Technology (BCT), thus inspiring and educating other insurance companies’ management. Sharma (2023) found that „artificial intelligence, credit-rating, financial reporting financial crisis, stock trading, assets-pricing, portfolio optimization, banking & insurance and auditing“ are sub-sets of big data in finance. Moreover, fields like cryptocurrency, machine learning, entrepreneurial finance, green finance, sustainability and sustainability practices, and financial accessibility are identified as the future booming trends and areas that need to be monitored and expected soon.

*Figure following on the next page*

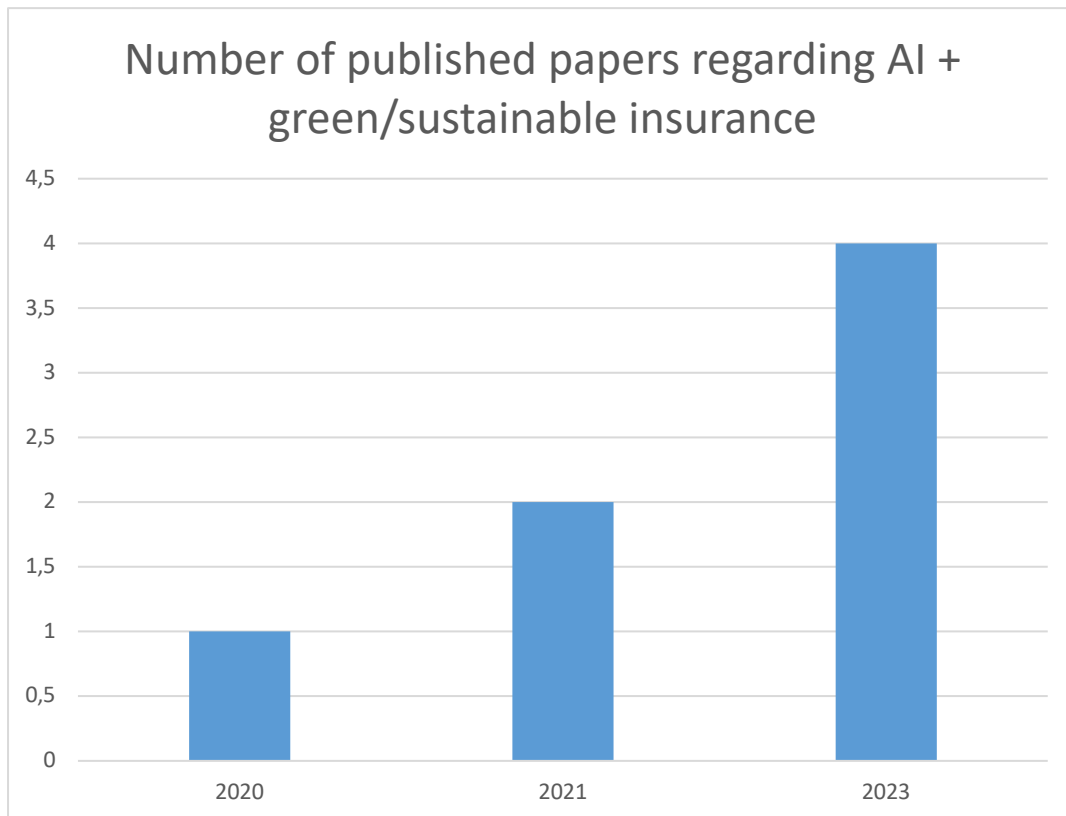

Figure 2: Number of published papers per year.  
(Source: Authors' work)

This study revolves around a very important issue that needs to be looked into. This study represents the first step in this direction and is among the very few that tackle the intersection between green/sustainable insurance and the use of AI technology and AI tools. However, this study is not flawless and the authors are aware of its shortcomings. For instance, the main limitation of this study is mirrored in its reliance on only the Scopus scientific database, and its ignorance regarding other globally renowned scientific databases. In future work, these limitations are to be overcome, as the authors plan to employ a more comprehensive systematic literature review encompassing many scientific databases. Moreover, future work is planned to explore the use of AI technology in insurance companies in Croatia.

#### LITERATURE:

1. Jagrič, T., Zdolšek, D., Horvat, R., Kolar, I., Erker, N., Merhar, J., Jagrič, V. (2023). New Suptech Tool of the Predictive Generation for Insurance Companies—The Case of the European Market. *Information*, 14, 565. <https://doi.org/10.3390/info14100565>
2. Khan, M. F., Haider, F., Al-Hmouz, A., & Mursaleen, M. (2021). Development of an intelligent decision support system for attaining sustainable growth within a life insurance company. *Mathematics*, 9(12), 1369.
3. Krišto, J., Žaja, M. M., & Jakšić, S. (2023). How does mutual ownership affect insurance investments?. *Journal of co-operative organization and management*, 11(1), 100191.
4. Liu, Y., Zhang, S., Chen, M., Wu, Y., & Chen, Z. (2021). The sustainable development of financial topic detection and trend prediction by data mining. *Sustainability*, 13(14), 7585.
5. Nogueira, F. G., Lucena, A. F., & Nogueira, R. (2018). Sustainable insurance assessment: Towards an integrative model. *The Geneva Papers on Risk and Insurance-Issues and Practice*, 43, 275-299.

6. Perčević, H. (2023). The impact of investments in financial assets on the financial position and profitability of insurance companies in Croatia. *Zbornik Ekonomskog fakulteta u Zagrebu*, 21(1), 1-18.
7. Pirotta, K., Grima, S., & Özen, E. (2022). Perceived effectiveness of digital transformation and InsurTech use in Malta: a study in the context of the European Union's Green Deal. In: *Big Data: A Game Changer for Insurance Industry*, 239–263. doi:10.1108/978-1-80262-605-620221016
8. Rafiuddin, A., Gaytan, J. C. T., Mohnot, R., Sisodia, G. S., & Ahmed, G. (2023). Growth evaluation of fintech connectedness with innovative thematic indices—An evidence through wavelet analysis. *Journal of Open Innovation: Technology, Market, and Complexity*, 9(2), 100023.
9. Ratnakaram, S., Chakravaram, V., Vihari, N. S., & Vidyasagar Rao, G. (2021). Emerging trends in the marketing of financially engineered insurance products. *ICT Systems and Sustainability: Proceedings of ICT4SD 2020, Volume 1*, 675-684.
10. Scordis, N. A., Suzawa, Y., Zwick, A., & Ruckner, L. (2014). Principles for sustainable insurance: Risk management and value. *Risk Management and Insurance Review*, 17(2), 265-276.
11. Sharma, S. (2023). Big data in finance: A systematic literature review. *AIP Conf. Proc.* 28 November 2023; 2909 (1): 030010. <https://doi.org/10.1063/5.0182378>
12. Stricker, L., Pugnetti, C., Wagner, J., & Zeier Röschmann, A. (2022). Green insurance: A roadmap for executive management. *Journal of Risk and Financial Management*, 15(5), 221.
13. Subramanian, V., Semenzin, E., Hristozov, D., Zabeo, A., Malsch, I., McAlea, E., ... & Marcomini, A. (2016). Sustainable nanotechnology decision support system: bridging risk management, sustainable innovation and risk governance. *Journal of Nanoparticle Research*, 18, 1-13.
14. Tiwari, A. (2023). Health insurance and humanoid robot-agents: A case study. *Asia Pacific Journal of Health Management*, 18(1), 224-233.
15. United Nations. (2015). *The 2030 Agenda for Sustainable Development*. Technical Report. Geneva: United Nations, Department of Economic and Social Affairs, Sustainable Development. Available online: <https://sdgs.un.org/goals> (accessed on 16 May 2023)
16. Akinsola, J. E. T., Adeagbo, M. A., Oladapo, K. A., Akinsehinde, S. A., & Onipede, F. O. (2022). Artificial intelligence emergence in disruptive technology. In *Computational intelligence and data sciences* (pp. 63-90). CRC Press.
17. Bennett, M. (2021). Compression, the Fermi paradox and artificial super-intelligence, in: *Artificial General Intelligence*. <https://api.semanticscholar.org/CorpusID: 238353964>. (Accessed 25 February 2024).
18. Garrett, M. A. (2024). Is artificial intelligence the great filter that makes advanced technical civilisations rare in the universe?. *Acta Astronautica*, 219, 731-735.

## **SUSTAINABILITY PERFORMANCE ASSESSMENT OF ACCOMMODATION FACILITIES IN ARMAÇÃO DOS BÚZIOS, RJ (BRAZIL): A CASE STUDY IN LIGHT OF THE ESG CRITERIA LISTED IN ABNT PR 2030:2022**

**Jaqueline Kropf Esteves de Matos**

*Universidade Federal Fluminense (UFF), Niterói, Brazil  
jkematos@id.uff.br*

**Marcelo Miguel da Cruz**

*Universidade Federal Fluminense (UFF), Niterói, Brazil  
cruzmarcelo@id.uff.br*

**Sergio Ricardo da Silveira Barros**

*Universidade Federal Fluminense (UFF), Niterói, Brazil  
sergiobarros@id.uff.br*

**Luis Alberto Duncan Rangel**

*Universidade Federal Fluminense (UFF), Niterói, Brazil  
luisduncan@id.uff.br*

**Gilson Brito Alves Lima**

*Universidade Federal Fluminense (UFF), Niterói, Brazil  
glima@id.uff.br*

### **ABSTRACT**

*As 2030 approaches, the deadline for implementing the United Nations' 17 Sustainable Development Goals (SDGs), and the concern about sustainability increases globally. Organizations and countries are still far from achieving the goals set by the SDGs. Tourism, an important sector for global socioeconomic development, impacts and is impacted by different stakeholders, and can preserve and affect the environment and society. Given the importance of Armação dos Búzios, RJ, Brazil, as a tourist destination internationally recognized for its natural beauty and rich cultural heritage, the analysis of sustainability practices adopted by local accommodation facilities is extremely important to avoid the stagnation of the destination, allowing the place to continue attracting national and international tourists. Considering these aspects, this study aims to quantitatively measure the sustainable performance of accommodation facilities in Armação dos Búzios in light of the ESG (environmental, social and governance) criteria described in ABNT PR 2030:2022 (Associação Brasileira de Normas Técnicas – Prática Recomendada). To this end, a survey was carried out, based on data and information displayed on the websites of accommodation facilities located in the municipality. The results revealed the performance of the municipality and the accommodation facilities in relation to the ESG criteria of ABNT PR 2030:2022 and point out a gap by showing that, despite adopting some sustainable practices, the city's accommodation facilities are still far from a more significant performance. In terms of percentage values: five accommodation facilities stood out within the sample analyzed throughout the research, precisely because they are aligned with ESG practices based on ABNT PR 2030:2022 and for adequately publicizing their sustainability initiatives on their websites.*

**Keywords:** *Accommodation facilities, Armação dos Búzios, RJ, Brazil, ESG, Sustainability, ABNT PR 2030:2022*

## 1. INTRODUCTION

Wrongly characterized as a “clean industry”, the hotel industry also impacts the environment and the community in which it operates, as corroborated by Schenini *et al.* (2005): “Hotels also use natural resources and, by using them, cause their reduction, representing a significant environmental, economic and social impact”, such as the economic exploitation practiced against tourists, the omission of instructions for visitors, disrespect to local culture, and the permission to use hotel facilities for the practice of sexual exploitation of children (Miranda, 2007). According to Oliveira & Rossetto (2014), despite some timid (but effective) initiatives by a few accommodation facilities regarding the adoption of sustainable practices, managers do not see advantages in the short and medium term and/or do not have the financial resources for this investment. The authors point out the high costs due to investments in operational adaptation, lack of time and knowledge, risks in customer satisfaction, difficulty in involving workers and the belief that hotels do not generate environmental impacts as the main obstacles to implementing socio-environmental practices in the hotel industry. As tourism is an economic activity whose main inputs are natural and cultural heritage, its direct interest is in sustainable development (Dorsa, 2022). Combined with this fact, if planned in a sustainable way, tourist activity can also be a great instrument for protecting the environment and transforming society, for example through minimizing environmental impacts in all accommodation practices, conservation of natural areas, flora and fauna, minimization of impacts on construction and architecture, management of solid waste, effluents and emissions, energy efficiency, conservation and management of water use, among others (Associação Brasileira de Normas Técnicas - ABNT, 2014). For this reason, Brazil has created different strategies to promote the sustainable development of the sector. For example, in the Plano Nacional de Turismo (2018-2022), one of the proposed guidelines is to promote the sustainability of destinations and one of its lines of action encourages responsible tourism by stimulating the adoption of sustainable practices in the sector (Brasil, 2023). With approximately 40 thousand inhabitants, Armação dos Búzios, located in the state of Rio de Janeiro, attracts more than 600 thousand tourists per year. As a consequence, its main economic activity is tourism: 10.35% of the municipality's commercial establishments are directly linked to tourist activity (hotels or tourism agencies) and another 17.8% are in the food and beverage sector (SEBRAE, 2023), ranking 5th as an international destination in the country. Its main tourist segments are Sun and Beach Tourism, Nautical Tourism and Sports Tourism, categories that are directly dependent on a preserved environment. However, according to Barbosa (2003), the development of this sector was accompanied by disorderly urban occupation, intensified over the last three decades, which generated numerous social and environmental losses. This situation is accentuated during the high season, compromising the well-being of the local population and tourists. The “Sustainable Travel Report” survey released by Booking.com in February 2023 interviewed more than 33 thousand consumers from 35 countries. The results of this survey revealed that 80% of respondents confirm that traveling sustainably is important; 53% say recent news about climate change has influenced them to make more sustainable travel choices and 76% say they want to travel more sustainably in the next 12 months. On the contrary, only 11% claim to consume products and services exclusively from brands that promote sustainability. Along these lines, Leite *et al.* (2018) confirm that it is in this context of adaptations that the environmental discussion is inserted into accommodation facilities through sustainable practices, recognizing that sustainability issues have gained competitive value for guests over concerns about high value and comfort. Taking into account the quality of services, the maintenance of the economic sustainability of the business, the preservation of environmental and socio-cultural aspects, some government incentives and the increase in popular demand regarding sustainability issues, some entrepreneurs in the hotel sector decided to invest in good practices, aiming to enhance value and provide a competitive advantage to their business.

Although still initial, managers have sought to constantly improve their services, frequently adapting to satisfy their guests (Leite *et al.*, 2018). There is a gradual increase in the understanding of entrepreneurs that, for the business to survive in the long term, immediate actions are necessary. This concern is due to the greater competitiveness of the Brazilian market. A trend that has already been happening is that quality is no longer a source of competitive advantage, but rather a basic requirement. Therefore, it is necessary to add intangible values to the provision of services. And it is in this aspect that sustainable management can make all the difference. As a modern approach to the ideas of sustainability, the concept of ESG (environmental, social and governance) emerged at the beginning of the 21st century among all kinds of companies. Additionally, a growing body of research underscores the importance of ESG practices in the hotel industry. Chung (2023) and Muhomorova (2021) both highlight the potential for ESG to enhance operational efficiency and attract investors and employees. This is further supported by Park (2023), who found that hotel guests are willing to accept additional costs for ESG management, indicating a positive perception of its importance. These studies collectively suggest that ESG practices can not only improve operational efficiency and attract stakeholders, but also enhance consumer perceptions and loyalty in the hotel industry. Thus, this research aims to quantitatively measure the sustainable performance of accommodation facilities in Armação dos Búzios, Brazil using the ESG criteria from ABNT PR 2030:2022 (Associação Brasileira de Normas Técnicas – Prática Recomendada). Its importance lies in developing a novel performance assessment for these facilities, crucial for one of Brazil's main tourism destinations. The remaining topics in this article are structured as follows. Section 2 details the theoretical topics that underpin the research theme. Section 3 describes the methodological approach adopted. Section 4 presents the application and results obtained, detailing them regarding each of the axes. Finally, section 5 describes the conclusions and suggests some opportunities for future research.

## **2. THEORETICAL BACKGROUND**

### **2.1. The interdisciplinary perspective of sustainability and the ESG approach**

Sustainability can be defined as the characteristic of a process or system that allows it to exist for a certain time or indefinitely (Mecca *et al.*, 2023). Bodnar *et al.* (2016) state that understanding sustainability requires in-depth cognitive exploration, not only due to its rich historical evolution, but also because of its diverse dimensions and manifestations in a wide range of areas of knowledge. Therefore, it is essential to understand sustainability from an interdisciplinary perspective. In this context, the term sustainability began to be used to define a results management approach balanced between three pillars: economic, social and environmental, also widely known as Tripple Bottom Line (ABNT, 2022). It is important to realize that, when approaching sustainability and its tripod, it cannot be understood that they happen in isolation (Mecca *et al.*, 2023). That is, sustainability, referring to the ability to maintain practices in the long term, encompasses a broad concept that dates back to concerns about the effects of human activities on the environment in periods earlier than commonly imagined. The term, coined in the Brundtland Report (Our Common Future) in the 1980s, has become a principle according to which the use of natural resources to satisfy present needs should not compromise the satisfaction of the needs of future generations. However, human interference in natural environments has been promoting some negative impacts, requiring their minimization/mitigation. Such impacts have motivated the discussion on how to reconcile economic development while minimizing the environmental impacts generated, and how to promote greater inclusion and generation of social value (ABNT, 2022). In this sense, in 2015, the United Nations (UN) proposed to its member countries a new sustainable development agenda for the subsequent 15 years, the 2030 Agenda, composed of the 17 Sustainable Development Goals (SDGs), considered as guidelines that are used to support everything from

business decisions to public actions/policies. Thus, for ABNT (2022), the application of sustainability concepts and practices by different agents in society, such as private and public organizations, associations, among others, promotes and enables sustainable development as a broader result for society, countries and the planet. Consequently, the concept of sustainability evolves and expands, including corporate governance as yet another concern for companies. The concept of ESG then arises, as we will see in the following section.

## **2.2. ESG (Environmental, Social and Governance)**

The term ESG originated from the concept of SRI (Socially Responsible Investing), which dates back to the 1960s-1970s (Cruz *et al.*, 2022). During this period, both Europe and the United States, the main economic regions of the time, were facing various problems primarily caused by World War II. However, in the post-war period and facing a significantly deteriorated global economic scenario, some interventions were necessary in order to try to rebuild the world economy. With this, the opportunity arose for a more sustainable restart, guiding government investments in initiatives and actions with long-term effects. According to Gao *et al.* (2021), the term ESG “environmental, social and corporate governance” appears for the first time in a report entitled “Who Cares Wins”, in 2004. This report, published by the UN, aimed to contribute to the construction of a better way to integrate environmental, social and governance issues into company asset management, offering a way to improve organizational performance. Since the creation of the idea of sustainable development, sustainable practices and investments in the corporate world have been promoted through various initiatives, in response to the growing awareness of environmental and social issues and the need to create a balance between economic growth and environmental protection. Thus, from the first decade of the 21st century and already influenced and motivated by sustainability ideas, managers began to recognize the importance of adopting sustainable and responsible practices to promote a competitive advantage and gain the trust of investors. The ESG movement gained even more strength in 2006, when the UN, together with large institutional investors (pension and investment funds), launched the Principles for Responsible Investment (PRI) (ABNT, 2022), which serves as a basis for investment analysis and decision making by managers. According to Gillan *et al.* (2021), despite not being unanimous, many studies try to find the relationship between ESG performance and financial performance, and one of the most discussed questions in ESG literature is whether management decisions regarding corporate responsibility affect performance and value of companies. However, for these companies to be positively affected, it is necessary to adjust their ways of reporting and publishing their ESG practices, regardless of the tool and/or means of disclosure adopted. In other words, both investors and clients need to know about the company’s good ESG practices so that some value is perceived by the organization. This arises from the need for adaptation of the world population to meet broader circumstances (problems), as well as the set of variables directly or indirectly involved, which can be altered through changes in the habits of human beings themselves. After all, sustainability is an ideal, something to be incessantly sought and developed, jointly and collaboratively. In other words, absorbing ESG practices into organizations' business strategies, even though it is a path under construction, has already become a reality of no return (ABNT, 2022).

## **2.3. Aspects of the hotel industry in the context of sustainable tourism**

The tourism sector, since the beginning of the 20th century, has been considered an economically relevant activity (Dinis & Breda, 2021), with great importance/weight in the GDP of some regions of the world. Its potential in shaping a better world has led to its rise as one of the most crucial socioeconomic sectors today.

It is considered a sector of great importance in the national and international socioeconomic scenario due to its great potential to contribute to the generation of employment and income and its significant participation in the Gross Domestic Product (GDP) (Paula *et al.*, 2020). Tourism seeks to address economic, social and environmental aspects and has governance as a great ally to the development of tourist destinations and their actors (commerce, services, attractions, among others) (Mecca *et al.*, 2023). The sustainable aspect of tourism has considered cultural authenticity, social inclusion, environmental conservation and quality of services as fundamental elements for economic viability over a long period of time (Miranda, 2007). During the Rio+20 conference in 2012, world leaders committed to supporting sustainable tourism initiatives, aiming for the sustainable growth of developing nations. This action encouraged the creation of microcredits to promote sustainable tourism certification for small and medium-sized companies. Since then, the development of indicators to measure sustainable tourism and assist in the decision-making process of tourist destination managers has been a constant concern for some international organizations (Dinis & Breda, 2021). The launch of the UN Global Compact in 2015 led the UNWTO to defend tourism as an important ally in achieving sustainability and created an online platform with the aim of promoting the adoption of the SDGs across the sector. Thus, in parallel with its local economic relevance, tourism can also contribute, directly or indirectly, to all of the UN SDGs – with emphasis on SDGs 8, 12 and 14; which are related, respectively, to inclusive and sustainable economic growth, sustainable consumption and production and the sustainable use of the oceans and marine resources. The growing commitment of the global community is evident, with many countries recognizing the possibility of transforming tourism into the foundation of development. With this, the UN defined the year 2017 as the International Year of Sustainable Tourism, emphasizing the importance of tourism as a path to supporting the SDGs. In 2018, the UNWTO (World Tourism Organization) began developing the Statistical Framework for Measuring Tourism Sustainability (SF-MST), a framework for integrating statistics on the economic, environmental and social dimensions of sustainable tourism. Its final version was launched in March, 2024. Also prepared by the UNWTO, the ESG Framework for Tourism Businesses is under construction. The Framework responds to the sector's need for a unique ESG reference, the search for a personalized approach to ESG issues within the sector, and the general imperative for companies to actively engage with sustainability-related issues in the face of increasing global pressures and challenges. The Framework will allow for greater comparability between national and subnational levels, destinations and the private sector, providing a unique response to the sector's sustainability needs.

#### **2.4. Context of the hotel industry and accommodation facilities**

The hotel industry is an important branch of the tourism sector, because for travel activities to be carried out, in addition to transportation, there must be a place for accommodation, thus making accommodation facilities essential for the growth of tourism (Matos & Costa, 2014). When addressing the social issue in the hotel industry, it is important to emphasize that all stakeholders must be involved, both internal (directly related to the enterprise's activities) and external, that is, suppliers, guests and surrounding communities (Miranda, 2007). In the environmental sphere, according to Matos & Costa (2014), among the main environmental impacts caused by the hotel industry are: the depletion of natural resources, water and energy consumption, changes in water quality, untreated sewage effluents, the increase in the amount of garbage and air pollution, due to the emission of gases into the atmosphere. Hotels are one of the means of accommodation, being one of the main economic agents of tourism in a location or region (Schenini *et al.*, 2005). Therefore, there is no way to think about tourist activity without planning the hotel infrastructure (Matos & Costa, 2014), especially when aiming at achieving the much-desired sustainable development.



Therefore, in the hotel industry, the adoption of sustainable productivity measures considers the need to control productive activities in order to minimize negative impacts on the environment and the surrounding community (Miranda, 2007).

### **3. METHODOLOGICAL APPROACH**

#### **3.1. Search ranking**

It is known that each and every classification is made using some criteria (Gil, 2002). Therefore, this research is classified, in terms of its nature and objectives, as an applied, exploratory and descriptive research, respectively. Regarding its approach, this study can be described as combined research (qualitative and quantitative). Regarding research procedures (data collection and analysis), data collection was used (via the Cadastur database) to obtain information about the registered institutions, as well as case study procedures for the design of this research. In general, case studies represent the preferred strategy when questions such as "how" and "why" are asked, when the researcher has little control over events and when the focus is on contemporary phenomena within some context of real life (Yin, 2015).

#### **3.2. Data collection**

The most important element for identifying a design is the procedure adopted for data collection (Gil, 2002). Thus, in the present study, after carrying out the theoretical basis, through consulting papers, books and other kinds of academic works, a data collection was carried out in the Cadastur database (available at: <https://cadastur.turismo.gov.br/hotsite/#!/public/sou-turista/inicio>), seeking to identify tourist service providers registered as accommodation facilities in the city of Armação dos Búzios. The consultation was carried out on 09/19/2023 and the data was transferred to an electronic spreadsheet, in order to consolidate them. In this consultation, 246 service providers (accommodation facilities) were identified, which had the following data extracted: CNPJ, name, electronic address (website), email address and telephone number.

#### **3.3. Data analysis**

During the data analysis stage, a verification was carried out regarding the suitability of service providers (accommodation facilities) considering the themes and criteria present in ABNT PR 2030 for each of the ESG axes (environmental, social and governance). However, as a source for carrying out this analysis, the websites (pages) of the service providers themselves, registered in the Cadastur database, were considered. Nevertheless, in cases where the service provider had not provided their email address, searches were carried out (active search) via Google, in an attempt to find an official website for these service providers, complementing the information available in the electronic spreadsheet. Therefore, the possibility of analyzing them through their social networks (e.g. Facebook, Instagram, etc.) was ruled out, considering that these means would not provide enough information for analysis, as an official website does. Thus, after consolidating data from the 246 service providers, categorized as accommodation facilities, their official websites were verified, aiming at identifying which topics and criteria were covered by these providers, evaluating their respective level of service (evaluation scale x score), using the scale described in Table 1. Such scale was arbitrated by the authors, with the purpose of quantitatively measuring the performance obtained by each service provider, given the criteria analyzed.

*Table following on the next page*

Rating scale	Description	Score
Yes	Service provider fully presented at least one example and/or evidence of practice related to the theme/criterion evaluated.	1.00
Partially	Service provider partially or incompletely presented an example and/or evidence of practice related to the theme/criterion evaluated.	0.50
No	Service provider did not present any example and/or evidence of practice related to the theme/criteria evaluated.	0.00

*Table 1: Scale used to evaluate ESG themes and criteria*

*Source: Authors*

Through this same table (Table 1), service providers had their scores assigned, establishing a ranking intending to identify which service provider would have the highest number of ESG criteria met, in addition to defining their total score. However, only accommodation facilities that had their websites up and running were evaluated, but the others still make up the final sample of 246 service providers – for information purposes: 98 service providers from the initial sample were removed from the analysis, since only 148 service providers in the final sample had active websites at the time of the research (the only ones with websites available).

## 4. APPLICATION AND RESULTS

### 4.1. Characterization of the City under Study

The city under study, Armação dos Búzios, is located in the Lagos Region, also classified as the Costa do Sol Region, in the State of Rio de Janeiro. The municipality is approximately 176 km away from the capital of Rio de Janeiro, bordering the municipality of Cabo Frio/RJ, from which it was emancipated in 1995. According to data from the Instituto Brasileiro de Geografia e Estatística (2023), considering the 2022 Demographic Census, the municipality has a population of 40,006 inhabitants, distributed over a territorial area of 70,977 km<sup>2</sup> - resulting in a demographic density of the order of 563.65 inhabitants. /km<sup>2</sup>. The city of Armação dos Búzios is considered a Tourist Resort, which combines the charm of a fishing village with the infrastructure of an international resort (Guia do Turismo Brasil, 2023). It was considered the “Brazilian Saint-Tropez”, fame obtained due to its natural beauty and the frequent appearances of French actress Brigitte Bardot throughout the 1960s, taking refuge from the European paparazzi. Thus, from the 1970s onwards, driven by global visibility, its population grew uncontrollably, rising from 4,108 inhabitants (in 1970) to the current 40,006 inhabitants, with migration being the main factor in population growth (Barbosa, 2003). With a vast natural tourist potential, the municipality of Armação dos Búzios is also known for its beautiful beaches, made up of rocky points and shores with dense native vegetation, factors that favor tourist exploration of the place, mainly adventure tourism and ecotourism. During the high season, between December and March, the city's population multiplies, receiving at least 150,000 visitors throughout this period (Barbosa, 2003), becoming one of the main tourist destinations in Brazil. Such importance/prominence also brings certain burdens to the municipality, in social and environmental terms, which according to Barbosa (2003), are accentuated during this period of high season, compromising both the well-being of the local population and the tourists themselves. However, in terms of GDP (Gross Domestic Product), the tourism sector contributes to a good deal of the local economy, being characterized as one of the main economic activities in the municipality, even employing a large part of the population. Given the environmental influence resulting from this economic activity and the socioeconomic relevance of the municipality in the tourism sector at local, regional, state and national levels, there is an interest in examining the sustainability of accommodation establishments located in the region.

#### 4.2. Assessment through the environmental axis (E)

According to ABNT (2022), the environmental axis addresses the negative and positive impacts of organizations on the environment, considering potential or real changes with direct or indirect physical, chemical and biological changes in the environment. Given the knowledge presented and the scale adopted (see previous topics), the performance of the environmental axis for the city as a whole was analyzed first, considering all accommodation facilities with active sites registered in Cadastur, as shown in Table 2.

Code / Theme (TE)		Code / Criteria (CE)		Result
TE01	Climate change	CE01	Mitigation of greenhouse gas emissions (GHG)	2,50
		CE02	Adaptation to climate change	0,00
		CE03	Energy efficiency	12,00
TE02	Water resources	CE04	Water use	4,50
		CE05	Effluent management	1,50
TE03	Biodiversity and ecosystem services	CE06	Conservation and sustainable use of biodiversity	3,50
		CE07	Sustainable land use	1,50
TE04	Circular economy and waste management	CE08	Circular economy	2,50
		CE09	Waste management	5,00
TE05	Environmental management and pollution prevention	CE10	Environmental management	1,00
		CE11	Prevention of noise pollution (noise and vibrations)	11,50
		CE12	Air quality (pollutant emissions)	0,50
		CE13	Contaminated area management	0,00
		CE14	Dangerous products	1,50

Table 2: Environmental axis results

Source: Authors

Thus, the city of Armação dos Búzios obtained a score of 47.50 points (within the limit of 3,444 points = 14 x 246), which is equivalent to a percentage of 1.37921% of global performance for this axis. Graph 1, below, illustrates the distribution of the total score obtained in each of the criteria analyzed in this axis.

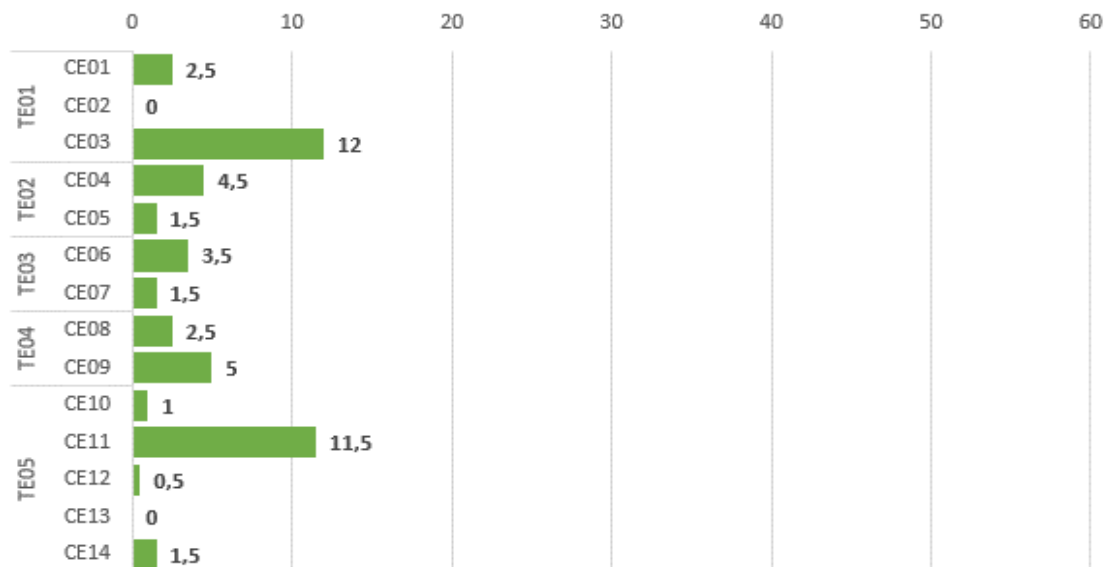

Graph 1: Total score for the environmental axis criteria

(Source: Authors)

In addition to scoring, a complementary analysis was conducted to identify the good and bad practices adopted by accommodation facilities, as well as other elements that could add value to the service provided to customers (tourists). See Table 03 below.

<b>Good practices identified</b>
I - Parking lots with electric car chargers; II - Conscious consumption: use of solar energy panels and adoption of water-saving practices (e.g.: water reuse); III - Practice of donating prizes to the most sustainable guests (those who generate the least waste); IV - Have the “Green Key International” seal (ecological label granted to accommodations with sustainable practices); V - Announcements that speakers are not allowed in the environments (noise pollution); VI - Carrying out environmental actions aimed at: energy efficiency, recycling, reduction of water and paper consumption, conservation of green spaces; however applied in other regions of the world (e.g. Portugal); VII – Seal of recognition for the use of clean energy; VIII - Favoring suppliers who work to sustain, protect and restore the environment through energy conservation, recycling and appropriate waste disposal, as well as environmental restoration.
<b>Bad practices identified</b>
No notes/evidence were found throughout the research.

*Table 3: Good and bad practices identified in the environmental axis*

*Source: Authors*

When separately analyzing the performance of each accommodation option in the environmental context, considering the 14 specific criteria for this domain, the results are shown in Table 4. This table presents the three best accommodation options, filtered based on the percentage obtained in the analyzed axis.

<b>Accommodation facilities</b>	<b>Environmental axis performance (%)</b>
Baía do João Pousada	67,86%
Pousada La Chimère Búzios Essence	35,71%
Pousada Pedra da Laguna	35,71%
Pousada Vila D’Este	28,57%

*Table 4: Top 3 best individual percentage results in the environmental axis*

*Source: Authors*

Thus, given both results found (in local and individual terms), it was observed that accommodation facilities located in the city, especially those listed in Table 4 above, would be more capable of contributing to the reduction of environmental impacts related to: climate change (with emphasis on the use of energy efficiency); water resources (in terms of water use); biodiversity and ecosystem services (in relation to the conservation and sustainable use of biodiversity); circular economy and waste management (focus on waste management); environmental management and pollution prevention (aimed at preventing noise pollution – noise and vibrations). However, the results obtained, especially in local terms, would be below a reasonable value, given the low percentage value (1.37921%) in this axis. This fact could motivate municipal managers to encourage, via public policies, sustainable practices in this specific axis.

### 4.3. Assessment through the social axis (S)

According to ABNT (2022), the social axis addresses the impact on institutions and human relations, respect for fundamental human rights and considers potential or real changes in the surrounding community and workers (for example: health and safety, supply chain, diversity and inclusion). Based on the knowledge exposed and the scale used (as described in the previous topics), the initial analysis focused on the performance of the social component for the city as a whole. This was carried out considering all accommodation facilities with active sites registered in Cadastur, resulting in Table 5.

Code / Theme (TS)		Code / Criteria (CS)		Result
TS01	Social dialogue and territorial development	CS01	Private social investment	0,00
		CS02	Stakeholder dialogue and engagement	1,00
		CS03	Social impact	0,50
TS02	Human rights	CS04	Respect for human rights	0,50
		CS05	Combating forced or compulsory labor	1,00
		CS06	Combating child labor	0,50
TS03	Diversity, equity and inclusion	CS07	Diversity and equity policies and practices	2,50
		CS08	Culture and promotion of inclusion	2,00
TS04	Work relationships and practices	CS09	Professional development	0,00
		CS10	Occupational health and safety	3,50
		CS11	Quality of life	0,50
		CS12	Freedom of association	1,00
		CS13	Remuneration and benefits policy	0,50
TS05	Promotion of social responsibility in the value chain	CS14	Relationship with consumers and clients	53,50
		CS15	Relationship with suppliers	1,50

*Table 5: Social axis results*

*Source: Authors*

Thus, the city of Armação dos Búzios obtained a score of 68.50 points (within the limit of 3,690 points = 15 x 246). This result equates to an overall performance of approximately 1.85637% for this axis. Graph 2, below, shows the distribution of the total score obtained in each of the criteria analyzed in this axis.

*Graph following on the next page*

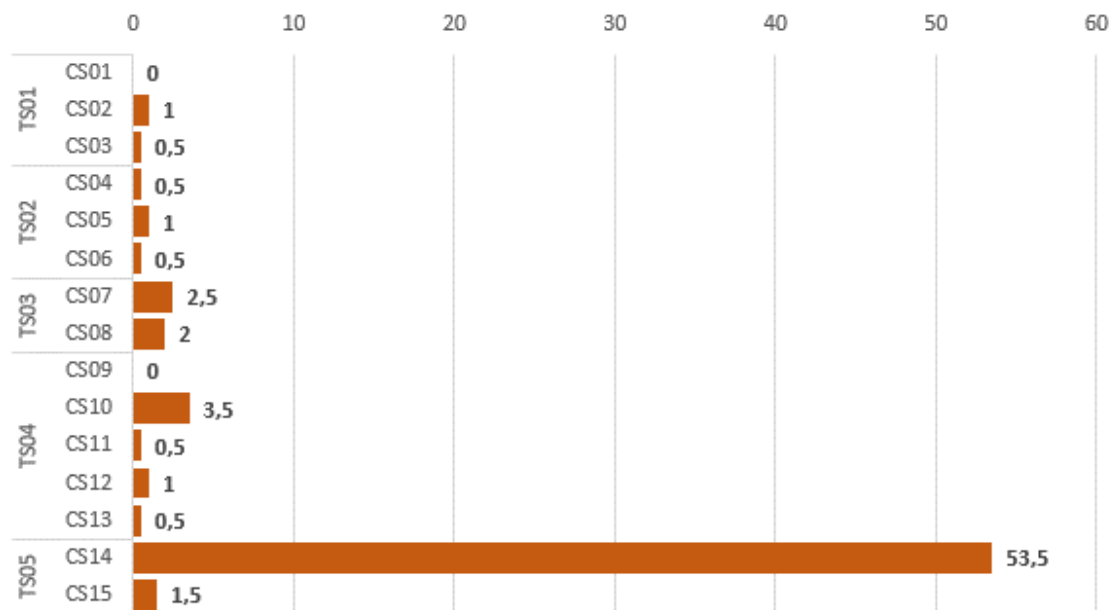

*Graph 2: Total score for the social axis criteria  
(Source: Authors)*

In addition to the score, an additional analysis was conducted to identify positive and negative practices adopted by accommodation facilities, as well as other elements that could add value to the services offered to customers (tourists). This analysis is detailed in Table 6.

Good practices identified
<p>I - Accepting minor children, including promoting discounts for the provision of extra beds or cribs and kids spaces;            II - Accepting pets;            III - Providing parking lots with electric car chargers;            IV - Supporting female entrepreneurship, assist/promote local businesses and services (partnerships with local suppliers);            V - Carrying out social and cultural actions, despite being in other regions (e.g.: Portugal);            VI – Providing accommodation with accessibility features;            VII - Having a contact center/customer service (FAQ's), in addition to the simple contact page;            VIII - Promoting the use of PPE (Personal Protective Equipment) by its employees;            IX - Encouraging its suppliers to promote sustainable practices (supply code of conduct);            X - Establishing policies to combat slave labor.</p>
Bad practices identified
<p>I - Providing websites developed in a single language, different from the native language (e.g. German);            II - Providing contact/evaluation links that are offline (not working or under development);            III - Not accepting accommodation for minors (even in compliance with Article 82 of Law No. 8,069 of July 13, 1990, which authorizes accommodation when they are accompanied by their parents or legal guardian);            IV - Offering risks regarding its facilities (e.g. balconies with risk of falling);            V - Not accepting or charging for hosting pets in their facilities;            VI - Having an infrastructure with accessibility restrictions for guests with mobility problems (wheelchair users or those with limited mobility).</p>

*Table 6: Good and bad practices identified in the social axis  
Source: Authors*

By carrying out an individual analysis of each accommodation option and evaluating its performance on the social axis, which encompasses 15 analysis criteria, the results of this evaluation are presented in Table 7. This table lists the three best accommodation options, selected based on the percentage obtained in the analysis of this specific axis.

Accommodation facilities	Social axis performance (%)
Selina Búzios	46,67%
Pousada Pedra da Laguna	16,67%
Brava Club	10,00%
Brava Club Exclusive	10,00%
Casa Cactus	10,00%
Pousada dos Reis	10,00%
Pousada Miratlântico	10,00%

*Table 7: Top 3 best individual percentage results in the social axis*

*Source: Authors*

Thus, given both results found (in local and individual terms), it was observed that accommodation facilities located in the city, especially those listed in Table 7, would be better able to contribute to the promotion of related social aspects as: social dialogue and territorial development (dialogue and stakeholder engagement); human rights (combating forced or compulsory labor); diversity, equity and inclusion (diversity and equity policies and practices, in addition to culture and promotion of inclusion); work relations and practices (occupational health and safety, in addition to freedom of association); promotion of social responsibility in the value chain (relationships with consumers and clients). However, the results achieved, especially at the local level, demonstrate a performance below what was desired, evidenced by the low percentage value (1.85637%) in this axis. This situation can alert municipal managers about the need to encourage sustainable practices, specifically aimed at this axis, through public policies.

#### **4.4. Assessment through the governance axis (G)**

According to ABNT (2022), the governance axis includes the way in which an organization is governed and makes decisions, considering the corporate governance structures and processes by which organizations are directed and controlled (for example, structure and diversity of the advice, ethical conduct, risk management, disclosure and transparency), including the governance of key environmental and social policies and procedures. Based on the knowledge provided and the previously established scale (as discussed in previous topics), an initial analysis of the performance of the governance axis for the city as a whole was carried out. This analysis took into account all accommodation facilities with active sites registered in Cadastur, resulting in the following outcome, as shown in Table 8.

*Table following on the next page*

Code / Theme (TG)		Code / Criteria (CG)		Result
TG01	Corporate governance	CG01	Structure and composition of corporate governance	0,00
		CG02	Purpose and strategy in relation to sustainability	0,00
TG02	Business conduct	CG03	Compliance, integrity program and anti-corruption practices	0,50
		CG04	Practices to combat unfair competition (antitrust)	0,50
		CG05	Stakeholder engagement	0,50
TG03	Control and management practices	CG06	Business risk management	0,00
		CG07	Internal controls	0,00
		CG08	Internal and external audits	0,50
		CG09	Legal and regulatory environment	0,50
		CG10	Information security management	0,50
		CG11	Personal data privacy	37,00
TG04	Transparency in management	CG12	Accountability (accountability)	0,00
		CG13	ESG, sustainability and/or integrated reporting	0,00

Table 8: Governance axis results  
Source: Authors

Therefore, the city of Armação dos Búzios obtained a score of 40.00 points (within the limit of 3,198 points = 13 x 246), which is equivalent to a percentage of 1.25078% of global performance for this axis. Graph 3 shows the distribution of the total score obtained in each of the criteria analyzed within this axis.

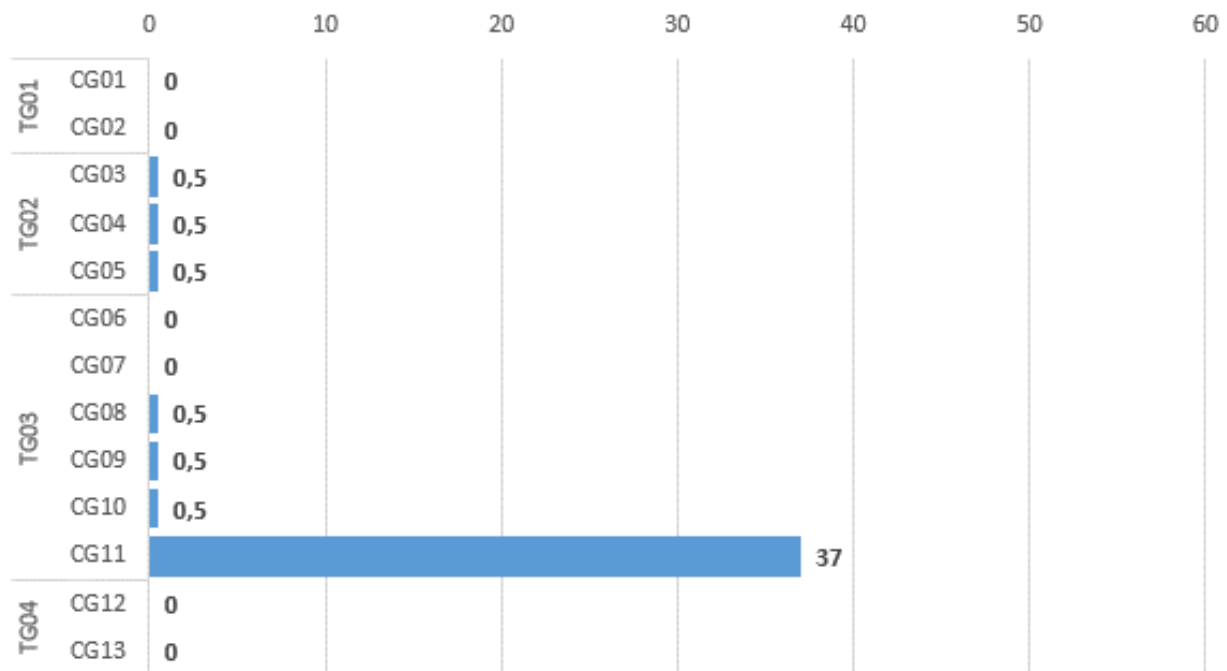

Graph 3: Total score for the governance axis criteria  
Source: Authors



In addition to the scoring evaluation, an additional analysis was conducted to identify both good and less favorable practices adopted by accommodation facilities, as well as other elements that could add value to the services provided to guests. This analysis is detailed in Table 9.

Good practices identified
I - Disclosing links to privacy policies and conditions (processing of personal and browsing data under the LGPD); II - Providing a contact center with employees, in addition to the simple contact page; III - Specifying the manner of handling guests' personal data (consent regarding the use of photos and videos); IV – Disclosure of sustainability reports; V – Establishment of a code of conduct for suppliers.
Bad practices identified
I - Providing a link to a privacy policy that is offline (not working or under development).

*Table 9: Good and bad practices identified in the governance axis*

*Source: Authors*

In individual terms, when each accommodation type is analyzed based on its performance within the governance axis, which has 13 analysis criteria, the result is illustrated in Table 10. This table lists the best accommodation option, selected based on the percentage obtained in the analysis of that specific axis.

Accommodation facilities	Governance axis performance (%)
Selina Búzios	30,77%

*Table 10: Top 1 best individual percentage result in the governance axis*

*Source: Authors*

In addition to the accommodation mentioned in Table 10, another 36 establishments also received scores on this axis. However, all of them presented a relatively lower individual performance, reaching 7.69%. Thus, given both results found (in local and individual terms), it was observed that accommodation facilities located in the city, especially the one listed in Table 10, would be better positioned to contribute to promoting governance factors related to corporate governance, business conduct, control and management practices (focused on personal data privacy), and transparency in management. However, the results obtained, especially in local terms, are considerably below an acceptable level, with a low percentage value (1.25078%) in this axis. This could be a stimulus for organizational managers to adopt sustainable practices specific to this axis, seeking to protect themselves in both legal and ethical terms.

#### 4.5. Synthesis (ESG Performance)

Finally, the result relating to the municipality's performance was consolidated under ESG principles, according to criteria described in ABNT PR 2030:2022 (according to Table 11).

Axes	Performance (%)
Environmental (E)	1,37921% (= 47,50/3.444)
Social (S)	1,85637% (= 68,50/3.690)
Governance (G)	1,25078% (= 40,00/3.198)
<b>ESG Total</b>	<b>1,50987% (= 156/10.332)</b>

*Table 11: Total ESG Performance of the municipality of Armação dos Búzios*

*Source: Authors*

As shown in Table 11, the municipality presented a performance of around 1.51%, a value that exposes the fragility regarding the ideology of sustainable tourism in the municipality. Therefore, the published results can serve as a stimulus for owners of local accommodation facilities to implement new initiatives. Furthermore, they can also influence the creation of public policies aimed at sustainability. This action has the potential to reshape the local tourism sector, directing it towards a path of more sustainable practices. Analogous to the general performance for the municipality, the individual performance of the accommodation facilities was also obtained. However, in order to illustrate only the main accommodation options in the municipality (concerning ESG), that is, only those that reached the highest percentages, Table 12 was prepared, which presents the five best ranked considering the three ESG axes.

Accommodation facilities	ESG performance (%)
Selina Búzios	28,57%
Baía do João Pousada	25,00%
Pousada Pedra da Laguna	20,24%
Pousada La Chimère Buzios Essence	16,67%
Pousada Vila D’Este	11,90%

*Table 12: Top 5 best individual percentage results for ESG*

*Source: Authors*

As shown in Table 12, “Selina Búzios” achieved the best performance among the 246 accommodation facilities, as it declared on its website a significant portion of initiatives in favor of sustainability and ESG. However, it is not isolated in this performance, as other establishments also stood out, forming the group of the five best (Top 5). Although these accommodation facilities have obtained an outstanding result compared to others, their results can be considered low in terms of adherence to their practices in favor of the ideal of sustainability and the implementation of ESG criteria. Therefore, it is up to these and the other accommodation facilities analyzed to assess their suitability, intensifying both the way these principles are applied and the way they are disseminated, if they are interested in contributing to these objectives, being recognized as a local reference.

## 5. CONCLUSION

In the process of adopting sustainable practices, organizations must aim not only to adequately manage their ESG risks and mitigate their negative impacts, but also to take advantage of opportunities to generate positive impacts and create long-term value for a broad set of stakeholders (theory of shared value) (ABNT, 2022). In this sense, organizations must also be engaged in disseminating the good practices adopted by them, as a large part of their clients/consumers may be more critical regarding the adoption of sustainable practices, including weighing their decisions based on some of the criteria related to the topic. Therefore, harmonization between corporate practices aimed at the ESG agenda and the communication strategy is crucial, prioritizing transparency and the presentation of tangible evidence. This must be based on relevant performance indicators, which play a fundamental role in this procedure, ensuring coherence and avoiding misleading disclosure (greenwashing) (ABNT, 2022). Thus, within its initial proposal, the present study identified a gap by showing that, despite adopting some sustainable practices, accommodation facilities in the city of Armação dos Búzios are still far from a more significant performance in terms of percentages. This points to the need of implementing a series of improvement actions, since organizations with better performance in ESG practices are better regarded by society and customers, generating gains in reputation and image (ABNT, 2022).

However, five accommodation facilities stood out within the sample analyzed throughout the research, precisely because they are aligned with ESG practices, under ABNT PR 2030:2022 and for adequately publicizing their sustainability initiatives on their websites. Therefore, considering a more competitive environment in this aspect, where tourists would start to make decisions based on their own sustainability ideals, it is up to the other accommodation options to adapt their operations, in order to generate value and provide a better experience to their customers. Thus, it is concluded that enterprises in the sector (accommodation facilities), located in the municipality of Armação dos Búzios, need to take some actions to improve the local and individual performance of their ESG indicators, disclosing them to their customers as much as possible. Finally, some research suggestions are listed, so as to guide the development of future studies related to this. Here are some suggested alternatives:

- Apply the same research steps (methodology), analyzing other tourist municipalities in the region and/or with the same characteristics or scale;
- Develop a multi-criteria model (e.g.: Fuzzy TOPSIS / MCDM) under the ESG criteria, described in ABNT PR 2030:2022, to assist tourists in making decisions when seeking sustainable accommodation options, based on a group or niche/profile of tourists, specifically;
- Submit a questionnaire to the owners of the accommodation facilities analyzed in this same sample, obtaining information that was not evidenced through the active search carried out on the official websites of their enterprises;
- Propose a performance indicator, on a larger scale, that quantifies the performance of other municipalities and enterprises, promoting a benchmarking (continuous improvement) mentality among them.

**ACKNOWLEDGEMENT:** *This study was financed in part by the Coordenação de Aperfeiçoamento de Pessoal de Nível Superior - Brasil (CAPES) - Finance Code 001. The author Jaqueline Kropf is funded by CAPES grant process number #913063/2023-00. The author Marcelo Cruz is funded by CAPES grant process number #984007/2024-00. The author Gilson B. A. Lima gratefully acknowledges the support from the Brazilian National Council for Scientific and Technological Development - CNPq (PQ grant 311961/2023-1).*

## LITERATURE:

1. Associação Brasileira de Normas Técnicas. (2014). *Norma: ABNT NBR 15401:2014 - Meios de hospedagem - Sistema de gestão da sustentabilidade - Requisitos*. 38.
2. Associação Brasileira de Normas Técnicas. (2022). *Prática Recomendada: ABNT PR 2030:2022 - Ambiental, social e governança (ESG) - Conceitos, diretrizes e modelo de avaliação e direcionamento para organizações*. 135.
3. Barbosa, K. C. (2003). *Turismo em Armação dos Búzios (RJ, Brasil): percepções locais sobre os problemas da cidade e diretrizes prioritárias de apoio à gestão ambiental* [Universidade Federal Fluminense]. [http://www.dadosefatos.turismo.gov.br/export/sites/default/dadosefatos/espaco\\_academico/premio\\_mtur/downloads\\_premio\\_FGV/2turismoemarmacao.pdf](http://www.dadosefatos.turismo.gov.br/export/sites/default/dadosefatos/espaco_academico/premio_mtur/downloads_premio_FGV/2turismoemarmacao.pdf)
4. Bodnar, Z., De Freitas, V. P., & Silva, K. C. (2016). A epistemologia interdisciplinar da sustentabilidade: por uma ecologia integral para a sustentação da casa comum. *Revista Brasileira de Direito*, 12(2), 59–70. <https://doi.org/10.18256/2238-0604/revistadedireito.v12n2p59-70>
5. Booking.com. (2023). *Sustainable Travel Report 2023*. <https://globalnews.booking.com/download/31767dc7-3d6a-4108-9900-ab5d11e0a808/booking.com-sustainable-travel-report2023.pdf>

6. Brasil. (2023). *Plano Nacional de Turismo (PNT) 2018-2022*. <https://www.gov.br/turismo/pt-br/aceso-a-informacao/acoes-e-programas/plano-nacional-do-turismo>
7. Chung, K., Thi, L. and Thi, D. (2023). *Improving Hotels' Operational Efficiency Through ESG Investment: A Risk Management Perspective*. Service science. doi:<https://doi.org/10.1287/serv.2023.0080>.
8. Cruz, M. M. da, Martins, R. A., Assis, F. M. dos S., Cruz, R. G., Póvoas, M. dos S., & Caiado, R. G. G. (2022). Indicadores no contexto ESG (Environmental, Social and Governance): um estudo bibliométrico. *Research, Society and Development*, 11(17), e279111738870. <https://doi.org/10.33448/rsd-v11i17.38870>
9. Dinis, M. G. F., & Breda, Z. (2021). Indicadores de sustentabilidade e a informação estatística do turismo em Portugal. *Revista Rosa Dos Ventos - Turismo e Hospitalidade*, 13(2), 517–537. <https://doi.org/10.18226/21789061.v13i2p517>
10. Dorsa, A. C. (2022). Turismo e desenvolvimento sustentável: janelas para o presente e o futuro. *Interações (Campo Grande)*, 23, 263–266. <https://doi.org/http://dx.doi.org/10.20435/inter.v23i3.3837>
11. Gao, S., Meng, F., Gu, Z., Liu, Z., & Farrukh, M. (2021). Mapping and clustering analysis on environmental, social and governance field a bibliometric analysis using scopus. *Sustainability (Switzerland)*, 13(13). <https://doi.org/10.3390/su13137304>
12. Gil, A. C. (2002). *Como elaborar projetos de pesquisa (Editora Atlas (ed.); 4th ed.)*. Editora Atlas.
13. Gillan, S. L., Koch, A., & Starks, L. T. (2021). Firms and social responsibility: A review of ESG and CSR research in corporate finance. *Journal of Corporate Finance*, 66(June 2020), 101889. <https://doi.org/10.1016/j.jcorpfin.2021.101889>
14. Guia do Turismo Brasil. (2023). *Armação dos Búzios - RJ*. <https://www.guiadoturismobrasil.com/cidade/RJ/746/armacao-dos-buzios>
15. Instituto Brasileiro de Geografia e Estatística. (2023). *IBGE - Instituto Brasileiro de Geografia e Estatística. Cidades e Estados: Armação dos Búzios/RJ*. <https://www.ibge.gov.br/cidades-e-estados/rj/armacao-dos-buzios.html>
16. Leite, A. F. R., Lamas, S. A., & Nóbrega, W. R. D. M. (2018). Sistemas de gestão ambiental e competitividade: uma análise de múltiplos casos em meios de hospedagem de Natal – RN. *Turismo Visão e Ação*, 21(1), 65. <https://doi.org/10.14210/rtva.v21n1.p65-80>
17. Matos, J. K. E. de, & Costa, M. A. N. (2014). Hotelaria, sustentabilidade e certificação: um estudo bibliométrico. *Revista Vértices*, 16(1), 51–75. <https://doi.org/10.5935/1809-2667.20140004>
18. Mecca, M. S., Oliveira, F. M., Witt, A. C. V., & Velho, F. D. (2023). Sustentabilidade e ESG (Environmental, Social and Governance): Estudo das operações turísticas de uma Pousada na Serra Gaúcha. *Turismo: Visão e Ação*, 25(3), 425–444. <https://doi.org/10.14210/rtva.v25n3.p425-444>
19. Miranda, M. C. de A. (2007). *Ecopousada Lençóis - Uma proposta de hotelaria sustentável*. Universidade de Brasília.
20. Muhomorova, I.V. (2021). *ESG transformation and development of hotel business*. Gostinichnoe delo (Hotel Business), (12), pp.62–70. doi:<https://doi.org/10.33920/igt-2-2112-06>.
21. Oliveira, M. D. A. S., & Rossetto, A. M. (2014). A visão dos gestores de empreendimentos de hospedagem certificados em sustentabilidade pela NBR 15401:2006. *Revista de Administração Da UFMS*, 7(3), 403–421. <https://doi.org/10.5902/198346598907>
22. Park, J.-H. and Kim, N.-J. (2023). *Influence of hotel guests' perception of ESG management importance on their willingness to accept losses through perceived value, trust, emotional well-being, and brand preference*. 47(7), pp.69–90. doi:<https://doi.org/10.17086/jts.2023.47.7.69.90>.

23. Paula, B. T. de, Silva, F. C. da, & Faria, E. R. de. (2020). Políticas públicas para o turismo sustentável: o caso de Armação dos Búzios – RJ. *Revista Turismo Em Análise*, 31(2), 316–338. <https://doi.org/10.11606/issn.1984-4867.v31i2p316-338>
24. Schenini, P. C., Lemos, R. N., & Silva, F. A. da. (2005). Sistema de gestão ambiental no segmento hoteleiro. *Revista Eletrônica*, 18.
25. SEBRAE. (2023). Armação dos Búzios. SEBRAE. <https://datampe.sebrae.com.br/profile/geo/armacao-dos-buzios#empresas>
26. Yin, R. K. (2015). *Estudo de caso: planejamento e métodos* (5<sup>o</sup>). Bookman.

# HUMAN FACTORS AND NEW VIEWS OF SAFETY APPLIED TO MANAGEMENT SYSTEMS: A SYSTEMATIC LITERATURE REVIEW

**Jose Leonidas Bier Brasileiro**

*Universidade Federal Fluminense*

*Rua Passo da Pátria, 156 Bloco E, sala 324 CEP 24210-240, Brazil*

*j\_leonidas@id.uff.br; leonidas\_bier@hotmail.com*

**Julio Cesar de Faria Alvim Wasserman**

*Universidade Federal Fluminense*

*Rua Passo da Pátria, 156 Bloco E, sala 324 CEP 24210-240, Brazil*

*juliowasserman@id.uff.br*

**Gilson Brito Alves Lima**

*Universidade Federal Fluminense*

*Rua Passo da Pátria, 156 Bloco E, sala 324 CEP 24210-240, Brazil*

*glima@id.uff.br*

## **ABSTRACT**

*Occupational Safety as a science has evolved over time around methodologies based on command-and-control management modes, derived from the PDCA cycle. Management systems such based on ISO 45001:2018 have become popular in many organizations and although efficient, this form of management seems to have reached a plateau of development, as after a certain level, there is no longer significant reduction in accident rates and other typical safety indicators. Traditional management systems consider humans as a problem to be controlled and understand that the origin of issues and accidents are deviations from the activities performed in relation to what was planned. In recent decades, this way of understanding work has been questioned by management methods that consider human factors as central to improving safety results. Such theories are often grouped under the umbrella called "New View" of Safety. This article seeks to investigate whether and how these new theories are applied to management systems.*

**Keywords:** *Human Factors, New Views of Safety, Safety Management Systems*

## **1. INTRODUCTION**

Occupational safety emerged with the Industrial Revolution in the nineteenth century, a time of increased accidents due to greater exposure of workers to dangerous environments. As a late effect of the Industrial Revolution, fostered by industrial advances related to the two great wars of the twentieth century, there was the worldwide dissemination of industry in the post-World War II period. This led to an increase in frequency and severity of accidents, which intensified social pressures to reduce them (Harvey, Waterson & Dainty, 2019), giving rise to Safety regulations. Even with regulations in place, major industrial disasters took place between the 1970s and 1990s. In response to economic demands to reduce costs with accidents, safety management systems based on the PDCA (Plan, Do, Check, Act) cycle emerged (Swuste et al., 2020; Hale et al., 1997). In search of answers to Chernobyl, the concept of Safety Culture emerged to explain safety performance (Busch, 2016). This approach arised due to characteristics of organizations of Soviet industry, with its centralized control and intolerance of opinions. In due proportions, the influence of culture over safety can be found in several organizations. To improve their safety performance, organizations adopted management systems and focused on improving culture. From the 2000s onwards, because of dissatisfaction with results obtained by management systems and investments in cultural development,

researchers began to question prescriptive management, because these considered humans as a problem to be controlled. At this time, management approaches linked to human factors called "New Views of Safety" emerged (Gomes, 2022). New Views of Safety (NV) is a movement of researchers at the forefront of safety science (Rigoletto and Da Silva Junior, 2023), whose focus is to understand the complexity of work environments and human factors involved. The five most relevant approaches of NV are High Reliability Organizations (HRO), Resilience Engineering (RE), Safety II (SII), Safety Differently (SD), and Human and Organizational Performance (HOP). The common factor between them are their roots and development around study of "human error" in the 1970s (Le Coze, 2022). From these origins, the understanding of the need to consider human factors in safety management has arisen. Given that safety management strategies are no longer enough for increasingly complex work systems (Hollnagel, Wears & Braithwaite, 2015), and NV presents itself as an alternative (Cooper, 2022), organizations are reluctant to adopt NV's proposals in its place. In this context, this present work aims to explore the proposal of coexistence of two modes. It is necessary to investigate how "management systems" and NV are inter-related.

## 2. METHODOLOGY

The research used recommendations of the PRISMA method (Page, 2021), carried out in the SCOPUS database. Consultations to Google Scholar were made to check for unavailable references. The time horizon was between 2000 and 2023, except for a seminal article from 1997. The consultations were carried out between January and March 2024. Scientific articles whose keywords indicated Safety Management Systems and Human Factors were included. The search key was: ("Risk management" OR "Risk\_Management" OR "Integrated Management Systems" OR "international management system" OR "Safety management" OR "safety management practices" OR "Safety management systems") AND ("safety i safety ii" OR "system safety" OR "socio technical systems" OR "Human\_Factors" OR "Resilience Engineering" OR "HRO" OR "RE indicators"). Inclusion factors were industrial activity, Western reference, and relevance of author(s), and the main exclusion criterion was abstract analysis, with exclusion of articles not related to human factors and safety management. The documents searched were restricted to articles in English, Portuguese and Spanish languages. Furthermore, seminal articles and books, theses, and relevant dissertation were also included.

## 3. BIBLIOMETRIC RESEARCH

Scientific production increased over the last decades, with growing interest in Figure 1.

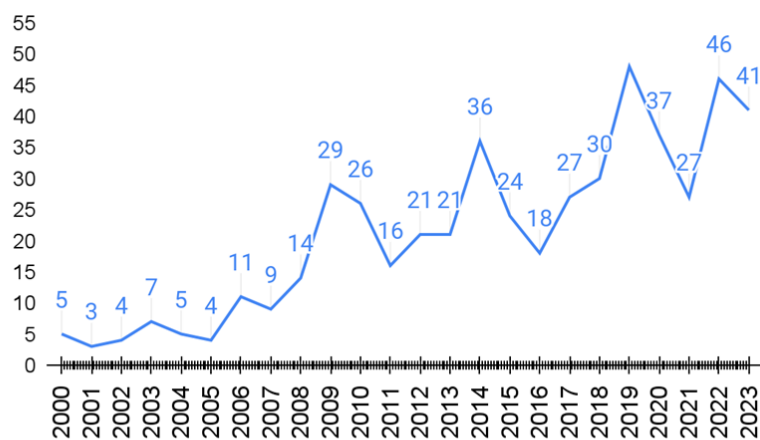

Figure 1: Annual Scientific Production (Authorship, 2024).

The number of articles cited per year was verified. Graph shown on Figure 2.

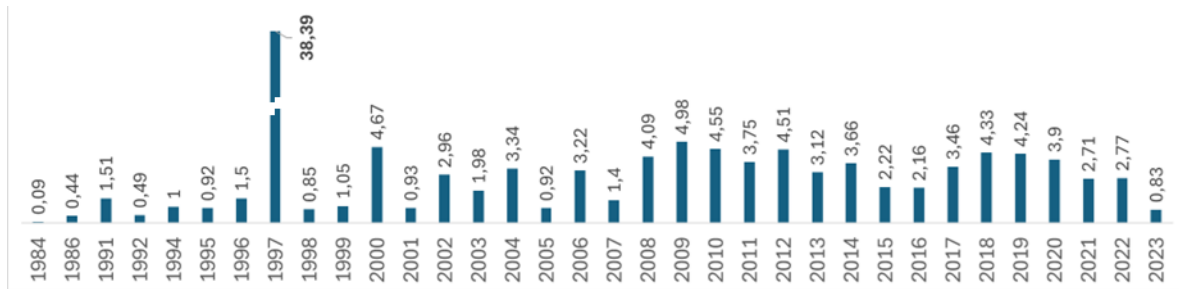

Figure 2: Average Number of Citations per Year (Authorship, 2024).

The peak of citations refers to Rasmussen's article titled “Risk Management In A Dynamic Society: A Modelling Problem”, published in 1997. The idea that risk management should be modeled interdisciplinarily has impacted much of safety science. The most significant journal in the field is Safety Science, followed by the Journal of Loss Prevention in the Process Industries. This has to do with the maturity of the process industry, which is more sensitive to risks than others. The most influential current authors to write about safety management systems and human factors between the 2000 and 2023 are Salmon P. M. with ten publications, followed by Khan F. and Stanton N.A., both with nine publications each, Saurin T.A., Waterson P., Mannan M.S., and Pasman H.J. with eight, seven, six and five publications respectively, covering 78% of the volume extracted. The word cloud from the keywords of the articles is shown in Figure 3.



Figure 3: Keyword Cloud of Selected Articles (Authorship, 2024).

The cloud indicates big issues to be Risk Management and Risk Assessment. Human, Humans, Human Engineering denote the importance of human factors. The co-occurrence network correlates the subjects researched in Figure 4.





<b>Author</b>	<b>Title</b>	<b>Approach</b>	<b>Method</b>	<b>Summary Conclusion</b>
Carim, G.C. & Saurin, T.A.	A Framework For Identifying And Analyzing Sources Of Resilience And Brittleness: A Case Study Of Two Air Taxi Carriers	Resilience Engineering	Case Study	Identifying and transforming sources of fragility and resilience in air taxi companies
Peñaloza, G.A.; Saurin, T.A.; Formoso C.T. & Herrera, I.A.	A Resilience Engineering Perspective Of Safety Performance Measurement Systems: A Systematic Literature Review	Resilience Engineering	Literature Review	Interactions between RE and performance measurement were identified. It may be possible to leverage the strengths of non-ER-oriented safety performance measurement systems.
Steen, R. & Aven, T.	A Risk Perspective Suitable For Resilience Engineering	Resilience Engineering	Literature Review	Conceptual framework for ER. Perspective (A, C, U) of evaluation of events 'A', consequences 'C' and uncertainties 'U' explain how the risk of an activity is understood by the uncertainty about it and its severity.
Leveson, N.	A Systems Approach To Risk Management Through Leading Safety Indicators	Systems Thinking	Literature Review	STAMP/STPA is the basis for background identification and its use in risk management programs. Hazards are identified and used to derive safety constraints and safety requirements from the system. Hazards are categorized in relation to the potential severity and vulnerability of the worst case.
Darabnia, B. & Demichela, M.	Analysis And Classification Of Occupational Data: A Practical Comparison	Human Factors	Literature Review	Human error is a consequence, not a cause, and errors are shaped and caused by the workplace and organizational factors. Repeated mistakes need to be addressed with systematic methods such as HFACS.
Marais, K.; Saleh, J.H. & Leveson, N.G.	Archetypes For Organizational Safety	Systems Thinking	Literature Review	Organizational safety archetypes. 1. Stagnant safety practices; 2. Short-term safety improvements; 3. Pressure to circumvent safety procedures; 4. Inadequate safety feedback and learning; 5. Unintended consequences of interventions; 6. Organizational drift toward failure.
Stroeve, S.; Smeltink, J. & Kirwan, B.	Assessing And Advancing Safety Management In Aviation	Management System	Interviews	The importance of safety management systems (SMS) in aviation and the need for continuous safety improvement. Highlighted importance of human factors in SGS.
Pariès, J.; Macchi, L.; Valot, C. & Deharvengt, S.	Comparing Hros And Re In The Light Of Safety Management Systems	HRO; Resilience Engineering; Management System	Literature Review	HRO and RE are seen as similar schools of thought, both inspired by the theory of complex adaptive systems
Dağdeviren,	Developing A Fuzzy	Management	Case Study	A fuzzy analytical hierarchical process

M. & Yüksel, I.	Analytic Hierarchy Process (Ahp) Model For Behavior-Based Safety Management	System; Behavior-Based Safety		model for behavior-based safety management highlights the importance of identifying and correcting faulty behaviors in work systems.
Pilanawithana, N.M.; Feng, Y.; London, K. & Zhang, P.	Framework For Measuring Resilience Of Safety Management Systems In Australian Building Repair And Maintenance Companies	Resilience Engineering; Management System	Structural Equation	Developing the resilience of safety management systems is crucial to improving safety performance in building repair and maintenance companies.
Fabiano, B.; Pettinato, M.; Reverberi, A. P. & Currò, F.	Human Factors And Safety Management: A Field Study On Safety Performance In The Process Industry	Management System; Human Factors	Survey	Address risky behavior, improve compliance with safety procedures, improve communication, and promote strong safety culture to improve safety in the process industry.
Peçiflo, M.	Identification Of Gaps In Safety Management Systems From The Resilience Engineering Perspective In Upper And Lower-Tier Enterprises	Resilience Engineering; Management System	Survey	ER was developed as a response to the limitations of traditional safety and the need for a new perspective on safety. ER and the concept of trade-offs provide essential shifts in perspective for safety management.
Karanikas, N.; Weber, D.; Bruschi, K. & Brown, S.	Identification Of Systems Thinking Aspects In Iso 45001:2018 On Occupational Health & Safety Management	Systems Thinking	Delphi	It identifies principles of sociotechnical systems within the ISO 45001 standard. It recognizes the consideration of human factors, and the need to manage performance variability through structured channels.
Trotter, M.J.; Salmon, P.M. & Lenné, M.G.	Impromaps: Applying Rasmussen'S Risk Management Framework To Improvisation Incidents	Systems Thinking	Case Study	Use of Impromaps as an analysis methodology to examine improvisation incidents, demonstrating its ability to identify factors at all levels of the system and describe relationships between factors.
Foster, C.J.; Plant, K.L. & Stanton, N.A.	Maladaptation In Air Traffic Management: Development Of A Human Factors Methods Framework	Resilience Engineering; Systems Thinking	Delphi	Importance of Human Factors methods in the analysis of adaptation and decision-making in complex sociotechnical systems such as air traffic. Safety management interventions can lead to unforeseen, maladaptive and emergent effects.
Glendon, A.I. & Stanton, N.A.	Perspectives On Safety Culture	Safety Culture	Literature Review	It emphasizes the importance of understanding and addressing organizational and safety culture in the context of human factors.
Jain, P.; Diangelakis, N. A.; Pistikopoulos, E.N. & Mannam M.S.	Process Resilience Based Upset Events Prediction Analysis: Application To A Batch Reactor	Resilience Engineering	Survey	The Process Resilience Analysis Framework (PRAF) provides a holistic approach to understanding system vulnerabilities, resiliency, and operational safety.
Saurin, T.A.; Júnior,	Proposals Of Improvements To A Method For Assessing	Resilience Engineering;	Case Study	The application of RE in the assessment of occupational safety and health

G.C.C.	Health And Safety Management Systems;	Management System		management systems allows for a deeper analysis of resilience and a more comprehensive understanding of safety performance
Rasmussen N, J.	Risk Management In A Dynamic Society: A Modelling Problem	Risk Management	Literature Review	Risk management should be modeled by interdisciplinary studies, considering it as a control problem and representing the control structure involving all levels of society for each specific hazard category.
Moorkamp M.; Kramer, E.H.; Van Gulijk, C. & Ale, B.	Safety Management Theory And The Expeditionary Organization: A Critical Theoretical Reflection	Systems Theory; Resilience Engineering	Case Study	The inconsistent and implicit use of metatheoretical assumptions in safety management theory has consequences for its applicability. Safety management systems and RE theories may have limitations in addressing complexities.
Accou, B. & Carpinelli, F.	Systematically Investigating Human And Organisational Factors In Complex Socio-Technical Systems By Using The "Safety Fractal Analysis" Method	Accident Analysis	Literature Review	Importance of focusing on assessing the capacity of organizations to manage critical variability and the daily functioning of socio-technical systems in accident investigations.
Dallat, C.; Salmon, P.M. & Goode, N.	Testing The Validity Of The Networked Hazard Analysis And Risk Management System (Net-Harms)	Systems Thinking	Case Study	Information on how collaborative approaches can increase the effectiveness of risk assessment methods such as Net-HARMS, contributing to better risk management practices.
Accou, B.; Reniers, G.	Towards A New Way Of Understanding The Resilience Of Socio-Technical Systems: The Safety Fractal Analysis Method Evaluated	Systems Thinking; Accident Analysis	Case Study	Accident investigation practices struggle to embrace system theory. SAFRAN offers a structured approach that allows for a balance between system complexity and limitations in conducting in-depth accident analyses.
Kyriakidis, M.	Understanding Human Performance In Sociotechnical Systems – Steps Towards A Generic Framework	Human Factors	Case Study	It emphasizes the need for integration of cognitive and behavioral sciences to provide a solid foundation for understanding human performance in complex sociotechnical systems.
Smith, D.; Veitch, B.; Khan, F. & Taylor, R.	Understanding Industrial Safety: Comparing Fault Tree, Bayesian Network, And Fram Approaches	Resilience Engineering	Case Study	Methods such as FRAM can be adopted to identify vulnerabilities and suggest safety solutions, not limited to learning from past failures.

*Chart 1: Summary of Conclusions, Methods and Associated Management Approaches (Authorship, 2024).*

From the 31 selected texts, most of the analyses were case studies (36%) and literature reviews (36%). In third place, there were some Surveys (12%). The remaining 16% were divided into Delphi studies, interviews and structural equations.

## 5. DISCUSSION

Topics covered in the research are presented in Figure 6.

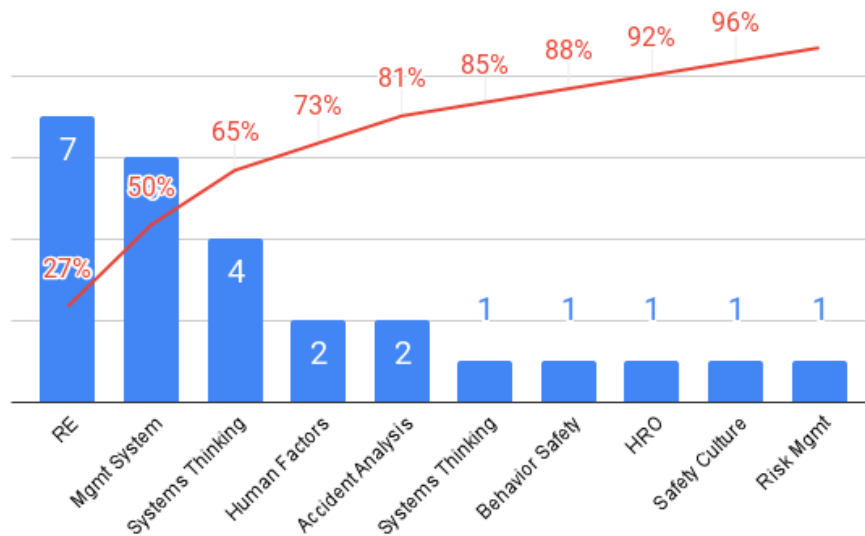

Figure 6: Topics covered in the research (Authorship, 2024).

The most frequent topics addressed were Resilience Engineering (RE) (seven notes, 27%), Management Systems (six notes, increase of 23%) and Systems Thinking (four notes, increase of 15%), totalling 65% in the Pareto line. There are few studies that consider Management Systems and Human Factors at the same time. The appearance of denominations associated with NV was limited. references to RE and HRO were found. Safety Differently, Safety II and HOP were not. Analysis of the co-occurrence network allows us to conclude that the central themes of the research, safety management and human factors were found detached from each other. The collaboration network diagram indicates little international collaboration. Researchers work in small collaborative networks formed by geographical affinities and independent of each other, except between Sasangohar, Son and Moon and Mannan, Jain and Pasman, with collaboration between the United States, Norway and Germany. The most cited article in the research was Rasmussen's. Thus, it is possible to infer that Cognitive Systems Engineering is a precursor of current knowledge about safety science. It's worth highlighting that Safety Culture and Behavior-Based Safety appeared in the review, demonstrating their relative importance, and RE and HRO are the most scientifically relevant NV approaches to date, which differs from the corporate world, with many references to Safety II, Safety Differently and HOP.

## 6. CONCLUSION

It was possible to verify that safety management evolved in the period, with deepening of knowledge related to traditional management systems, safety culture, behavior-based safety and organizational safety archetypes and the emergence of new ideas related to management of complexity and understanding of Human Factors. In the context studied, management systems are considered as the established way of managing safety. However, the emergence of new safety approaches suggests dissatisfaction with the results obtained, or with the effort required to adapt them to today's complex socio-technical environments, without giving due consideration to humans and the context in which they carry out their activities. A series of approaches related to complexity and human factors have emerged in the corporate world and in academia under the common name of NV: RE, HRO, Safety II, Safety Differently and HOP.

Although there is disagreement between their relevance in the market and in academia, with RE and HRO being the most scientifically cited and Safety II, Safety Differently and HOP better known among safety practitioners, the understanding that all of these approaches are different from each other and work in different ways is not clear and could not be verified in this review. More research needs to be done to meet the needs of organizations and safety professionals who apply traditional management systems and need to learn about how to consider human factors and complexity in present work environments through the approaches presented under the NV movement.

#### LITERATURE:

1. Accou, B. & Carpinelli, F. (2022). Systematically investigating human and organisational factors in complex socio-technical systems by using the "SAfety FRactal ANalysis" method. *Applied Ergonomics*, 100, 1 apr.
2. Accou, B. & Reniers, G. (2022). Towards a New Way of Understanding the Resilience of Socio-Technical Systems: The Safety Fractal Analysis Method Evaluated. *Safety*, 8(4), 1 Dez.
3. Busch, C. (2016). Safety Myth 101: Musings on Myths, Misunderstandings and More. *Mind The Risk*, p. 193.
4. Carim, G.C. & Saurin, T.A. (2013). A framework for identifying and analyzing sources of resilience and brittleness: A case study of two air taxi carriers. *Produção*, 23(4), pp. 777–792, oct./dec.
5. Cooper, M.D. (2022). The Emperor has no clothes: A critique of Safety-II. *Safety Science*, 152, 1 ago.
6. Critical Appraisal Tools. (2024). Available at: <<https://jbi.global/critical-appraisal-tools>>. Accessed on: 26 apr.
7. Dağdeviren, M. & Yüksel, I. (2008). Developing a fuzzy analytic hierarchy process (AHP) model for behavior-based safety management. *Information Sciences*, 178(6), pp. 1717–1733, 15 mar.
8. Dallat C.; Salmon, P.M. & Goode, N. (2023). Testing the validity of the Networked Hazard Analysis and Risk Management System (Net-HARMS). *Human Factors and Ergonomics In Manufacturing*, 33(4), pp. 299–311, 1 jul.
9. Darabnia, B. & Demichela, M. (2015). Analysis and classification of occupational data: A practical comparison. *Chemical Engineering Transactions*, 43, pp. 1267–1272.
10. Dudziak, E. [n.d.]. *What is grey literature?* São Paulo: Agency for Libraries and Digital Collections of the University of São Paulo. Available at: <<https://www.abcd.usp.br/noticias/o-que-e-literatura-cinzenta/>>. Accessed on: 26 apr.
11. Fabiano, B. et al. (2019). Human factors and safety management: A field study on safety performance in the process industry. *Chemical Engineering Transactions*, 77, pp. 283–288.
12. Foster, C.; Plant, K. & Stanton, N.A. (2023). Maladaptation in air traffic management: Development of a Human Factors methods framework. *Human Factors and Ergonomics In Manufacturing*, 33(1), pp. 118–146, 1 jan.
13. Glendon, A.I.; Stanton, N.A. (2000). Perspectives on safety culture. *Safety Science*, 34(1-3), pp. 193–214, feb.
14. Gomes, P. (2022). Preface. In: GOMES, P.; MENEZES, G.; RIBEIRO, H. *NEW VISION OF SAFETY at work: A Brazilian perspective*. São Paulo: Editora Nelpa, pp. 11–16.
15. Hale, A.R. et al. (1997). Modelling of safety management systems. *Safety Science*, 26(2).
16. Harvey, E.J.; Waterson, P. & Dainty, A.R.J. (2019). Applying HRO and resilience engineering to construction: Barriers and opportunities. *Safety Science*, 117, pp. 523–533.

17. Hollnagel, E.; Wears, R.L. & Braithwaite, J. (2015). *From Safety-I to Safety-II: A White Paper. The Resilient Health Care Net*. Published simultaneously by the University of Southern Denmark, University of Florida, USA, and Macquarie University, Australia.
18. Jain, P. et al. (2019). Process resilience based upset events prediction analysis: Application to a batch reactor. *Journal of Loss Prevention in the Process Industries*, 62, 1 nov.
19. Karanikas, N. et al. (2022). Identification of systems thinking aspects in ISO 45001:2018 on occupational health & safety management. *Safety Science*, 148, 1 apr.
20. Kyriakidis, M. et al. (2018). Understanding human performance in sociotechnical systems – Steps towards a generic framework. *Safety Science*, 107, pp. 202–215, 1 aug.
21. Leveson, N. (2015). A systems approach to risk management through leading safety indicators. *Reliability Engineering and System Safety*, 136, pp. 17–34.
22. Marais, K.; Saleh, J.H. & Leveson, N.G. (2006). Archetypes for organizational safety. *Safety Science*, 44(7), pp. 565–582, ago.
23. Moorkamp, M. et al. (2014). Safety management theory and the expeditionary organization: A critical theoretical reflection. *Safety Science*, 69, pp. 71–81.
24. Page, M.J. et al. (2021). The PRISMA 2020 statement: an updated guideline for reporting systematic reviews. *Systematic Reviews*, 10(1), 1 dez.
25. Pariès, J. et al. Comparing HROs and RE in the light of safety management systems. *Safety Science*, 117, p. 501–511, 1 aug.
26. Peçiřlo, M. (2020). Identification of gaps in safety management systems from the resilience engineering perspective in upper and lower-tier enterprises. *Safety Science*, 130, 1 oct.
27. Peñaloza, G.A. et al. (2020). A resilience engineering perspective of safety performance measurement systems: A systematic literature review. *Safety Science*, 130, 1 oct.
28. Pilanawithana, N.M. et al. (2023). Framework for measuring resilience of safety management systems in Australian building repair and maintenance companies. *Journal of Safety Research*, 85, pp. 405–418, 1 jun.
29. Rasmussen, J. (1997). Risk management in a dynamic society: A modelling problem. *Safety Science*, 27(2–3), pp. 183–213, nov./dez.
30. Rigoletto, da S.J. (2023). New View of Safety. In: R. Rocha, L. M. Baú (Orgs.), *Dictionary of ergonomics and human factors: the Brazilian context in 110 entries*. 1st ed. Rio de Janeiro: Brazilian Association of Ergonomics - ABERGO.
31. Saurin, T.A. & Carim Júnior, G. (2011). Evaluation and improvement of a method for assessing HSMS from the resilience engineering perspective: A case study of an electricity distributor. *Safety Science*, 49(2), pp. 355–368, feb.
32. Smith, D. et al. (2017). Understanding industrial safety: Comparing Fault tree, Bayesian network, and FRAM approaches. *Journal of Loss Prevention in the Process Industries*, 45, pp. 88–101, 1 Jan.
33. Steen, R. & Aven, T. (2011). A risk perspective suitable for resilience engineering. *Safety Science*, 49(2), pp. 292–297, feb.
34. Stroeve, S.; Smeltink, J. & Kirwan, B. (2022). Assessing and Advancing Safety Management in Aviation. *Safety*, 8(2), 1 jun.
35. Swuste, P. et al. (2020). Occupational safety and safety management between 1988 and 2010: Review of safety literature in English and Dutch language scientific literature. *Safety Science*, 121, pp. 303–318.
36. Trotter, M.; Salmon, P.M. & Lenné, M.G. (2014). Impromaps: Applying Rasmussen's Risk Management Framework to improvisation incidents. *Safety Science*, 64, pp. 60–70.
37. Viana, G. (2019). Occupational Safety: and its importance in the strategic management of a company. *Science & Innovation Journal*, pp. 74–77, 27 jul.

# APPLICATIONS OF MACHINE LEARNING AND ARTIFICIAL INTELLIGENCE IN THE OIL AND GAS INDUSTRY: A STUDY OF KEYWORDS AND RESEARCH RESULTS

**Marcelo dos Santos Povoas**

*Universidade Federal Fluminense, R. Passo da Pátria, 152-470 - São Domingos,  
Niterói - RJ, 24210-240, Brazil  
marcelopovoas@id.uff.br*

**Severino Virginio Martins Neto**

*Universidade Federal do Rio de Janeiro, R. Antônio Barros de Castro,  
119 - Cidade Universitária, Rio de Janeiro - RJ, Brazil  
severino\_virginio@poli.ufrj.br*

**Jessica Freire Moreira**

*Universidade Federal Fluminense. R. Passo da Pátria, 152-470 - São Domingos,  
Niterói - RJ, 24210-240, Brazil  
jessicafreiremoreira@id.uff.br*

**Gilson Brito Alves Lima**

*Universidade Federal Fluminense, R. Passo da Pátria, 152-470 - São Domingos,  
Niterói - RJ, 24210-240, Brazil  
glima@id.uff.br*

## **ABSTRACT**

*The integration of advanced machine learning (ML) and artificial intelligence (AI) techniques in the oil and gas industry is rapidly evolving, focusing on improving operational predictions and optimizations. This study investigates the frequency and interconnectedness of key terms associated with these technologies through network diagrams and academic research results. An extensive search in the Scopus database revealed significant trends and patterns, highlighting the central role of forecasting and optimization within the industry. The interdisciplinary nature of the research underscores the need for collaboration across various fields to tackle complex challenges. While data quality and infrastructure pose challenges, the potential for enhanced efficiency, reduced costs, and increased safety through AI and ML applications is substantial. Case studies demonstrate the practical benefits, and future advancements promise deeper integration of these technologies into industry operations.*

**Keywords:** *Machine Learning, Artificial Intelligence, Oil and Gas Industry and Environment*

## **1. INTRODUCTION**

In the oil and gas sector, the importance of artificial intelligence (AI) has been widely recognized, with several studies focusing on the challenges and opportunities associated with the use of this technology. Velasco (2022) conducted research on challenges and solutions related to AI in the oil and gas industry, highlighting the need to address issues such as data privacy, the explainability of AI models, and the demand for qualified professionals. Similarly, Kaur *et al.* (2023) reviewed the application of AI in the oil and gas sector and identified several challenges and directions for future research, emphasizing the need to develop robust AI algorithms that can effectively detect and respond to operational problems. Furthermore, Nishant *et al.* (2020) discussed the evolving landscape of operational challenges and the potential of AI to address them, highlighting the importance of adopting AI techniques to improve prediction and response capabilities.



Artificial intelligence has emerged as a significant technology in the oil and gas sector, and several studies have explored its role and implications. Ahmad *et al.* (2021) provided an overview of AI and its role in the oil and gas sector, discussing various applications including production forecasting, vulnerability assessment, and incident response. Similarly, Zhuang *et al.* (2021) carried out comprehensive research on the application of AI in the oil and gas sector, exploring various AI techniques such as machine learning (ML) and natural language processing and their use in different areas of the sector. In another study, Yousuf and Wahid (2021) examined the current challenges and future directions of AI in the oil and gas sector, analyzing different aspects including intrusion detection, seismic data analysis, and risk assessment. Iqbal *et al.* (2021) conducted a systematic literature review to explore the role of AI in the oil and gas sector. Their study provides an overview of AI applications in different domains such as intrusion detection, seismic data analysis, and risk assessment. Similarly, Wiafe *et al.* (2020) conducted a systematic literature review to examine the use of AI in the oil and gas sector, focusing on the applications of AI in anomaly detection and intrusion detection systems. Minh *et al.* (2022) provided a review about the need for more research and development to increase the effectiveness of AI-based solutions, also discussing challenges associated with AI such as algorithmic bias and privacy concerns, and proposing potential solutions. Artificial intelligence and machine learning have emerged as a dynamic duo in the oil and gas sector, as highlighted in several research studies. Chen (2020) explored the synergistic relationship between AI and the oil and gas industry, discussing the application of AI and ML techniques in various tasks, including anomaly detection, seismic data analysis, and vulnerability assessment. Similarly, Shah *et al.* (2019) provided a review of the role of AI and ML in the oil and gas sector, focusing on the use of techniques for threat detection, anomaly detection, and risk assessment. The benefits and limitations in tackling emerging threats, highlighting the importance of leveraging these technologies to automate security operations, improve incident response and strengthen operational defenses (SHAH *et al.*, 2019). In a recent review and analysis of current technologies, Zhang *et al.* (2022) investigated the application of AI in the oil and gas sector, examining the use of techniques such as natural language processing and deep learning in areas such as anomaly detection, network security, and user authentication. The authors analyzed the strengths and limitations of these technologies in solving operational challenges and discussed future perspectives in the field (ZHANG *et al.*, 2022). Pan and Zhang (2021) conducted a comprehensive review that explores the role of AI in the industry, discussing the various applications including anomaly detection and network security. The authors analyzed the strengths and limitations of AI-based systems and provided insights into the challenges and future directions of AI in this domain (ZHANG, 2021). Similarly, Farivar *et al.* (2020) presented a systematic review of the literature on the intersection between artificial intelligence and the oil and gas sector, examining existing literature to identify key themes and trends in this area, highlighting the use of AI techniques such as machine learning, deep learning and natural language processing for tasks such as anomaly detection, intrusion detection and vulnerability assessment, also discussing the potential risks and ethical considerations associated with the use of AI in the oil and gas sector. In another comprehensive survey, Morovat and Panda (2020) investigated the application of artificial intelligence in the oil and gas sector, covering a wide range of topics including AI-based threat intelligence, intrusion detection, and security analysis, discussing the benefits of automating operations, improving incident response, and increasing the overall resilience of operating systems, while also identifying challenges and future research directions for leveraging AI in the industry.

## **2. METHODOLOGICAL APPROACH**

The integration of advanced machine learning and artificial intelligence techniques in the oil and gas industry has been an area of growing interest and development. This section explores



The figure 2, keyword network diagram provides a clear visualization of the interrelationships between key concepts in the literature. In the image, we see that "forecasting" and "gas industry" are central terms, indicating the prevalence of these topics in academic documents. Other frequently connected words include "artificial intelligence," "artificial neural network," and "infill drilling." This network illustrates how forecasting plays a critical role in the gas industry, often being associated with artificial intelligence techniques and neural networks. Detailed analysis of keywords and their frequencies, as illustrated in the occurrences table, provides additional insights into the most discussed topics. Terms such as "prediction", "oil wells", "decision trees", and "petroleum industry" appear with high frequency and link strength. This indicates that prediction and data analysis are fundamental components of machine learning applications in the oil and gas industry, with a particular interest in specific methods such as decision trees. Finally, the distribution of documents found by area of knowledge, as shown in the last table, reflects the interdisciplinary nature of research in this area. The most represented disciplines include energy, Earth sciences, engineering, computer science and mathematics. This distribution highlights the need for a multi-faceted approach to addressing the complex and interconnected challenges present in applying machine learning and artificial intelligence technologies in the oil and gas industry.

### **3. INTEGRATION OF ARTIFICIAL INTELLIGENCE AND MACHINE LEARNING TECHNIQUES IN THE OIL AND GAS INDUSTRY: EXPANDING KEYWORD STUDY AND RESEARCH RESULTS**

The growing importance of artificial intelligence and machine learning techniques in the oil and gas industry is evident from a detailed analysis of the most frequent keywords and their interconnections in academic articles. This section expands on the initial discussion by providing a more comprehensive look at how these technologies are being applied to improve operations and efficiency in the industry.

#### **3.1. Analysis of Keywords and Connection Networks**

Keyword network diagrams present a graphical view of the relationships between relevant terms. In one of the most complex diagrams, the words "forecasting" and "gas industry" emerge as central nodes, demonstrating their importance in current research. Terms such as "artificial intelligence", "artificial neural network", "infill drilling", and "machine learning algorithms" are strongly connected, suggesting that these technologies are often used for predictions and optimizations in the petroleum industry and gas.

Forecasting:

- **Importance in Industry:** Forecasting is crucial in the oil and gas industry because it allows companies to anticipate and plan production, identify market trends, and make informed decisions about investments and operations.
- **Technological Applications:** Technologies such as machine learning and artificial intelligence are used to improve the accuracy of forecasts, helping to model market behavior, predict energy demand, and optimize the production and distribution of resources.

The gas industry is a key sector in the global energy mix. With increasing demand for energy and the transition to cleaner energy sources, natural gas is seen as an important transition fuel. The application of advanced technologies such as artificial neural networks and machine learning algorithms is revolutionizing the gas industry. These technologies are used to improve exploration and production efficiency, reduce costs and minimize environmental impacts.

Forecasting in the gas industry involves not only anticipating demand and prices, but also modeling production and managing reserves. This is essential to ensure supply stability and maximize profitability. The integration of artificial intelligence and machine learning techniques in forecasting allows for more sophisticated and accurate analyses. For example, artificial neural networks can be used to predict future production based on historical and real-time data. The network also highlights the intersection of specific technical terms with practical applications. For example, "well logging" and "seismic waves" are strongly associated with "machine learning", indicating the use of ML techniques for analyzing seismic data and log profiles. wells. Similarly, terms such as "long short-term memory" and "support vector machines" indicate the use of advanced ML techniques in forecasting and data analysis tasks. complexes.

### 3.2. Advanced Search Results

Advanced queries carried out in academic databases reveal a significant amount of documents focused on the application of AI and ML in the oil and gas industry. Searching for terms such as "Deep Learning", "Machine Learning", "Artificial Intelligence", and "Oil and Gas" resulted in 663 documents, indicating a vast body of knowledge available. This research is crucial for identifying trends, knowledge gaps, and opportunities for future investigation. A variation of the search including the term "Asset" limited the results to 61 documents, suggesting a more focused niche within the broader context of forecasting and optimization. This specific approach can be useful for studies aimed at asset management and predictive maintenance, areas critical to operational efficiency in the oil and gas industry.

### 3.3. Frequency and Connectivity of Keywords

The keyword occurrence table (figure 3) provides a quantitative view of trends in the literature. "Prediction", with 100 occurrences, leads the list, followed by "oil wells" and "decision trees", both with 90 occurrences. The high frequency of these terms reflects the emphasis on forecasting and data-driven decision making in the oil and gas industry.

Keyword	Occurrences	Total link strength
forecasting	495	6812
machine learning	453	5382
gas industry	321	4278
petroleum prospecting	180	2626
learning algorithms	167	2421
machine-learning	179	2337
learning systems	165	2303
neural networks	156	2097
deep learning	168	2005
petroleum reservoir engineering	129	1954
artificial intelligence	172	1932
infill drilling	125	1831
petroleum reservoirs	120	1809
oil and gas industry	134	1733
gasoline	122	1690
support vector machines	94	1451
artificial neural network	91	1390
oil well logging	85	1381
prediction	100	1371
oil wells	90	1320
prediction	100	1371
oil wells	89	1320
decision trees	90	1316
petroleum industry	96	1302
well logging	78	1253
gases	86	1208

Figure 3: Keyword occurrence

Source: The authors (2024).

The total link strength, which measures the interconnectedness of terms, is also high for words such as "petroleum industry", "well logging", and "gases". This indicates that these topics not only appear frequently, but are also strongly connected to other areas of research, highlighting their central importance, seen in the figure 4.



Predictive maintenance techniques, for example, can predict failures in critical equipment before they occur, avoiding unplanned downtime and reducing maintenance costs.

### **3.6. Case Studies and Practical Applications**

Case studies across different segments of the oil and gas industry show the positive impact of applying AI and ML. Predictive models based on artificial neural networks can be used to forecast oil well production, helping companies make informed decisions about field operations. In the field of seismic exploration, deep learning algorithms have been applied to improve the interpretation of seismic data, identifying hydrocarbon reservoirs with greater precision. These advancements not only increase efficiency but also minimize the risks associated with oil and gas exploration and production.

### **3.7. Future of AI and ML in the Oil and Gas Industry**

The future of applying AI and ML in the oil and gas industry looks promising. With the continued advancement of artificial intelligence technologies and the increasing availability of data, machine learning-based solutions are expected to become even more integrated into daily industry operations. Collaboration between academia, industry and governments will be crucial to accelerate the development and implementation of these technologies. Furthermore, training professionals with AI and ML skills will be essential to sustain this growth. Specific training and skills development programs can prepare the workforce to deal with emerging technologies and maximize their potential.

#### *3.7.1. Oil and Gas Industry and Environment*

The oil and gas sector has a significant impact on the environment, which makes environmental considerations crucial in this sector. Emissions of greenhouse gases, such as carbon dioxide (CO<sub>2</sub>) and methane (CH<sub>4</sub>), resulting from the burning of fossil fuels, contribute to global warming and climate change. Additionally, operations in the sector can release air pollutants such as sulfur dioxide (SO<sub>2</sub>), nitrogen oxides (NO<sub>x</sub>) and volatile organic compounds (VOCs), causing air quality and health problems. Water contamination is another environmental concern. Processes such as hydraulic fracturing (fracking) can lead to contamination of groundwater with chemicals used in fracking fluids. Water produced during extraction may contain harmful substances, requiring appropriate treatment before disposal or reuse. Additionally, oil spills and leaks, both on land and at sea, can have devastating effects on ecosystems, wildlife and local communities, while infrastructure construction and extraction activities can disrupt natural habitats. To address these issues, technologies such as Artificial Intelligence (AI) and Machine Learning (ML) are being used. AI and ML can perform predictive analytics to predict potential risks, such as equipment failures or likelihood of spills, enabling preventive measures to be taken. AI-powered sensor networks can monitor environmental parameters in real time, providing early warnings for leaks or emissions. Additionally, ML algorithms can optimize drilling and production processes to minimize energy consumption and reduce emissions. Spill detection and response is also improved with AI image analysis, which can quickly and accurately identify oil spills, enabling faster response times. ML models can simulate different spill scenarios and recommend effective response strategies to mitigate environmental impact. In waste management, AI can optimize the treatment of produced water, ensuring the removal of harmful substances before disposal or reuse, and identify opportunities to reduce waste generation in operations through better resource management and process adjustments. Sustainable practices in the oil and gas sector include integrating renewable energy sources, such as solar and wind, into operations to reduce the carbon footprint.

Carbon capture and storage (CCS) technologies are being developed to capture CO<sub>2</sub> emissions from industrial processes and store them underground to prevent them from entering the atmosphere. The sector is also exploring ways to reuse and recycle materials, reducing waste and resource consumption. Implementing Environmental Management Systems (EMS) helps companies systematically manage their environmental impacts, setting goals for continuous improvement.

#### **4. CONCLUSION**

In conclusion, the integration of advanced machine learning and artificial intelligence techniques in the oil and gas industry is a rapidly expanding field with significant potential to enhance operational predictions and optimizations. Through a detailed examination of academic research and keyword analysis, this study highlights the prevalent themes and trends in the literature, revealing a strong focus on forecasting and optimization methods. The comprehensive keyword network diagrams demonstrate the centrality of terms like "forecasting" and "gas industry," with frequent connections to "artificial intelligence" and "artificial neural networks." This indicates that AI and ML are being heavily utilized for predictive purposes in the industry. The advanced search results further reinforce this, showing a substantial body of research focused on the application of these technologies to improve industry operations. Moreover, the interdisciplinary nature of this research, spanning areas such as energy, Earth sciences, engineering, computer science, and mathematics, underscores the complexity and interconnectedness of challenges in the oil and gas sector. This multi-faceted approach is essential for developing innovative solutions that can address the industry's diverse needs. While there are challenges, including data quality and integration, the opportunities presented by AI and ML are vast. Techniques such as predictive maintenance can significantly reduce operational costs and increase efficiency by anticipating equipment failures before they occur. Case studies illustrate the tangible benefits of these technologies, such as optimized drilling processes and enhanced seismic data interpretation. The intersection of the oil and gas sector with environmental considerations is complex and multifaceted. By leveraging AI and ML technologies, the industry can better address its environmental challenges, improving sustainability and reducing its ecological footprint. These technologies enable more efficient operations, proactive risk management and innovative solutions to minimize environmental impact, contributing to a more sustainable future. Looking ahead, the future of AI and ML in the oil and gas industry appears promising. Continued technological advancements, coupled with increased data availability, are expected to further embed machine learning solutions into everyday operations. Collaboration across academia, industry, and government, along with specialized training programs, will be crucial in driving this growth and ensuring that the workforce is equipped to leverage these emerging technologies fully.

#### **LITERATURE:**

1. Ahmad, S. F.; Rahmat, M. K.; Mubarik, M. S.; Alam, M. M.; Hyder, S. I. (2021) Artificial Intelligence and Its Role in Education. *Sustainability*, Vol. 13.
2. Chen, Z. (2020) Deep Learning for Cybersecurity: A Review. 2020 International Conference on Computing and Data Science (CDS), Stanford, CA, USA, pp. 7-18.
3. Collins, C., Dennehy, D., Conboy, K., Mikalef, P. (2021) Artificial intelligence in information systems research: A systematic literature review and research agenda. *International Journal of Information Management*, Vol. 60.
4. Farivar, F., Haghghi, M. S., Jolfaei, A., Alazab, M. (2020) Artificial intelligence for detection, estimation, and compensation of malicious attacks in nonlinear cyber-physical systems and industrial IoT. *IEEE Transactions on Industrial Informatics*, Vol. 16(4), pp. 2716-2725.

5. Iqbal, M. J., Javed, Z., Sadia, H., Qureshi, I. A., Irshad, A., Ahmed, R., Malik, K., Raza, S., Abbas, A., Pezzani, R., Sharifi-Rad, J. (2021) Clinical applications of artificial intelligence and machine learning in cancer diagnosis: looking into the future. *Cancer Cell Int.*, Vol. 21(1):270.
6. Kaur, R., Gabrijelčič, D., Klobučar, T. (2023) Artificial intelligence for cybersecurity: Literature review and future research directions. *Information Fusion*, Vol. 97.
7. Minh, D., Wang, H. X., Li, Y. F., Nguyen, T. (2022) Explainable artificial intelligence: a comprehensive review. *Artif Intell Rev*, Vol. 55, pp. 3503–3568.
8. Morovat, K., Panda, B. (2020) A Survey of Artificial Intelligence in Cybersecurity. 2020 International Conference on Computational Science and Computational Intelligence (CSCI), Las Vegas, NV, USA, pp. 109-115.
9. Nishant, R., Kennedy, M., Corbett, J. (2020) Artificial intelligence for sustainability: Challenges, opportunities, and a research agenda, *International Journal of Information Management*, Vol. 53.
10. Pan, Y., Zhang, L. (2021) Roles of artificial intelligence in construction engineering and management: A critical review and future trends. *Automation in Construction*, Vol. 122.
11. Shah, P., Kendall, F., Khozin, S., Goosen, R., Hu, J., Laramie, J., Ringel, M., Schork, M. (2019) Artificial intelligence and machine learning in clinical development: a translational perspective. *npj Digit. Med.* Vol. 2.
12. Velasco, C. (2022) Cybercrime and Artificial Intelligence. An overview of the work of international organizations on criminal justice and the international applicable instruments. *ERA Forum*, Vol. 23, pp. 109–126.
13. Wiafe, I., Koranteng, F. N., Obeng, E. N., Assyne, N., Wiafe, A., Gulliver, S. R. (2020) Artificial Intelligence for Cybersecurity: A Systematic Mapping of Literature. in *IEEE Access*, Vol. 8, pp. 146598-146612.
14. Yousuf, M., Wahid, A. (2021) The role of Artificial Intelligence in Education: Current Trends and Future Prospects. 2021 International Conference on Information Science and Communications Technologies (ICISCT), Tashkent, Uzbekistan, pp. 1-7.
15. Zhang, Z., Ning, H., Shi, F., Farha, F., Xu, J., Zhang, F., Choo, K. R. (2022) Artificial intelligence in cyber security: research advances, challenges, and opportunities. *Artif Intell Rev*, Vol. 55, pp. 1029–1053.
16. Zhuang, P., Zamir, T., Liang, H. (2021) Blockchain for Cybersecurity in Smart Grid: A Comprehensive Survey," in *IEEE Transactions on Industrial Informatics*, Vol. 17, No. 1, pp. 3-19.



## **HIERARCHIZATION MODEL APPLIED IN OIL AND GAS COMPANIES USING THE TRIPLE BOTTOM LINE**

**Juliana Damaris Candido**

*Universidade Federal Fluminense, Brazil  
julianadamaris@id.uff.br*

**Ruben Huamanchumo Gutierrez**

*Universidade Federal Fluminense, Brazil  
rh\_gutierrez@id.uff.br*

**Gilson Brito Alves Lima**

*Universidade Federal Fluminense, Brazil  
glima@id.uff.br*

### **ABSTRACT**

*Multicriteria Decision Aid methods have been applied to different types of problems, and in different areas of knowledge, with a tendency towards increased application in contexts related to the sustainability situation. In this sense, the present study aims to present a Hierarchization Model applied to companies in the oil and gas sector using the Triple Bottom Line with the intention of providing a greater relationship between the theoretical and practical part of sustainability, taking into account economic prosperity, social justice and environmental protection, within its operations. To this end, a robust bibliometric analysis was carried out, which contributed to the design of a theoretical framework that contributed to the thematic and methodological convergence used to achieve the proposed objective. The Empirical Model developed can be used as an input for analyzes that calculate the final score of the Triple Bottom Line. The Model was based on both TOPSIS (Technique for Order Preference by Similarity to Ideal Solution) and the use of GUT Analysis, with weight being assigned to each criterion, taking into account the parameters related to severity, urgency and trend for the Triple Bottom Line Model of oil and gas companies.*

**Keywords:** *Sustainability Management, Triple Bottom Line, TOPSIS, GUT Analysis, Oil and gas*

### **1. INTRODUCTION**

The topic of sustainability is constantly highlighted and is a pertinent topic in business management (LIMA et al., 2024). With the publication of the report "Our Common Future" by Brundtland (1987), the concern with sustainable development and the use of available resources without compromising, but respecting the needs of the future generation, became a reality (BRUNDTLAND, 1987; FERGUS ; RONEY, 2005). Furthermore, according to Gladwin (1995), sustainable development is also linked to improving the population's quality of life. Corporate Sustainability's challenges include identifying its stakeholders and creating long-term financial value in order to reduce impacts on the environment (WILSON, 2003; BANSAL, 2012). Increased concern for the environment and the development of international environmental standards creates the need for companies to develop environmental strategies and programs (SILVA; QUELHAS, 2006). For Wilson (2003), the interdisciplinarity related to the theme of sustainable development goes back to aspects related to the disciplines of economics, ecology, social justice, and Dale (2002) adds the influence of political aspects to this triad. Elkington (1994), created the Triple Bottom Line (TBL) with the intention of providing a greater relationship between the theoretical and practical part of sustainability, taking into account economic prosperity, social justice and environmental protection, within its

operations. There is support for companies and other organizations to take responsibility for their impacts through a common global communication language. Carpentier and Braun (2020), discuss the 2030 Agenda, its 17 Sustainable Development Goals, the SDGs, and 169 goals to be met by governments, civil society, the private sector and all citizens on the collective journey to a sustainable 2030”. According to Magrini, et al., (2013), market sustainability indices aim to score and compare companies in relation to their sustainability management and performance, such as the DJSI, which performs a ranking through a questionnaire specific to the oil and gas sector. On the other hand, reporting guidelines aim to increase companies' transparency by providing indicators that help in the preparation of sustainability reports. The GRI, for example, publishes guidelines for various sectors, but also has a specific notebook for the oil and gas sector. The Global Reporting Initiative (GRI) is an independent international organization that provides standard reports called GRI, and is the best-known structure for voluntary reporting of environmental and social performance for both national companies and other international organizations (Brundtland, 1987). In this context, the Multicriteria Decision Aid methods are applied, which have been applied to different types of problems, in different areas of knowledge (RODRIGUEZ et al., 2013). Multi-criteria methodologies consider the multidimensional and complex nature of problems, verifying the weight of each one of them in decision-making, evaluating or monitoring situations (BANA E COSTA; PIRLOT, 1997). Therefore, the objective of this research is to develop a Hierarchization Model applied to companies in the oil and gas sector using the Triple Bottom Line.

## 2. LITERATURE REVIEW

The French School of Multicriteria Decision Aid presents the Overcoming Method through methods, with their respective seminal references: Electre (ROY, 1968; ROY; BERTIER, 1971; ROY; HUGONNARD, 1981; ROY; SKALKA, 1985; YU, 1992 ; MOUSSEAU), Promethee (BRANS; MARESCHAL; VINCKE, 1984; BRANS; VINCKE; MARESCHAL, 1986) and Regime (HINLOOPEN; NIJKAMP; RIETVELD, 1983). On the other hand, the American School presents the Multiattribute Utility Theory through the methods: Multi attribute Utility Theory (FISHBURN, 1970; KEENEY; RAIFFA, 1976), Simple Multi Attribute Rating Technique (EDWARDS, 1977), Analytic Hierarchy Process (SAATY, 1977; SAATY, 1980), Analytic Network Processes (SAATY, 1996), Measuring Attractiveness by a Categorical Based Evaluation Technique (BANA E COSTA; VANSNICK, 1994). The TOPSIS Method was developed for the first time to solve a multi-attribute decision-making problem (HWANG, 1981), having been exposed in other studies together with other Multi-Criteria Decision Aid methods in the same scenario, eg, AHP and TOPSIS (KUMARASWAMY, et al., 2011), AHP, fuzzy, fuzzy AHP and fuzzy TOPSIS (NAZIM; MOHAMMAD; SADIQ, 2022), fuzzy and TOPSIS (LI; JIN; WANG, 2014), AHP, DEA and TOPSIS (YOUSEFI; HADI-VENCHEH, 2016). According to Lima et al., (2024), the Technique for Ordering Preferences by Similarity to the Ideal Solution (TOPSIS – Technique for Order Preference by Similarity to Ideal Solution), aims to compare the alternatives with the positive ideal solution (PIS – Positive Ideal Solution). Although TOPSIS presents positive and negative distances through Euclidean Distances, TOPSIS-2NE's also demonstrates the possibility of computing TOPSIS; changing the Euclidean Distances by the elliptical length of the eccentricity, as the set of stable potential alternatives; between  $A_i$  and  $A^+$  (considered as decision benefits because they are positive ideal distances  $D_i^+$ ) and between  $A_i$  and  $A^-$  (considered as decision costs because they are negative ideal distances  $D_i^-$ ). While the relative proximity calculation considered as the set of criteria  $C = \{C_1, C_2, \dots, C_k\}$ , where  $C_i$  for each alternative  $A_i$  considering the ideal positive solution  $A^+$ . Where the value of the  $C_i$  index varies from 0 to 1 (SILVA; GOMES, 2020). However, although these two techniques may present weights linked to the decision matrix, for Marshall et al. (2006), the GUT Matrix presents greater accuracy in determining the prioritization of these

problems and risk analysis with technical analyzes related to: (i) severity: how serious is each problem; (ii) urgency: how urgently (the available time) the company has to eliminate this problem, (iii) trend: what is the market trend and its growth potential (COSTA, et al., 2022). The measurement metrics of the GUT Matrix are based on both the 5-point Likert and intensity scale, proposed by Albaum (1997). For Malhotra (2006), the analysis is done by assigning a numerical score to each statement, and can be done through the profile (item by item) or summation (total score). Furthermore, in order to understand how the Triple Bottom Line is being integrated into research and development in the oil and gas sector, bibliometry was carried out in the Scopus Base, taking as an interstice the last 32 years (1996 -2024), taking into account considering the emergence of the term “Triple Bottom Line” as a parameter, and with the search expression: “Triple Bottom Line” AND “oil AND gas”, a total of 48 publications were obtained. Figure 1 shows the number of publications per year and Figure 2 the number of publications per country.

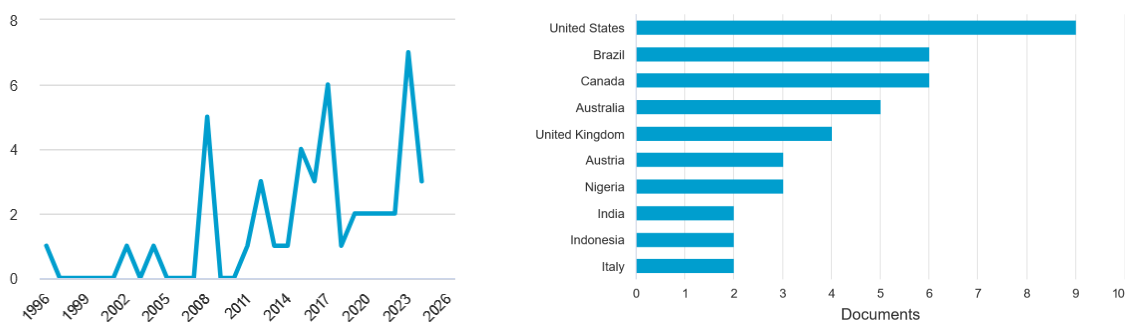

Figure 1: Number of publications per year Figure 2: Number of publications by country  
Source: Research Data

As shown in Figure 1, most documents were published in the years 2023 (7), 2017 (6), and 2018 (5). From the data, it is assumed that although in some periods there was a decrease in the number of publications, there is a tendency for an increase in publications related to the topic, with the majority still being published in the United States (9), followed by Brazil (6), Canada (6), Australia (5), United Kingdom (4), Austria (3), Nigeria (3), India (2), Indonesia (2) and Italy (2), as shown in Figure 2. Figure 3 shows the percentage related to the field of study of publications and Figure 4 shows the quantity related to the type of document.

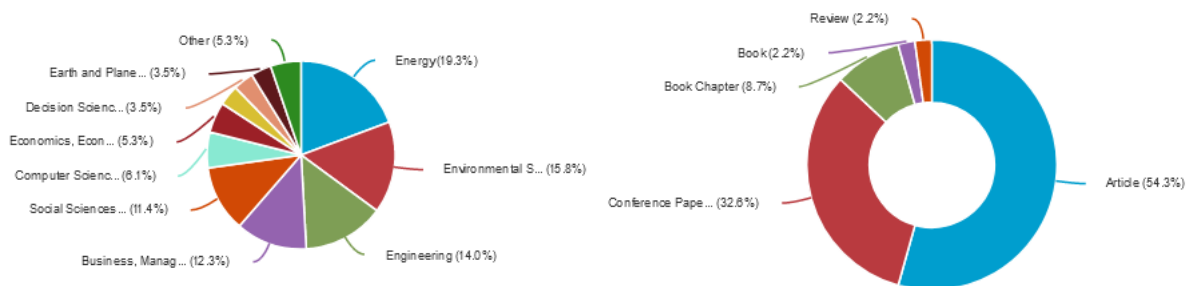

Figure 3: Publications by Area Figure 4: Publications by Type  
Source: Research Data

Furthermore, in relation to bibliometric analysis, the majority of published documents are articles in journals (54.3%), conferences (32.6%), book chapters (8.7%), books (2.2%) and review (2.2%). The energy area presented (19.3%), followed by the environment area (15.8%), engineering (14%), management (12.3%) and social sciences (11.4%).

The data demonstrates convergence with the areas and type of research that is being used as parameters for the current research. Table 1 presents the five publications that obtained the highest number of citations.

Author (year)	Article	Quotes
(Shahriar; Sadiq; Tesfamariam, 2012)	Risk analysis for oil & gas pipelines: A sustainability assessment approach using fuzzy based bow-tie analysis	268
(Gill; Dickinson; Scharl, 2008)	Communicating sustainability: a web content analysis of North American, Asian and European firms	97
(Elhuni; Ahmad, 2017)	Key Performance Indicators for Sustainable Production Evaluation in Oil and Gas Sector	50
(Infante; Mendonça; Purcidonio; Valle, 2013)	Triple bottom line analysis of oil and gas industry with multicriteria decision making	49
(Abdulrahman; Huisingh; Hafkamp, 2015)	Sustainability improvements in Egypt's oil & gas industry by implementation of flare gas recovery	45

*Table 1: Related studies*

*Source: Research Data*

The study by Shahriar, Sadiq, and Tesfamariam (2012) explores how interdependencies between various factors can influence analysis results and introduces fuzzy utility value (FUV) to perform risk assessments for natural gas pipelines using Triple sustainability criteria. Bottom Line (TBL), namely, social, environmental and economic consequences. In research by Gill, Dickinson, and Scharl (2008), automated web content analysis was performed to determine and differentiate 39 oil and gas companies' reports on economic, social, and environmental disclosures in Europe, North America, and Asia. Companies were compared on their disclosures against key terms derived from the Global Reporting Initiative. The article by Elhuni and Ahmad (2017) proposes a set of Key Performance Indicators (KPIs) to assess sustainable production considered appropriate for the oil and gas sector based on the Triple Bottom Line. Infante's study; Mendonça, Purcidonio and Valle (2013) sought to develop an integrated interpretation of the economic, environmental and social issues of the main companies in the oil and gas sectors in the world, characterizing their activities through sustainability indicators included in the three pillars of the Triple Bottom Line. The research by Abdulrahman, Huisingh, and Hafkamp (2015) was carried out in Egypt's first refinery flue gas recovery project, with the purpose of improving sustainability and promoting Cleaner Production in the Egyptian oil and gas industry.

### 3. METHODOLOGY AND RESEARCH

Regarding the research design, several analyzes and studies were carried out to compose the content. As for the approach, it is a quantitative research, and in relation to the methodological objectives, it is an exploratory and descriptive research. As for the procedures, it is a documentary research. Finally, it is a case study that consists of a deep and exhaustive study of one or a few objects. Using a theoretical framework based on sustainability management, and based on the methodological procedure developed in the study by Senadheera, et al., (2021), we sought to associate and categorize the GRIs of the Sustainability Reports of companies in the Oil Sector and Gas. In this sense, in order to obtain greater robustness in relation to the methodological aspects to be used, a bibliometric analysis was carried out, both in the Scopus

Base and in the Web of Science, with the type of publication classified as articles in journals. The bibliometric analysis aimed to obtain examples of how the Multi-Criteria Decision Method is being integrated into research and development in the field of sustainability. For this, the following were used as a search expression: “Multi-criteria decision method” AND “Sustainability” AND “oil AND gas”, obtaining 17 journals in the interstice of (2020-2024). From the analysis and stratification of these articles in relation to the methodology addressed for the treatment of the case study and data, guidance was obtained for the use of the TOPSIS Model that was used in two of these studies (FETANAT; TAYEBI; MOFID, 2023 ; MENTEN; ÇEKIÇ, 2023; We chose to use the Global Reporting Initiative (GRI), as it adheres to sustainability reporting indicators in companies in the oil and gas sector, as demonstrated in the study by Travassos et al. (2014). A stratification was carried out in relation to non-reported (no criteria) and reported indicators, being subdivided into partially reported (at least one criterion informed) and completely reported (all criteria reported). In possession of the data obtained from oil and gas companies through their respective Sustainability Reports, for a period of five years, The following steps were used to apply TOPSIS (HWANG; YOON, 1981).

- a) **Step 1:** Build decision matrix B, where the lines represent the criteria and the columns represent the alternatives. Therefore, the values of  $b_{i,j}$  represent the score of alternative A in criterion C, according to equation 1.

$$B = [b_{C,A}]_{21 \times 4} \begin{bmatrix} & A_1 & A_2 & A_3 & \dots & A_4 \\ C_1 & b_{1,1} & b_{1,2} & b_{1,3} & \dots & b_{1,4} \\ C_2 & b_{2,1} & b_{2,2} & b_{2,3} & \dots & b_{2,4} \\ C_3 & b_{3,1} & b_{3,2} & b_{3,3} & \dots & b_{3,4} \\ \vdots & \vdots & \vdots & \vdots & \vdots & \vdots \\ C_{21} & b_{21,1} & b_{21,2} & b_{21,3} & \dots & b_{21,4} \end{bmatrix} \begin{matrix} W_i \\ w_1 \\ w_2 \\ w_3 \\ \vdots \\ w_{21} \end{matrix} \quad (1)$$

- b) **Step 2:** Weight and normalize the decision matrix, using equation 2, where the values of  $w_i$  are the values of the weights assigned to each criterion.

$$n_{i,j} = \frac{w_i \times b_{i,j}}{\sqrt{\sum_{i=1}^{21} w_i \times b_{i,j}^2}} \quad (2)$$

- c) **Step 3:** Using equation 3 and equation 4, respectively, calculate the ideal positive (PIS, A+) and negative (NIS, A-) solutions. Where  $n_i^+$  represents the best score achieved and  $n_i^-$  the worst score achieved in the alternatives in the criterion to which it corresponds.

$$A^+ = \{^{MAX}i n_{i,j} | i = 1,2,3, \dots, 21\} = \{n_1^+, \dots, n_j^+, \dots, n_i^+\} \quad (3)$$

$$A^- = \{^{MIN}i n_{i,j} | i = 1,2,3, \dots, 21\} = \{n_1^-, \dots, n_j^-, \dots, n_i^-\} \quad (4)$$

- d) **Step 4:** Determine the distance ( $D_i^+$ ) between the elements of matrix B, after normalized and weighted, and the positive ideal solution using equation 5. In a similar way, we must determine the distance ( $D_i^-$ ) of the elements of matrix B, after normalized and weighted, and the negative ideal solution through equation 6.

$$D_i^+ = \sqrt{\sum_{i=1}^n (n_{i,j} - n_i^+)^2} \tag{5}$$

$$D_i^- = \sqrt{\sum_{i=1}^n (n_{i,j} - n_i^-)^2} \tag{6}$$

e) **Step 6:** Finally, using equation 7, the approximation coefficient (CC<sub>i</sub>) of each alternative is calculated and sorted in descending order. The closer the CC<sub>i</sub> value is to 1, the better the performance of the alternative.

$$CC_i = \frac{D_i^-}{D_i^+ + D_i^-} \tag{7}$$

From this, an Empirical Model was developed that served as input for statistical analyzes to calculate the final Triple Bottom Line score. The model was based on both TOPSIS and the use of the GUT Matrix, with GUT Analysis being used between Step 2 and Step 3 of the TOPSIS Technique described, and the weight assigned to each criterion (w<sub>i</sub>) included in its composition, dimensions related to severity (g<sub>i</sub>), urgency (u<sub>i</sub>) and tendency (t<sub>i</sub>). Regarding the range used for each parameter, there are: (i) weight of each criterion (w<sub>i</sub>) varying from [1/125;1]; (ii) weight of each dimension g<sub>i</sub>, u<sub>i</sub> and t<sub>i</sub> varying from [1;5]. Table 2 exemplifies the GUT Analysis to be used.

	<b>G (5)</b>	<b>U (5)</b>	<b>T (5)</b>	<b>Weights</b>
w <sub>1</sub>	g <sub>1</sub>	u <sub>1</sub>	t <sub>1</sub>	w <sub>1</sub> '=(g <sub>1</sub> *u <sub>1</sub> *t <sub>1</sub> )/125
w <sub>2</sub>	g <sub>2</sub>	u <sub>2</sub>	t <sub>2</sub>	w <sub>2</sub> '=(g <sub>2</sub> *u <sub>2</sub> *t <sub>2</sub> )/125
w <sub>3</sub>	g <sub>3</sub>	u <sub>3</sub>	t <sub>3</sub>	w <sub>3</sub> '=(g <sub>3</sub> *u <sub>3</sub> *t <sub>3</sub> )/125
w <sub>4</sub>	g <sub>4</sub>	u <sub>4</sub>	t <sub>4</sub>	w <sub>4</sub> '=(g <sub>4</sub> *u <sub>4</sub> *t <sub>4</sub> )/125
w <sub>n</sub>	g <sub>n</sub>	u <sub>n</sub>	t <sub>n</sub>	w <sub>n</sub> '=(g <sub>n</sub> *u <sub>n</sub> *t <sub>n</sub> )/125

Table 2: GUT Analysis  
Source: Own elaboration

The use of GUT Analysis aims to guide the weights of the criteria for each of the 3P's (People, Planet, Economic Performance) of the Triple Bottom Line, so that variants of severity, urgency and sustainability trends, associated with to the temporal context of the research.

#### 4. CONCLUSION

The research sought to develop a Hierarchization Model applied to companies in the oil and gas sector using the Triple Bottom Line. The Technique of Similarity by Ideal Solution (TOPSIS) is one of the multi-criteria decision analysis methods that was used to assist sustainability analysis solutions. Although, there are different ways to calculate distances based on potential alternatives. It was proposed to weight and normalize the decision matrix, using GUT Analysis, so that the ideal positive and negative solutions are calculated, based on criteria of severity, urgency and tendency for the Triple Bottom Line Model of companies of oil and gas.

**LITERATURE:**

1. Abdulrahman, A.O., Huisingh, D., Hafkamp, W. (2015). Sustainability improvements in Egypt's oil & gas industry by implementation of flare gas recovery. *Journal of Cleaner Production*, 98, pp. 116–122. DOI: 10.1016/j.jclepro.2014.11.086
2. Albaum, G. (1997) The Likert scale revisited: an alternative version. *Journal of the Market Research Society*, v. 39.
3. Bana E Costa, C. A.; Vansnick, J. C. Macbeth (1994). An interactive path towards the construction of cardinal value functions. *International Transactions in Operational Research*, v. 1, n. 4, p. 489-500. [http://dx.doi.org/10.1016/0969-6016\(94\)90010-8](http://dx.doi.org/10.1016/0969-6016(94)90010-8)
4. Bana e Costa, C. A., Pirlot, M. (1997). Thoughts on the future of the multicriteria field: basic convictions and outlines for a general methodology. In J. Clímaco (Ed.), *Multicriteria analysis* (pp. 562-568). Berlin: Springer. [https://doi.org/10.1007/978-3-642-60667-0\\_53](https://doi.org/10.1007/978-3-642-60667-0_53).
5. Bansal, P., Hoffman, A.J (2012). The Oxford Handbook of Business and the Natural Environment. *Oxford University Press*, New York. <http://dx.doi.org/10.1093/oxfordhb/9780199584451.001.0001>
6. Bhowmik, C., Kaviani, M. A., Ray, A., Ocampo, L. An Integrated Entropy-TOPSIS Methodology for Evaluating Green Energy Sources. *International Journal of Business Analytics*. V.7, n.3, p.44-70. DOI10.4018/IJBAN.2020070104
7. Brans, J. P.; Mareschal, B.; Vincke, P. Promethee: a New Family of Outranking Methods in Multicriteria Analysis. *Washington: North-Holland*, 1984. p. 477-490.
8. Brans, J. P.; Vincke, P.; Mareschal, B. How to select and how to rank projects: The Promethee method. *European Journal of Operational Research*, v. 24, n. 2, p. 228-238, 1986. [http://dx.doi.org/10.1016/0377-2217\(86\)90044-5](http://dx.doi.org/10.1016/0377-2217(86)90044-5).
9. Brundtland, G., Khalid, M., Agnelli, S; Al- Athel, S.; Chidzero, B.; Fadika, L.; Hauff, V. et al (1987). Report of the *World Commission on Environment and Development "Our Common Future"*. Annex to UN General Assembly document A/42/427. New York: United Nations.
10. Carpentier, C.L.; Braun, H. (2020) Agenda 2030 for Sustainable Development: A powerful global framework. *Journal of the International Council for Small Business*, 1:1, 14-23, DOI: 10.1080/26437015.2020.1714356
11. Costa, L.V.B.; Moura, L.A.; Teixeira, B.C.; Monteiro, E.C.B.; Moura Júnior, J.M, de; Cavalcanti, L.R. (2022) Box type buildings: use of GUT Matrix in the analysis of defects of five buildings in Recife-PE and metropolitan region. *Research, Society and Development*, [S. l.], v. 11, n. 9, p. e47111932219, 2022. DOI: 10.33448/rsd.v11i9.32219.
12. Dale, A. (2002) The politics of sustainable development. *Encyclopedia of life support systems*. New York, NY: UNESCO-EOLSS. Available at <http://www.eolss.net/sample-chapters/c13/E1-45-04-06.pdf>. [Accessed 07 Jul. 2024].
13. Edwards, W. (1977). How to use multiattribute utility measurement for social decision making. *IEEE Transactions on Systems, Man and Cybernetics*, v. SMC-7, n. 5, p. 326-340. <http://dx.doi.org/10.1109/TSMC.1977.4309720>
14. Elkington, J. (1994).Triple bottom line revolution: reporting for the third millennium. *Australian CPA*, v. 69, p. 75.
15. Elhuni, R.M., Ahmad, M.M. Key Performance Indicators for Sustainable Production Evaluation in Oil and Gas Sector. (2017). *Procedia Manufacturing*, 11, pp. 718–724. DOI: 10.1016/j.promfg.2017.07.172.
16. Fergus, A.H.; Rowney, J.I. (2005). Sustainable development: Lost meaning and opportunity? *Journal of Business Ethics*, 60(1), 17–27. <https://doi.org/10.1007/s10551-005-2927-9>

17. Fetanat, A., Tayebi, M., Mofid, H. (2023). Water-energy-carbon nexus and sustainability-oriented prioritization of negative emissions technologies for the oil & gas industry: A decision support system under Fermatean fuzzy environment. *Process Safety and Environmental Protection*. 179, pp. 462–483. DOI:10.1016/j.psep.2023.09.037
18. Fishburn, P. C. (1970). Utility theory for decision making. *Operations Research Society of America Publications in operations research*. New York: Wiley,. xiv, 234 p.
19. Gill, D.L., Dickinson, S.J., Scharl, A. (2008). Communicating sustainability: a web content analysis of North American, Asian and European firms. *Journal of Communication Management*, 12(3), pp. 243–262. DOI:10.1108/13632540810899425
20. Gladwin, T. N., Kennelly, J., Krause, T.-S. (1995). Shifting Paradigms for Sustainable Development: Implications for Management Theory. *Academy of Management Review*, 20, 874-907. <https://doi.org/10.2307/258959>
21. Hinloopen, E.; Nijkamp, P.; Rietveld, P. The Regime method: a new multicriteria method. Essays and surveys on multiple criteria decision making. *Lecture Notes in Economics and Mathematical Systems*, v. 209, p. 146-155, 1983. [http://dx.doi.org/10.1007/978-3-642-46473-7\\_13](http://dx.doi.org/10.1007/978-3-642-46473-7_13)
22. Hwang, C.; Yoon, K. (1981) Multiple Attribute Decision Making. Economics and Mathematical Systems, Berlin, 75 p.
23. Infante, C.E.D.D.C., Mendonça, F.M.D., Purcidonio, P.M., Valle, R. (2013). Triple bottom line analysis of oil and gas industry with multicriteria decision making. *Journal of Cleaner Production*, 52, pp. 289–300. DOI: 10.1016/j.jclepro.2013.02.037.
24. Keeney, R. L. (1976) Decisions with Multiple Objectives: preferences and value tradeoffs. *New York: John Willey & Sons*. 569 p.
25. Kumaraswamy, A. H., Bhattacharya, A., Kumar, V., Brady, M. (2011). An Integrated QFD-TOPSIS Methodology for Supplier Selection in SMEs. *Third International Conference on Computational Intelligence, Modelling & Simulation*. Langkawi, Malaysia. DOI: 10.1109/CIMSim.2011.55
26. Li, M., Jin, L., Wang, J. (2014). A new MCDM method combining QFD with TOPSIS for knowledge management system selection from the user’s perspective in intuitionistic fuzzy environment. *Applied Soft Computing*, p. 1-10. <http://dx.doi.org/10.1016/j.asoc.2014.03.008>
27. Lima, J. D.C; Dias, L. C.; Silva, P. C. M. ; Lima, G. B. A. (2021). Sustainability Analysis for Management of Animal Protein Companies supported by a Decision Support Method. In: *XLI - Encontro Nacional de Engenharia de Produção*- <https://abepro.org.br/publicacoes/artigo.asp?e=enegep&a=2021&c=42160>
28. Magrini A., Botelho T., Santos V., Guimarães V. (2013). “Comparative Analysis of Sustainability Standards applicable to the Oil and Gas Industry”. In: *XV Brazilian Energy Congress: Energy Security and Development Economic*. pp. 1-17, Rio de Janeiro.
29. Malhotra, N. K.(2006) *Pesquisa de Marketing: uma orientação aplicada*. Porto Alegre: Bookman.
30. Marshall J. I. et al. *Gestão da Qualidade*. 8.ed. Rio de Janeiro: FGV, 2006.
31. Menten, C., Çekiç, B. (2023). Sürdürülebilirlik Bağlamında G-20 Ülkelerinin Enerji Üretim Kaynaklarına Göre TOPSIS Yöntemiyle Sıralanması. *Sosyoekonomi*, 31(58), pp. 387–408. DOI:10.17233/sosyoekonomi.2023.04.19.
32. Nazim, M., Mohamad, W., Sadiq, M. A comparison between fuzzy AHP and fuzzy TOPSIS methods to software requirements selection. *Alexandria Engineering Journal*. Volume 61, Issue 12, December 2022, Pages 10851-10870. <https://doi.org/10.1016/j.aej.2022.04.005>
33. Rodriguez, D.S.S., Costa, H.G., Carmo, L.F.R.R.S. Multi-criteria decision aid methods applied to PCP problems: Mapping production in journals published in Brazil. *Gestão & produção*, São Carlos, v. 20, n. 1, p. 134-146, 2013



34. Roy, B. (1968). Classement et choix en présence de points de vue multiples. *Revue française d'informatique et de recherche opérationnelle*. Série verte, Volume 2 no. V1, pp. 57-75.
35. Roy, B.; Bertier, P. M. (1971) La methode ELECTRE II: Une methode de classement en presence de criteres multiples. Volume 142 de *Note de travail / Direction scientifique, SEMA* (Metra International) Paris, p. 45. PMid:5161467.
36. Roy, B.; Hugonnard, J. C. (1981). Classement des prolongements de lignes de stations en banlieu parisienne. *Cahiers du LAMSADE*. Paris: Université Dauphine et RATP.
37. Roy, B. M.; Skalka, J. (1985) ELECTRE IS: Aspécts methodologiques et guide d'utilisation. *Cahier du LAMSADE*. Paris: Université de Paris-Dauphine.
38. Saaty, T. L. (1977). A scaling method for priorities in hierarchical structures. *Journal of Mathematical Psychology*, v. 15, n. 3, p. 234-281. [http://dx.doi.org/10.1016/0022-2496\(77\)90033-5](http://dx.doi.org/10.1016/0022-2496(77)90033-5)
39. Saaty, T. L. (1980). *The Analytic Hierarchy Process*. McGraw-Hill, New York. Pittsburg: RWS Publications.
40. Saaty, T. L. (1996). *Decision Making with Dependence and Feedback: The Analytic Network Process*. Pittsburg: RWS.
41. Senadheera, S.S.; Withana, P.A.; Dissanayake, P.D.; Sarkar, B.; Chopra, S.S.; Rhee, J.H.; Ok, Y. S. Scoring environment pillar in environmental, social, and governance (ESG) assessment. *Sustainable Environment*. Vol. 7, No. 1, 1–7. <https://doi.org/10.1080/27658511.2021.1960097>
42. Shahriar, A., Sadiq, R., Tesfamariam, S. (2012). Risk analysis for oil & gas pipelines: A sustainability assessment approach using fuzzy based bow-tie analysis. *Journal of Loss Prevention in the Process Industries*, 25(3), pp. 505–523. DOI: 10.1016/j.jlp.2011.12.007
43. Silva, M.C.; Gomes, C. F.S (2020). TOPSIS-2NE's Proposal. *International Journal of Fuzzy Systems*. 22(4). DOI:10.1007/s40815-020-00871-4
44. Silva, L. S. A.; Quelhas, O. L. G. (2026). Business Sustainability and the Impact on the Cost of Equity of Publicly-Held Companies. *Gestão & produção*, v.13, n.3, p.385-395, set.-dez.
45. Travassos, S.K.M.; Costa, J.I.F.; Silva, W.E.; Araújo, M.L. (2014). Uso dos indicadores essenciais da GRI nos relatórios das empresas dos setores de petróleo, gás e combustível e de utilidade pública no Brasil. *Revista de Gestão Ambiental e Sustentabilidade - GeAS* Vol. 3, N. 2. Maio./ Agosto. 2014.
46. Wilson, M. (2023) .Corporate sustainability: what is it and where does it come from? *Ivey Business Journal*. Available at: [http://elearning.rnhrealities.com/wp-content/uploads/2012/04/csarticle\\_2.pdf](http://elearning.rnhrealities.com/wp-content/uploads/2012/04/csarticle_2.pdf). [Accessed 07 Jul. 2024]
47. Yousefi, A., Hadi-Vencheh (2016). A. Selecting Six Sigma projects: MCDM or DEA?. *Journal of Modelling in Management* 11(1):309-325. DOI: <http://dx.doi.org/10.1108/JM2-05-2014-0036>.
48. Yu, W. (1992). ELECTRE TRI - Aspects Methodologiques et Guide d'Utilisation. Document du LAMSADE. Paris: Université de Paris-Dauphine.

## **ANALYSIS OF OCCUPATIONAL HEALTH AND SAFETY TRENDS IN BRAZILIAN ECONOMIC SECTORS:**

**Dayanni de Brito da Silva**

*Federal Fluminense University, Brazil  
dayannibrito@id.uff.br*

**Renan Silva Santos**

*Pontifical Catholic University of Rio de Janeiro, Brazil  
renansilvasantos@esp.puc-rio.br*

**Maria de Lurdes Costa Domingos**

*Federal Fluminense University, Brazil  
mlcdomingos53@gmail.com*

### **ABSTRACT**

*The objective of this research is to analyze occupational health and safety (OHS) trends across different economic sectors in Brazil from 2019 to 2021 using data from the Brazilian National Classification of Economic Activities (CNAE). The methodology used involved collecting data from authoritative sources such as the Brazilian Institute of Geography and Statistics (IBGE) and the Ministry of Labor and Employment, followed by advanced statistical analyses to identify patterns and correlations. The results reveal significant variations in accident and severity rates among different CNAE sections, as well as correlations between these safety metrics and economic indicators such as average wages and the number of employees. For instance, the Water and Sewage sector exhibited the highest accident rates, while the Education sector had the lowest. The conclusions drawn indicate that sector-specific differences in OHS are influenced by unique characteristics of each sector, suggesting the need for tailored prevention strategies. These findings provide a concrete basis for formulating targeted policy interventions and sector-specific safety initiatives, aiming to enhance workplace safety standards across Brazil's diverse economic landscape.)*

**Keywords:** *CNAE, Occupational Health and Safety, Workplace Accidents, Economic Sectors, Regulatory Impact*

### **1. INTRODUCTION**

Occupational health and safety (OHS) is a critical concern in the modern workplace, with significant implications for employee well-being, productivity, and overall economic performance (Takala *et al.*, 2014). In Brazil, a country characterized by its diverse and dynamic economy, understanding OHS trends across different sectors is crucial for effective policy-making and resource allocation (Santana *et al.*, 2005). The Brazilian National Classification of Economic Activities (CNAE) provides a standardized framework for categorizing and analyzing different sectors of the economy (Instituto Brasileiro de Geografia e Estatística - IBGE, 2023). This classification system, aligned with the International Standard Industrial Classification (ISIC), allows for detailed examination of industry-specific trends, including those related to workplace safety and health outcomes. Recent years have seen increased attention to OHS across Brazilian industries, driven by both regulatory requirements and a growing awareness of the economic benefits of a safe work environment (Presidência da República, 2011). However, the relationships between economic factors and safety outcomes remain complex and often vary significantly between different sectors (Filgueiras, 2017). The importance of sector-specific OHS analysis has been highlighted in numerous studies. For instance, Shimizu *et al.* (2021) found significant variations in occupational accident risks across

different economic activities in Brazil, emphasizing the need for tailored prevention strategies. Similarly, Kunodzia et al. (2024) demonstrated how sector-specific characteristics influence the effectiveness of OHS management systems. This study aims to provide a comprehensive analysis of OHS trends across CNAE sections in Brazil from 2019 to 2021, a period marked by significant economic fluctuations and regulatory changes. By examining the correlations between economic indicators (such as average wages and number of employees) and safety metrics (including accident rates and severity rates), we seek to:

- 1) Identify sector-specific trends in OHS performance over the three-year period.
- 2) Analyze the relationship between economic factors and safety outcomes across different CNAE sections.
- 3) Provide evidence-based recommendations for policy-makers and industry leaders to enhance OHS standards across Brazil's diverse economic landscape.

Our research builds upon previous studies in the field, such as the work of Garnica and Barriga (2018), who analyzed occupational accidents in the Brazilian construction industry, and Silva and Barreto (2012), who examined the relationship between work conditions and health outcomes across different occupational categories. By expanding the scope to include several CNAE sections and incorporating recent data, our study provides a more comprehensive and up-to-date understanding of OHS trends in Brazil. The remainder of this paper is structured as follows: Section 2 details our methodology, including data sources and analytical techniques. Section 3 presents our results, providing in-depth analysis of OHS trends across CNAE sections. Section 4 discusses the implications of our findings, contextualizing them within the broader literature on OHS and economic development. Finally, Section 5 concludes with a summary of key insights and recommendations for future research and policy directions.

## **2. THEORETICAL BACKGROUND**

### **2.1. Occupational Health and Safety and data-driven decision-making**

Occupational Health and Safety (OHS) is a critical aspect of modern workplace management, focusing on the prevention of work-related injuries, illnesses, and fatalities. It encompasses a wide range of practices, policies, and procedures designed to create and maintain safe and healthy working environments across various industries (Takala et al., 2014). The importance of OHS has grown significantly in recent decades, driven by increased awareness of its impact on employee well-being, productivity, and overall economic performance. In Brazil, as in many other countries, OHS has become a key concern for policymakers, employers, and workers alike. The Brazilian government has implemented various regulatory frameworks to address workplace safety issues, including the National Policy on Occupational Safety and Health (PNSST) established in 2011 (Presidência da República, 2011). This policy aims to promote and protect workers' health, prevent accidents and occupational diseases, and enhance the quality of life in the workplace. However, the implementation and effectiveness of OHS practices can vary significantly across different economic sectors. Factors such as industry-specific risks, technological advancements, economic pressures, and cultural attitudes towards safety all play a role in shaping OHS outcomes (Filgueiras, 2017). For instance, industries like construction and manufacturing often face higher risks of physical injuries, while service-oriented sectors may deal more with issues related to ergonomics and psychological well-being. The complex nature of OHS challenges necessitates a multidisciplinary approach, integrating knowledge from fields such as engineering, medicine, psychology, and management. This holistic perspective is crucial for developing comprehensive strategies that address both the physical and psychosocial aspects of workplace safety and health. In this vein, the field of Occupational Health and Safety (OHS) has increasingly recognized the critical importance of data-driven decision-making.

In an era where information is abundant, leveraging data effectively can lead to more informed policies, targeted interventions, and ultimately, safer workplaces (Jebb et al., 2017). Data-driven approaches in OHS offer several key advantages:

- 1) **Evidence-based Policy Making:** Data provides an objective foundation for developing and implementing OHS policies. By analyzing trends and patterns in workplace accidents, illnesses, and near-misses, policymakers can craft regulations that address the most pressing safety concerns across different industries (Haslam et al., 2016).
- 2) **Proactive Risk Management:** Rather than reacting to incidents after they occur, data analysis enables organizations to identify potential hazards and implement preventive measures. Predictive analytics, for instance, can help forecast high-risk periods or areas, allowing for preemptive action (Sarkar et al., 2019).
- 3) **Resource Optimization:** With limited resources available for OHS initiatives, data-driven insights can help prioritize interventions where they are most needed and likely to have the greatest impact. This ensures efficient allocation of both financial and human resources (Badri et al., 2018).
- 4) **Performance Benchmarking:** Data allows companies to compare their safety performance against industry standards or similar organizations, fostering a culture of continuous improvement and healthy competition in safety standards (Podgórski, 2015).
- 5) **Customized Interventions:** Different sectors and even individual workplaces have unique risk profiles. Data analysis can reveal these specific patterns, enabling the development of tailored safety strategies that are more effective than one-size-fits-all approaches (Yorio et al., 2015).
- 6) **Impact Assessment:** Longitudinal data collection and analysis provide a means to evaluate the effectiveness of OHS interventions over time, allowing for iterative improvements in safety programs (Robson et al., 2007).

Nevertheless, the journey towards fully data-driven OHS decision-making faces several challenges. These include data quality and consistency issues, privacy concerns, the need for data literacy among OHS professionals, and the complexity of integrating diverse data sources (Sinelnikov et al., 2015). To address these challenges and fully realize the potential of data-driven OHS, several strategies are being pursued:

- 1) **Development of Standardized Metrics:** Efforts are being made to establish common OHS indicators across industries, facilitating benchmarking and trend analysis (Sinelnikov et al., 2015).
- 2) **Investment in Data Infrastructure:** Organizations are increasingly investing in robust data collection and management systems to ensure high-quality, timely OHS data (Hallowell et al., 2020).
- 3) **Advanced Analytics:** The application of machine learning and AI technologies to OHS data is opening new possibilities for predictive risk assessment and automated safety monitoring (Tixier et al., 2016).
- 4) **Collaborative Data Sharing:** Initiatives to share anonymized OHS data across organizations or industries are emerging, allowing for more comprehensive analysis and insights (Sinelnikov et al., 2015).

As Reis et al. (2021) highlighted in their review of data mining in OHS, the integration of diverse data sources and the application of advanced analytical techniques present significant opportunities for a more comprehensive and nuanced understanding of workplace safety trends.

## 2.2. Management of Occupational Health and Safety

Effective management of occupational health and safety is crucial for reducing workplace risks and promoting employee well-being. OHS management encompasses a range of strategies, systems, and practices designed to identify, assess, and control workplace hazards. Key components of OHS management include:

- 1) **OHS Management Systems (OHSMS):** These are systematic approaches to managing workplace safety, often based on international standards such as ISO 45001. Kunodzia et al. (2024) highlighted the importance of OHSMS in the construction industry, emphasizing how sector-specific characteristics influence the effectiveness of these systems.
- 2) **Risk Assessment and Control:** This involves identifying potential hazards, evaluating their likelihood and potential impact, and implementing measures to eliminate or mitigate risks. Garnica and Barriga (2018) explored barriers to effective risk assessment in small Brazilian enterprises, highlighting the need for tailored approaches for different business sizes and sectors.
- 3) **Training and Education:** Ongoing safety training for employees is essential for creating a culture of safety awareness and ensuring compliance with OHS procedures.
- 4) **Incident Investigation and Reporting:** Thorough investigation of accidents and near-misses, coupled with robust reporting systems, is crucial for preventing future incidents and continuously improving safety practices.
- 5) **Health Promotion and Well-being Programs:** Many organizations are expanding their OHS efforts beyond traditional safety concerns to include initiatives promoting overall employee health and well-being.
- 6) **Performance Monitoring and Continuous Improvement:** Regular evaluation of OHS performance using key metrics and benchmarking against industry standards is essential for identifying areas for improvement.

The effectiveness of OHS management can vary significantly across different sectors of the Brazilian economy. For instance, Silva and Barreto (2012) found that stressful working conditions in the financial services sector were associated with poor self-rated health among employees, highlighting the need for sector-specific OHS strategies that address both physical and psychosocial risks. Moreover, the integration of OHS management with broader business strategies is increasingly recognized as crucial for sustainable organizational success. This involves not only compliance with regulatory requirements but also proactive approaches to creating safer, healthier workplaces that contribute to improved productivity and employee satisfaction (Abdelrahim et al., 2023). Emerging trends in OHS management include the use of digital technologies for real-time risk monitoring, the application of big data analytics for predictive risk assessment, and the adoption of participatory approaches that involve workers in the design and implementation of safety initiatives (Uhrenholdt Madsen et al., 2022). In conclusion, effective management of occupational health and safety requires a comprehensive, data-driven approach that takes into account the unique characteristics of different economic sectors. By leveraging available data, implementing robust management systems, and fostering a culture of safety, organizations can work towards reducing workplace accidents and illnesses, ultimately contributing to the overall well-being of workers and the productivity of the Brazilian economy.

## 3. METHODOLOGY

In this section, methodology used in the work is detailed. It is comprised by data collection, variable selection, analysis and visualization.

### 3.1. Data collection

Our analysis utilizes data from multiple authoritative sources to ensure a comprehensive and accurate representation of OHS trends across Brazilian economic sectors:

- 1) The Brazilian Institute of Geography and Statistics (IBGE) (Instituto Brasileiro de Geografia e Estatística (IBGE), 2023): IBGE provides supplementary economic data and CNAE classification updates.
- 2) The Ministry of Work and Employment (Ministério do Trabalho e Emprego, 2023): This source offers additional data on work-related benefit claims, providing another perspective on occupational injuries and illnesses.

The integration of these diverse data sources allows for a more nuanced analysis, as recommended by Reis et al. (2021) in their review of data mining for OHS.

### 3.2. Variables and measures

For each CNAE section and year (2019-2021), we extracted and analyzed the following key variables:

- Number of companies
- Average wage (in Brazilian Reais, not adjusted for inflation)
- Number of employees
- Accident rate (per 1,000 employees)
- Severity rate (days lost per million hours worked)
- Fatal accident rate (per 100,000 employees)
- Occupational disease rate (per 10,000 employees)

These variables were chosen based on their relevance in previous OHS studies (Shimizu et al., 2021; Takala et al., 2014) and their ability to provide a comprehensive picture of both safety outcomes and economic factors.

### 3.3. Analytical approach

Our analytical approach combines descriptive statistics, data analysis, and advanced data visualization techniques:

#### 3.3.1. Descriptive Statistics

We employed descriptive statistics to summarize trends in each variable across years and CNAE sections. This includes measures of central tendency (mean, median) and dispersion (standard deviation, range) for each variable. Time series analysis was used to track changes in accident rates, severity rates, and other safety metrics over the three-year period, following methods outlined by Shumway and Stoffer (2017).

#### 3.3.2. Comparative Analysis

We developed a composite 'safety score' to rank sectors based on their combination of wage levels and accident rates, inspired by the work of Garnica and Barriga (2018) on risk assessment in the construction industry. This score was calculated as:

$$Well - being_i = \frac{Wage_i}{Accident Rate_i} \quad (2)$$

#### 3.3.3. Data Visualization

We utilized advanced data visualization techniques to represent complex relationships and trends in the data. This includes heat maps for sectoral comparisons, scatter plots for exploring

relationships between variables, and time series plots for tracking changes over the study period. These visualizations were created using the seaborn and matplotlib libraries in Python (Hunter, 2007; Waskom *et al.*, 2017).

### 3.4. Software and Tools

Data processing and analysis were conducted using Python 3.8, with the following key libraries:

- pandas for data manipulation (McKinney *et al.*, 2010)
- seaborn and matplotlib for data visualization (Hunter, 2007; Waskom *et al.*, 2017)

This combination of tools allows for robust, reproducible analysis, as advocated by ? in their guide to best practices in scientific computing.

## 4. RESULTS

This chapter presents the main results and key findings for the analysis performed.

### 4.1. Overview

Our analysis revealed significant variations in accident rates and severity rates across different CNAE sections. Table 1 presents summary statistics for these key safety metrics across all sectors for the year 2021.

CNAE Group	Incidence (per 1000 workers)	Incidence of Work Diseases (per 1000 workers)	Incidence of typical accidents (per 1000 workers)	Incidence of Temporary incapacitation (per 1000 workers)	Mortality (per 100000 workers)	Lethality (per 100000 workers)	Accidents for workers between 16 - 34 (per 1000 workers)	Average salary (BRL)
A	13.60	0.15	11.19	12.12	20.88	13.19	45.99	2132.63
B	20.66	0.66	15.76	13.99	31.54	16.10	40.53	5359.85
C	22.53	0.60	16.33	18.40	13.31	5.79	49.38	3247.71
D	14.20	0.65	9.25	10.42	12.82	8.14	33.87	7547.91
E	37.21	0.42	27.74	30.16	23.28	6.10	46.52	3512.65
F	17.65	0.26	12.84	14.85	16.72	9.87	43.23	2440.73
G	10.01	0.16	6.41	8.93	8.10	8.28	57.86	2122.28
H	17.00	0.47	11.43	14.14	14.82	12.69	38.73	2920.46
I	9.63	0.16	6.25	8.62	4.15	4.66	47.31	1538.78
J	6.24	0.19	3.71	5.81	7.36	11.28	52.06	5424.40
K	6.26	0.97	2.49	5.38	23.09	38.45	46.32	6908.00
L	7.18	0.10	4.64	6.63	9.53	9.72	45.69	2590.73
M	6.35	0.14	3.63	5.44	5.00	6.12	53.80	3537.72
N	8.84	0.14	4.81	7.84	7.68	10.21	49.76	1908.28
O	12.28	0.50	9.53	9.95	9.06	10.89	27.97	4684.64
P	5.18	0.15	3.08	4.43	2.85	6.58	39.16	3900.66
Q	18.79	0.71	13.00	11.54	4.69	2.51	38.52	3018.83
R	10.57	0.24	7.20	9.74	8.77	14.94	51.59	2439.62
S	8.08	0.23	4.99	6.97	5.70	12.23	46.76	2254.90
U	5.69	0.00	3.62	5.52	25.48	71.43	24.83	6279.29

Table 1: Summary Statistics of Safety Metrics by CNAE Section  
(Source: The authors)

Notable findings include:

- The Water and Sewage sector (Section E) shows higher than average accident rates, with a mean of 37.21 accidents per 1,000 employees across the years, compared to the overall average of 12.90.
- The education sector (Section P) demonstrated the lowest accident rates, with only 5.18 accidents per 1,000 employees.
- Temporary incapacitation is above average in sectors like Extrativist Industries (Section B), Transformation Industries (Section C), Electricity (Section D), Water and Sewage (Section E), Construction (Section F), Transportation and Logistics (Section H) and Health (Section Q).

These findings align with previous sector-specific studies, such as (Kunodzia *et al.*, 2024) work on the construction industry and (Mustard and Yanar, 2023; Santana *et al.*, 2005) analysis of occupational categories.

#### 4.2. Temporal trends

Figure 1 illustrates the overall trends in accident rates and rates from 2019 to 2021.

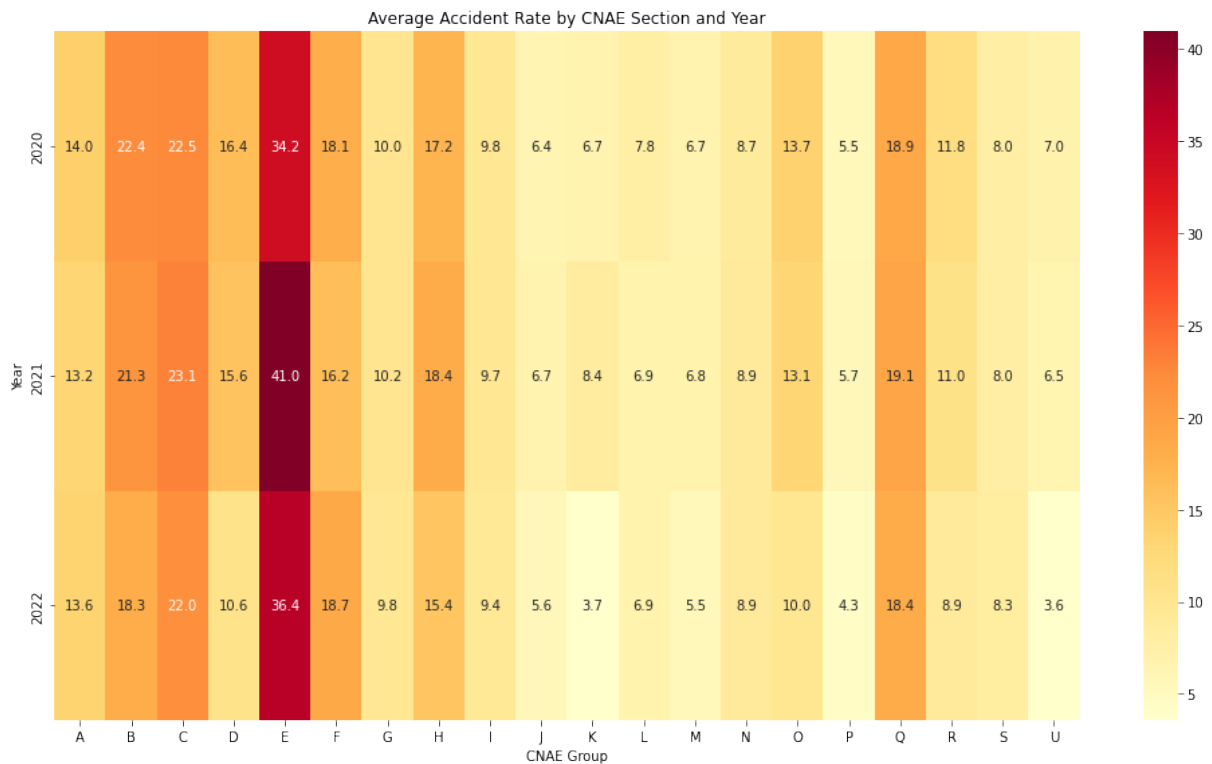

Figure 1: Heatmap of Accident Rates by CNAE Section(2019-2021)  
(Source: The authors)

Key observations include:

- A general downward trend in accident rates across most sectors, with an overall reduction of 15.3
- Some sectors, like Financial Services (Section K) and International Organisms (Section U) show an abrupt change in accident rates



### 4.3. Relationships between economic and safety factors

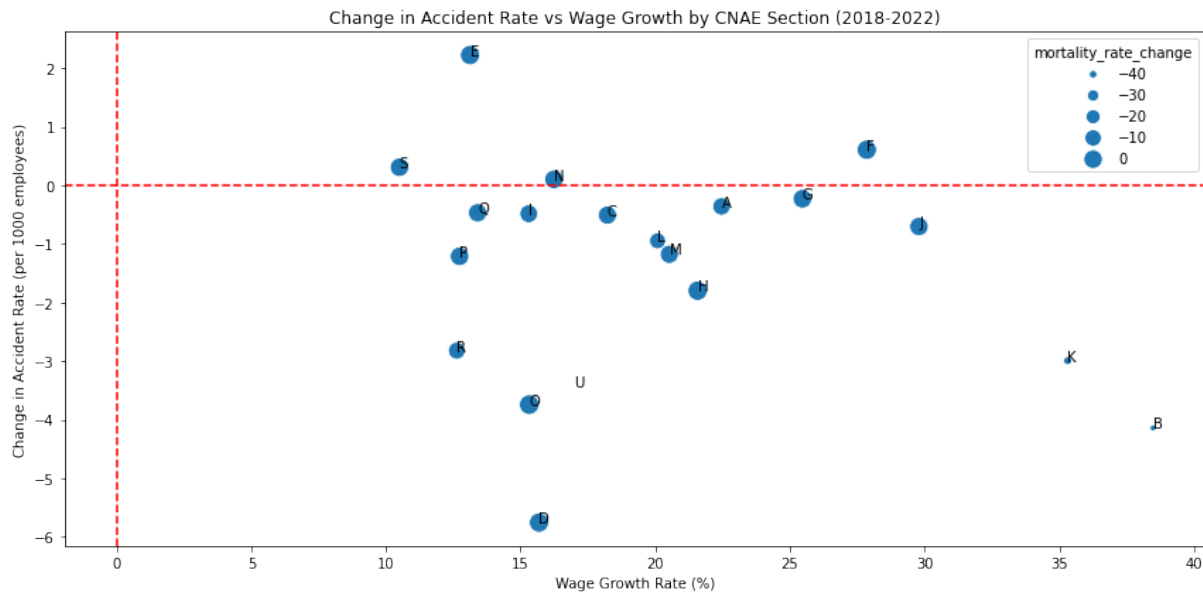

Figure 2: Scatterplot of mortality, accident and wage change in the period analyzed (Source: The authors)

Notable findings include:

- Financial services (Section K) and Extractivist Industries (Section B) showed a high drop in mortality rates in the period
- Overall, all the sectors presented a growth (not inflation-adjusted) in wages
- Only 4 sectors showed a growth in accident rates

### 4.4. Comparison and benchmarking

In order to evaluate and compare the sectors, we propose a “well-being” score for the sectors, comprised by the average wage and the incidence of accidents, as defined in equation (2) The score for the five top ranked sectors is as follows:

CNAE Group	Incidence (per thousand workers)	Average salary (R\$)	safety_score
K	3.70	8039.19	2174.89
U	3.57	6851.77	1919.26
J	5.65	6266.42	1109.43
P	4.33	4229.79	977.34
D	10.60	8312.01	784.15

Table 2: Well-being index for the top 5 sectors (Source: The authors)

## 5. CONCLUSION

This work leveraged the use of official, available data to analyze patterns across different economic sectors in Brazil. This allowed to identify sectors that are more advanced in terms of the needed balance of economic well-being of its workers and good occupational health and safety practices. These insights can inform targeted policy interventions and industry-specific safety initiatives.

By continuing to monitor and analyze these trends, policymakers and industry leaders can work towards improving workplace safety standards across all sectors of the Brazilian economy, ultimately enhancing both worker well-being and economic productivity. Future research could delve deeper into the causal factors behind these trends, potentially incorporating qualitative data on safety practices and regulatory enforcement across different sectors. Also, a survey with representatives, both from the managerial and operational perspective, could offer valuable insights. Lastly, incorporation of other data to develop more robust benchmarking metrics could help in policymaking.

**ACKNOWLEDGEMENT:** *This study was financed in part by the Coordenação de Aperfeiçoamento de Pessoal de Nível Superior – Brasil (CAPES) – Finance Code 001.*

## LITERATURE:

1. Abdelrahim, R., Otitolaiye, V., Omer, F., Abdelbasit, Z. and Balida, D.A.R. (2023), “Occupational Safety and Health Management in Selected Industrial Sectors in Sudan”, *International Journal of Occupational Safety and Health*, Vol. 13 No. 3, pp. 361–374, doi: 10.3126/ijosh.v13i3.46418.
2. Badri, A., Boudreau-Trudel, B. and Souissi, A.S. (2018), “Occupational health and safety in the industry 4.0 era: A cause for major concern?”, *Saf. Sci.*, Elsevier BV, Vol. 109, pp. 403–411.
3. Filgueiras, V.A. (2017), “Saúde e segurança do trabalho no Brasil”, *Saúde e Segurança Do Trabalho No Brasil. Brasília*, pp. 19–78.
4. Garnica, G.B. and Barriga, G.D.C. (2018), “Barriers to occupational health and safety management in small Brazilian enterprises”, *Production*, Vol. 28 No. 0, doi: 10.1590/0103-6513.20170046.
5. Hallowell, M.R., Bhandari, S. and Alruqi, W. (2020), “Methods of safety prediction: analysis and integration of risk assessment, leading indicators, precursor analysis, and safety climate”, *Constr. Manage. Econ.*, Informa UK Limited, Vol. 38 No. 4, pp. 308–321.
6. Haslam, C., O’Hara, J., Kazi, A., Twumasi, R. and Haslam, R. (2016), “Proactive occupational safety and health management: Promoting good health and good business”, *Saf. Sci.*, Elsevier BV, Vol. 81, pp. 99–108.
7. Hunter, J.D. (2007), “Matplotlib: A 2D graphics environment”, *Computing in Science & Engineering*, IEEE, Vol. 9 No. 3, pp. 90–95.
8. Instituto Brasileiro de Geografia e Estatística (IBGE). (2023), *Classificação Nacional de Atividades Econômicas (CNAE)*.
9. Jebb, A.T., Parrigon, S. and Woo, S.E. (2017), “Exploratory data analysis as a foundation of inductive research”, *Hum. Resour. Manag. Rev.*, Elsevier BV, Vol. 27 No. 2, pp. 265–276.
10. Kunodzia, R., Bikitsha, L.S. and Haldenwang, R. (2024), “Perceived Factors Affecting the Implementation of Occupational Health and Safety Management Systems in the South African Construction Industry”, *Safety*, Vol. 10 No. 1, p. 5, doi: 10.3390/safety10010005.
11. McKinney, W. and others. (2010), “Data structures for statistical computing in python”, *Proceedings of the 9th Python in Science Conference*, Vol. 445, pp. 51–56.
12. Ministério do Trabalho e Emprego. (2023), “Bases de Dados e Estatísticas”.
13. Mustard, C.A. and Yanar, B. (2023), “Estimating the financial benefits of employers’ occupational health and safety expenditures”, *Safety Science*, Vol. 159, p. 106008, doi: 10.1016/j.ssci.2022.106008.
14. Podgórski, D. (2015), “Measuring operational performance of OSH management system – A demonstration of AHP-based selection of leading key performance indicators”, *Saf. Sci.*, Elsevier BV, Vol. 73, pp. 146–166.

15. Presidência da República. (2011), “Política Nacional de Segurança e Saúde no Trabalho - PNSST”, *Diário Oficial Da União*.
16. Reis, B.L. dos, Rosa, A.C.F. da, Machado, A. de A., Wencel, S.L.S.S., Leal, G.C.L., Galdamez, E.V.C. and Souza, R.C.T. de. (2021), “Data mining in occupational safety and health: a systematic mapping and roadmap”, *Production*, Vol. 31, doi: 10.1590/0103-6513.20210048.
17. Robson, L.S., Clarke, J.A., Cullen, K., Bielecky, A., Severin, C., Bigelow, P.L., Irvin, E., *et al.* (2007), “The effectiveness of occupational health and safety management system interventions: A systematic review”, *Saf. Sci.*, Elsevier BV, Vol. 45 No. 3, pp. 329–353.
18. Santana, V., Nobre, L. and Waldvogel, B.C. (2005), “Acidentes de trabalho no Brasil entre 1994 e 2004: uma revisão”, *Ciência & Saúde Coletiva*, Vol. 10 No. 4, pp. 841–855, doi: 10.1590/S1413-81232005000400009.
19. Sarkar, S., Vinay, S., Raj, R. and Maiti J and Mitra, P. (2019), “Application of optimized machine learning techniques for prediction of occupational accidents”, *Comput. Oper. Res.*, Elsevier BV, Vol. 106, pp. 210–224.
20. Shimizu, H.E., Bezerra, J.C., Arantes, L.J., Merchán-Hamann, E. and Ramalho, W. (2021), “Analysis of work-related accidents and ill-health in Brazil since the introduction of the accident prevention factor”, *BMC Public Health*, Vol. 21 No. 1, p. 725, doi: 10.1186/s12889-021-10706-y.
21. Shumway, R.H. and Stoffer, D.S. (2017), *Time Series Analysis and Its Applications*, Springer International Publishing, Cham, doi: 10.1007/978-3-319-52452-8.
22. Silva, L.S. and Barreto, S.M. (2012), “Stressful working conditions and poor self-rated health among financial services employees”, *Revista de Saúde Pública*, Vol. 46 No. 3, pp. 407–416, doi: 10.1590/S0034-89102012005000023.
23. Sinelnikov, S., Inouye, J. and Kerper, S. (2015), “Using leading indicators to measure occupational health and safety performance”, *Saf. Sci.*, Elsevier BV, Vol. 72, pp. 240–248.
24. Takala, J., Hämäläinen, P., Saarela, K.L., Yun, L.Y., Manickam, K., Jin, T.W., Heng, P., *et al.* (2014), “Global Estimates of the Burden of Injury and Illness at Work in 2012”, *Journal of Occupational and Environmental Hygiene*, Vol. 11 No. 5, pp. 326–337, doi: 10.1080/15459624.2013.863131.
25. Tixier, A.J.-P., Hallowell, M.R., Rajagopalan, B. and Bowman, D. (2016), “Application of machine learning to construction injury prediction”, *Autom. Constr.*, Elsevier BV, Vol. 69, pp. 102–114.
26. Uhrenholdt Madsen, C., Vester Thorsen, S., Hasle, P., Leonhardt Laursen, L. and Dyreborg, J. (2022), “Differences in occupational health and safety efforts between adopters and non-adopters of certified occupational health and safety management systems”, *Safety Science*, Vol. 152, p. 105794, doi: 10.1016/j.ssci.2022.105794.
27. Waskom, M., Botvinnik, O., O’Kane, D., Hobson, P., Lukauskas, S., Gemperline, D.C., Augspurger, T., *et al.* (2017), “mwaskom/seaborn: v0.8.1 (September 2017)”, Zenodo, September, doi: 10.5281/zenodo.883859.
28. Yorio, P.L., Willmer, D.R. and Moore, S.M. (2015), “Health and safety management systems through a multilevel and strategic management perspective: Theoretical and empirical considerations”, *Saf. Sci.*, Elsevier BV, Vol. 72, pp. 221–228.

# CYBER INSURANCE IN BRAZIL: ANALYSIS OF BENEFITS AND CHALLENGES

**Karla Siqueira de Oliveira**

*Universidade Federal Fluminense, Brazil*  
*kasiqueira@id.uff.br*

**Carolina Cardoso Novo**

*Universidade Federal Fluminense, Brazil*  
*carolinanovo@id.uff.br*

**Mirian Picinini Mexas**

*Universidade Federal Fluminense, Brazil*  
*mirian\_mexas@id.uff.br*

**Lidia Angulo Meza**

*Universidade Federal Fluminense, Brazil*  
*lidiaangulomeza@id.uff.br*

## **ABSTRACT**

*The digital evolution of recent decades, in addition to promoting technological innovations, has brought several significant threats, such as service interruptions and data theft. However, despite recent studies addressing this issue, due to the dynamic nature of these threats, the use of cyber insurance as a protection mechanism is still an increasingly developing field. This study aims to evaluate the importance of cyber insurance, highlighting its benefits and challenges associated with its adoption. An empirical investigation was carried out considering the context of the Brazilian insurance market. Data collection involved the application of a questionnaire that gathered perceptions from 139 participants, including specialists in the sector and individuals with no prior knowledge of the subject. The results indicate that, despite being a new market impacted by the underreporting of incidents, cyber insurance plays a crucial role in mitigating cyber risks in various segments of society. We recommend analyzing how advanced technologies can innovate and create flexible policies to meet the specific needs of companies. The limitations of the study include the continuous and rapid evolution of cyber threats, which may influence the observations made. As a contribution, the study seeks to encourage awareness and information on strategies to strengthen digital security, especially considering the context of developing countries.*

**Keywords:** *cyber insurance, cyber risk, benefits, challenges*

## **1. INTRODUCTION**

A technological revolution is restructuring society by introducing new economic and social arrangements while fostering opportunities for innovation and service enhancement (Markopoulou, 2021). However, despite the benefits generated, the interconnectedness and dependence on digital systems present significant challenges (Barreto et al., 2023; Pal et al., 2021). In 2013, a security breach at the American company Target resulted in financial losses exceeding 290 million dollars (Ogbanufe et al., 2021). Nearly five years later, the data-wiping malware attack known as NotPetya had a global impact, affecting various sectors, including finance, transportation, energy, commerce, and government (Tatar et al., 2021). Examples of such attacks reinforce the concern of companies worldwide regarding cyber threats (Biswas et al., 2024). Furthermore, the vast amount of data circulating through electronic interfaces is recognized as highly valuable assets, making them targets for malicious individuals.

In response, governments are enacting data protection regulations, including imposing sanctions and fines on organizations in case of breaches (Cremer et al., 2022; Skeoch, 2022). In this scenario, cyber insurance emerges as a risk management tool capable of minimizing the financial impact of cyber risks (Cremer et al., 2022; Liu et al., 2021; Shackelford, 2012). According to Watson et al. (2022), cyber insurance is a financial tool companies use to transfer losses caused by cyber risks. There is no consensus in the literature about the definition of cyber risks. In He et al. (2024), various definitions and characteristics of cyber risks are presented from an interdisciplinary approach. Due to the constantly changing Information and Communication Technology landscape, several difficulties arise in modeling cyber risk (Dacorogna and Kratz, 2023), making it a developing topic (Branley-Bell et al., 2021; Wang et al., 2021; Biener et al., 2015). Rangu et al. (2024), focusing on developed countries, conducted an empirical investigation to identify the role of cyber insurance and its benefits and limitations. In contrast, few studies address the topic considering the context in developing countries (Hamid et al., 2022). Kuru and Bayraktar (2017) contributed to changing this scenario by highlighting the relationship between cyber insurance and social welfare through a study comparing the situation in three countries. Given the above, this research aims to answer the following question: what are the main benefits and challenges encountered in implementing cyber insurance? The expansion of the insurance sector contributes to the economic growth of a country (López and Cortés, 2022). Understanding the characteristics of cyber insurance represents a significant opportunity to stimulate the development of the insurance market, both in developing economies (Hamid et al., 2022) and in developing countries where the market is at a saturation stage (Dacorogna and Kratz, 2023). In this context, it becomes imperative that insurers are adequately prepared to offer protection against any risk, seeking viable alternatives for risk acceptance, thereby preventing other segments from operating in the insurance sector (Sibindi, 2015). This study aims to evaluate the importance of cyber insurance, highlighting the benefits and challenges associated with its adoption. To achieve this objective, field research was conducted, considering both experts involved in the sector and individuals without knowledge of the subject, focusing on the Brazilian context. This investigation is important for academic debate and offers useful guidance for business managers. Additionally, it promotes a greater understanding of the topic in society. The article is organized as follows: section 2 presents a brief literature review; section 3 describes the research method; section 4 highlights the results and discussion; and section 5 provides the conclusions.

## **2. A BRIEF LITERATURE REVIEW**

The first insurance coverage focused on digital support emerged in the 1990s with the advent of the Internet (Baker and Shortland, 2023). Since then, according to Marotta et al. (2017), cyber insurance has become essential for ensuring cybersecurity and protecting individuals and organizations against digital threats. According to Mukhopadhyay et al. (2013), cyber insurance represents the transfer of risks characterized by low frequency and high impact. Kuru and Bayraktar (2017) describe cyber insurance as an alternative tool to enhance digital security systems. Shackelford (2012) emphasizes that business managers, in addition to investing in cybersecurity through their strategies, must also decide whether to invest in cyber insurance. Due to the constant technological evolution, Biener et al. (2015) highlight the lack of consensus on the terms and definitions used and the frequent changes in insurance coverage. Niyato et al. (2017) identify five important processes involved in cyber insurance: (1) risk definition; (2) risk assessment; (3) data collection; (4) policy proposal; and (5) contract establishment. The adoption of cyber insurance brings various benefits, such as the updating of protection models and the development of a company's financial sustainability, contributing to the overall well-being of society (Kshetri, 2018; Liu et al., 2022).

However, the insurance market faces challenges, such as a lack of incident data and difficulty determining insurance premiums (Hamid et al., 2022). Moreover, according to Sangari et al. (2022), the underreporting of cyber incidents is an obstacle, as many companies avoid disclosing malicious attacks due to fears of the impact on their image, reputation, and corporate finances. Wrede et al. (2020) note that the lack of clarity about policy coverage exclusions and inclusions is a challenge for the consolidation of cyber insurance. According to the authors, acts of war and terrorism are the most common exclusions in contracts. Recently, Nobanee et al. (2023) provided a comprehensive overview of cyber insurance research. Focusing specifically on the losses incurred from the NotPetya attack on a large American company, Tatar et al. (2021) examined the challenges of insurance coverage for cyber risks. Hoppe et al. (2021) conducted a study to gather information on the current state of cyber risk management in small and medium-sized enterprises. Franke (2017) points out that there is little empirical research on cyber insurance. In this regard, the author developed a study to characterize the insurance market in Sweden. In contrast, Hamid et al. (2022) conducted research to highlight the reasons for the low adoption of cyber insurance in Malaysia. The literature demonstrates that despite recent efforts to advance the theoretical and empirical understanding of cyber insurance, further research is still needed to contribute to developing knowledge in this area.

### **3. METHODOLOGY**

A research instrument was developed and applied for data collection, consisting of a questionnaire containing both closed and open questions, based on the analysis of the results of the systematic literature review carried out in Oliveira, Méxas and Novo (2023). The target audience ranged from individuals with little knowledge of the subject to experts who work or have worked in the field of cyber insurance, as well as professionals without practical experience but with theoretical knowledge in this area. The responses were collected using a Likert scale, which measures the degree of agreement of the participants: (1) agree; (2) strongly agree; (3) neither agree nor disagree; (4) disagree; (5) strongly disagree. In an initial phase, a pre-test was conducted with 12 experts in the field of cyber insurance from 21/10/2023 to 31/10/2023. However, it was unnecessary to reformulate any of the statements based on the results obtained during this evaluation phase. This suggests a good initial validation of the questionnaire, indicating that the questions were adequately understood by the experts and that the research instrument was effective in capturing the desired information. The quantitative data from the questionnaires were analyzed and processed using basic statistical techniques appropriate for each case, with the assistance of Excel to facilitate the analysis. The qualitative data were analyzed using content analysis techniques, and the results were compared with the findings from the literature. According to Bardin (2011), content analysis employs various communication analysis techniques to infer relevant information about the development or reception of the examined messages, utilizing systematic methods and discriminatory indicators. It is important to note that the questionnaire was initially drafted in a Word document and subsequently transferred to Google Forms. The survey was distributed via a link provided by the tool itself, and it was widely disseminated across various platforms, including email and LinkedIn, targeting professionals in the field of cyber insurance. Additionally, the survey was promoted in several WhatsApp groups and on Instagram to reach a broader and more diverse audience. This multi-platform approach helped maximize participation and obtain a variety of perspectives on the topic addressed in the questionnaire.

### **4. RESULTS AND DISCUSSION**

The questionnaire responses were collected between 10/31/2023 and 11/26/2023. These responses were analyzed comprehensively and anonymously, thus ensuring the confidentiality of participants' information. This approach aims to ensure data integrity and promote a trusting

environment, allowing for an impartial and objective interpretation of the results obtained. The field research gathered the participation of 139 respondents, providing a variety of opinions regarding the central theme of the study. The survey was structured in two distinct parts. The first part addressed the profile of the respondents, exploring aspects such as age group, gender, and level of knowledge about cyber insurance. The second part involved a survey based on a Likert scale to evaluate the participants' perceptions of the benefits and challenges associated with adopting cyber insurance, according to Tables 1 and 2. The analysis of the respondents' profiles reveals that 25.18% are between 19 and 25 years old, 28.06% are in the age group of 26 to 35 years, 46.04% are more mature participants (36+ years), and 0.72% are under 18 years old. The majority of participants are male (57%). Of the total, 5.76% have professional experience in the field, while 13.67% are not or have never been professionals in the field but have knowledge about the subject. Additionally, 38.13% of the participants revealed that they do not have substantial knowledge about the topic. Table 1 presents the field research results on the benefits of implementing cyber insurance.

Statements	Scale in %				
	Agree	Strongly agree	Neither agree nor disagree	Disagree	Strongly disagree
Factors involving risk transfer to the insurer	<b>70.5%</b>	20.1%	5.0%	4.3%	0.0%
It can cover costs related to investigating the cause of an incident and the costs of forensic computing experts to help assess the extent of any breach	<b>59.0%</b>	28.8%	11.5%	0.0%	0.7%
It encourages cybersecurity improvement, aiming at reducing the insurance premium, and facilitates risk diversification	<b>55.4%</b>	18.7%	17.3%	8.6%	0.0%
It provides protection and social well-being, in addition to helping notify customers about data breaches	<b>46.0%</b>	29.5%	13.7%	10.8%	0.0%
Manages public relations and communication with the media: image restoration	<b>53.2%</b>	17.3%	17.3%	11.5%	0.7%
Deals with the restoration of services infected by the cyber attack	<b>56.1%</b>	25.2%	11.5%	6.5%	0.7%

*Table 1: Respondents' opinions on the benefits of adopting cyber insurance*

Table 1 shows that about 70.5% agree, 20.1% strongly agree, and only 4.3% disagree that the factors involving risk transfer to the insurer are benefits of implementing cyber insurance. The literature reiterates these aspects, as Uganbayar et al. (2018) report, that this type of insurance mitigates the expected damage caused by cyber-attacks by transferring these risks to an insurer. According to Chase et al. (2017), cyber insurance can provide coverage for privacy breaches, offering protection to the industry. Additionally, Tonn et al. (2019) state that cyber insurance offers security and privacy liability for your company towards third parties. Watson et al. (2022) affirm that cyber insurance narrows the gap between cyber risk and technical security countermeasures to an acceptable level, minimizing financial impacts. It is inferred that 59% of respondents agree and 28.8% strongly agree that cyber insurance benefits include the possibility of covering costs related to investigating the cause of an incident and the costs of forensic computing experts to help assess the extent of any breach. This is corroborated by Skeoch (2022), who states that insurance plays an important role in contributing to forensic investigation, identifying the impact of the data breach on the company, and assisting in

vulnerability correction and system restitution. It is affirmed that approximately 55% of respondents agree that there is an incentive to improve cybersecurity, aiming to reduce the insurance premium and facilitate risk diversification. These aspects are in harmony with the researched articles, as authors Liu et al. (2022) certify that cyber insurance stimulates investment in cybersecurity, thus recognizing the quality of protection and replacing outdated models. Additionally, for Piromsopa et al. (2017), insurance is an effective solution for many risk-related challenges, enabling diversification. It is inferred that, aligned with the studied articles, 46% of respondents agree and 29.5% strongly agree that cyber insurance assists in notifying customers during a data breach and provides protection and social well-being. According to authors Liu et al. (2022), cyber insurance promotes well-being throughout society by encouraging investment in cybersecurity. According to Herr (2021), cyber insurance also covers the notification of data breaches as required by the GDPR (General Data Protection Regulation). It is also noted that, according to Strupczewski (2018), cyber insurance offers the benefit of covering public relations expenses to manage reputational risk. This aspect is in harmony with the questionnaire results, as although 17.3% of respondents neither agree nor disagree, about 53.2% agree, and 17.3% strongly agree with this assertion. About 56% agree that the restoration of services affected by malicious attacks is a benefit related to cyber insurance. Branley-Bell et al. (2022) validate this aspect by stating that insurance addresses the interruption of system operations and restores these services. After selecting an option on the scale for each presented assertion, respondents were asked if they had any additional comments on the benefits of adopting cyber insurance or if they wished to add any observations not previously mentioned. The comments were analyzed, and the most relevant ones are described below. Respondent 1 mentions that cyber insurance deals with high-severity claims in a high-frequency scenario. Additionally, the lack of insurers specializing in cyber insurance makes it difficult for companies to seek adequate protection against cyber threats. Respondent 4 highlights some obstacles companies face in risk assessment, selection of appropriate policies, and compliance with constantly evolving regulatory requirements. This underscores the need to mitigate these challenges through integrated cooperation between insurers and cybersecurity experts. Table 2 shows the respondents' views on the challenges of cyber insurance.

Statements	Scale in %				
	Agree	Strongly agree	Neither agree nor disagree	Disagree	Strongly disagree
Factors involving the transfer of risk to the insurer	<b>50.4%</b>	20.9%	22.3%	5.8%	0.7%
Factors involving the underwriting process (risk assessment)	<b>55.4%</b>	20.1%	17.3%	6.5%	0.7%
Factors involving management	<b>55.4%</b>	22.3%	18.7%	3.6%	0.0%
Factors involving risk management	<b>56.1%</b>	16.5%	23.7%	2.9%	0.7%
Factors involving indemnification	<b>37.4%</b>	12.2%	28.1%	19.4%	2.9%
Underreporting of cyber incidents and challenges associated with technological disruption	<b>54.7%</b>	18.0%	21.6%	5.8%	0.0%
Stigmas of social insurance: lack of awareness and negative perceptions of the insurance concept	<b>61.9%</b>	18.7%	12.9%	5.0%	1.4%
Various factors	<b>47.5%</b>	15.8%	25.9%	10.1%	0.7%

*Table 2: Respondents' opinions on the challenges to adopting cyber insurance*

According to Table 2, regarding factors involving the transfer of risk to the insurer, 50.4% of respondents agree, and 20.9% strongly agree that these are challenges related to implementing cyber insurance, totaling 71.3% agreement.



This is corroborated by Hamid et al. (2022), who state that cyber insurance generally adds additional services (such as forensic services) to coverage, resulting in higher premiums. According to Branley-Bell et al. (2022), there are difficulties in accurately quantifying the risk and estimating the premium due to a lack of data on risks. Wrede et al. (2022) point out that there are difficulties in quantifying cyber risks due to the lack of historical and actuarial data on the frequency and proportion of incidents. Pandey and Snekkenes (2016) assert that the transaction cost of the operation is high because the level of capitalization required to cover insurance liabilities can become unbalanced due to the intrinsic and interdependent nature of information security risks. It is found that 55.4% of respondents agree and 20.1% completely agree that factors involving the underwriting process challenge the adoption of cyber insurance, totaling 75.5% agreement. According to Tonn et al. (2022), the cyber insurance market is new and immature. Baer (2003) states that companies primarily fear acts of war; however, these risks are generally excluded from policies. According to Branley-Bell et al. (2022), the clarity in the exposure of aspects included or excluded in insurance contracts is often insufficient, making drafting a policy a complex task. Hamid et al. (2022) assert that there is still a lack of comprehensive understanding of how to protect organizations against emerging risks arising from the interdependencies between internal and external technological systems. Additionally, Branley-Bell et al. (2022) highlight that the lack of transparency in security practices and past incidents due to the scarcity of risk data represents a significant obstacle to implementing cyber insurance. It is observed that 55.4% agree and 22.3% strongly agree that the lack of standardization, metrics, and governance, along with the high complexity of decision-making, are management factors that represent obstacles to the implementation of cyber insurance, resulting in a total of 77.7% agreement. This result is in line with the findings in the literature. Tonn et al. (2022) state that the cyber insurance market needs more standardization of the terms and conditions of the coverage offered. Branley-Bell et al. (2022) highlight that the complexity of decision-making by company management makes obtaining or renewing cyber insurance an arduous process. It is found that approximately 56.1% of respondents agree, 16.5% strongly agree, and 23.7% neither agree nor disagree that factors involving risk management represent barriers to the adoption of cyber insurance, totaling 72.6% agreement. This questionnaire result aligns with the findings in the literature. According to Pandey and Snekkenes (2016), there is counterparty credit risk because a company may be exposed to the risk of the insurer going bankrupt during the contract period. Additionally, Vakili and Sengupta (2019) point out that information asymmetry can intensify moral hazard, where the client reduces their cybersecurity investment efforts after signing the policy, thereby increasing the agreed risk in the contract. Adverse selection is also a problem highlighted by the authors, as clients with higher risks are more likely to purchase insurance. At the same time, the insurer cannot distinguish these clients before the policy is signed due to information asymmetry. Hamid et al. (2022) state that companies use both proprietary and external (third-party) interconnected and interdependent systems. Given the complexity of the technology, organizations often need to understand the risks that each interdependent component presents and, therefore, need to learn how to ensure these interdependencies adequately. It is observed that, regarding factors involving indemnification, there is a greater balance in the responses. Only 37.7% of respondents agree, 12.2% strongly agree, 28.1% neither agree nor disagree, and 19.4% disagree that these are challenges in implementing cyber insurance, totaling 49.9% agreement. However, the literature points to significant challenges in this aspect. According to Branley-Bell et al. (2022), the insurance application process is challenging, as companies face difficulties in answering the questions required by insurers to acquire a policy. Additionally, Marotta et al. (2017) highlight that the indemnity limit for large corporations is lower than what could be stipulated. It is observed that 54.7% of respondents agree and 18% strongly agree that the underreporting of cyber incidents is seen as a problem to be overcome, totaling 72.7%. This result aligns with the

literature, as according to Sangari, Dallal, and Whitman (2022), many organizations prefer not to disclose that they have suffered cyberattacks, especially those involving the breach of private data, due to the risk of reputational damage. It is understood that 61.9% of respondents agree and 18.7% strongly agree, while only 5% disagree that there are stigmas related to cyber insurance, totaling 80.6% agreement. Jason Nurse et al. (2020) corroborate this factor, highlighting negative perceptions about cyber insurance that can hinder the adoption of such policies. It is analyzed that 47.5% of respondents agree, 15.8% strongly agree, and 25.9% neither agree nor disagree that various factors such as the lack of reinsurance availability to facilitate the provision of cyber insurance, the absence of experience in claims settlement, and the maximization of company profit, total 63.3% agreement. According to Kuru and Bayraktar (2017), cyber insurance protects its clients against uncertain losses and aims to maximize profits by adopting risk management strategies to defend against malicious digital threats. Wrede et al. (2022) evaluate reinsurance for cyber insurance as insufficient and highlight the inexperience in claims settlement. After choosing an option on the scale for each presented statement, respondents were asked if they had any additional comments on the challenges of adopting cyber insurance or if they wished to add any observations not previously mentioned. The comments were analyzed, and the most relevant ones are described below. Respondent 3 highlights the importance of cyber insurance in adding value to company operations by demonstrating a concern for protecting personal information, which promotes the acquisition of new clients. Respondent 12 emphasizes that cyber insurance should be compared to life insurance, as it does not eliminate adverse effects or prevent occurrences but provides resources and support after an incident, mitigating risk and controlling the situation. Respondent 31 states that, following the COVID-19 pandemic, the insurance market faced obstacles due to the increase in cyberattacks and the lack of security in companies. However, organizations are becoming increasingly aware of the importance of cybersecurity. As a result, the trend is for insurance offerings to present more competitive costs. Additionally, it is highlighted that cyber risks are currently among the top 10 challenges in the industry.

## **5. FINAL CONSIDERATIONS**

This study aimed to evaluate the importance of cyber insurance, highlighting the benefits and challenges associated with its adoption. The results indicate that cyber insurance plays a crucial role as a tool for protection against virtual threats. Its ability to mitigate the reputational impacts on companies is remarkable, contributing to minimizing damage to the organization's image. Furthermore, cyber insurance becomes attractive to potential clients by emphasizing the company's commitment to protecting information. The field research also evidenced that, as this is still an emerging market, cyber insurance has yet to mature fully. In this context, significant challenges arise related to underwriting and claims processes, risk management, and various factors ranging from risk assessment and estimation to underreporting cyber incidents. Aspects such as high premium values and transaction costs, the complexity of policy drafting, lack of clarity in identifying coverage inclusions and exclusions, and negative perceptions regarding insurance also stood out as relevant challenges. However, despite the challenges, it is imperative to recognize that these obstacles do not diminish the importance of cyber insurance. On the contrary, these difficulties underscore the urgent need for strategic actions to overcome them and expand the reach of this protection mechanism. Thus, this study contributes new concepts and knowledge, providing a comprehensive understanding of cyber insurance. In the academic sphere, the empirical research confirms the challenges and benefits of adopting cyber insurance in Brazil. In the socio-financial context, the research highlights the role of cyber insurance in company sustainability, suggesting guidelines on the main challenges to be overcome and actions aimed at simplifying the necessary points to minimize the complexity of decision-making for managers.

Regarding the limitations of this study, the research obtained 139 respondents, including experienced professionals in the field of cyber insurance and individuals with little knowledge of the subject. However, the presence of participants with varying levels of knowledge may introduce bias in the results, as perceptions can be influenced by prior understanding of the topic. As the topic is highly impacted by constant technological transformation, future research should consider updating the systematic literature review to include other databases and information sources beyond published journal articles. Additionally, conducting an in-depth case study on specific companies in the insurance sector would be important to understand the extent of cyber insurance implementation in emerging countries.

## LITERATURE:

1. Baer, W. (2003). Rewarding IT security in the marketplace. *Contemporary Security Policy*, 24(1), 190–208.
2. Bardin, L. (2011). *Análise de Conteúdo*. São Paulo, Brasil: Ed. Revista e Ampliada.
3. Baker, T. and Shortland, A. (2023). Insurance and enterprise: cyber insurance for ransomware. *The Geneva Papers on Risk and Insurance-Issues and Practice*, 48 (2), 275–299.
4. Barreto, C., Reinert, O. Wiesinger, T. and Franke, U. (2023). Duopoly insurers' incentives for data quality under a mandatory cyber data sharing regime. *Computers and Security*, 131, 103292.
5. Biener, C., Eling, M. and Wirfs, J. H. (2015). Insurability of cyber risk: An empirical analysis. *The Geneva Papers on Risk and Insurance-Issues and Practice*, 40, 131-158.
6. Biswas, B., Mukhopadhyay, A., Kumur, A. and Delen, D. (2024). A hybrid framework using explainable AI (XAI) in cyber-risk management for defence and recovery against phishing attacks. *Decision Support Systems*, 177, 114101.
7. Branley-Bell, D. Gómez, Y., Coventry, L., Vila, J. and Briggs, P. (2021). Developing and validating a behavioural model of cyberinsurance adoption. *Sustainability* 13 (17), 9528.
8. Chase, J., Niyato, D., Wang, P., Chaisiri, S. and Ko, R. K. (2017). A Scalable Approach to Joint Cyber Insurance and Security-As-A-Service Provisioning in Cloud Computing. *IEEE Transactions on Dependable and Secure Computing*, 16 (4), 565–579.
9. Cremer, F., Sheehan, B., Fortmann, M., Kia, A. N., Mullins, M., Murphy, F. and Materne, S. (2022). Cyber risk and cybersecurity: a systematic review of data availability. *The Geneva papers on risk and insurance-Issues and practice*, 47(3), 698.
10. Dacorogna, M. and Kratz, M. (2023). Managing cyber risk, a science in the making. *Scandinavian Actuarial Journal*, 2023 (10), 1000–1021.
11. Franke, U. (2017). The cyber insurance market in Sweden. *Computers and Security*, 68, 130–144.
12. Hamid, N., Mohamed, N., and Jae, Y. (2022). Barriers and enablers to adoption of cyber insurance in developing countries: An exploratory study of Malaysian organizations. *Computers and Security*, 122, 102893.
13. He, R., Jin, Z., and Li, J. S. H. (2024). Modeling and management of cyber risk: a cross-disciplinary review. *Annals of Actuarial Science*, 1-40.
14. Herr, T. (2021). Cyber insurance and private governance: The enforcement power of markets. *Regulation and Governance*, 15 (1), 98–114.
15. Hoppe, F., Gatzert, N., and Gruner, P. (2021). Cyber risk management in SMEs: Insights from industry surveys. *Journal of Risk Finance*, 22 (3/4), 240–260.
16. Jason Nurse, R. C., Creese, S., De Roure, D., Goldsmith, M., and Hodges, J. (2020). The data that drives cyber insurance: A study into the underwriting and claims processes. In *2020 International Conference on Cyber Situational Awareness, Data Analytics and Assessment, (Cyber SA)*, 1-8.

17. Kshetri, N. (2018). The economics of cyber-insurance. *IT Professional*, 20 (6), 9–14.
18. Kuru, D., and Bayraktar, S. (2017). The effect of cyber-risk insurance to social welfare. *Journal of Financial Crime*, 24 (2), 329–346.
19. Liu, Z., Wei, W., and Wang, L. (2022). An extreme value theory-based catastrophe bond design for cyber risk management of power systems. *IEEE Transactions on Smart Grid*, 13 (2), 1516–1528.
20. Liu, Z., Wei, W., and Wang, L. (2021). An actuarial framework for power system reliability considering cybersecurity threats. *IEEE Transactions on Power Systems*, 36 (2), 851–864.
21. López, I. I., and Cortés, J. A. T. (2022). El uso de productos financieros en la demanda de seguros en México. *Revista Mexicana de Economía y Finanzas*, 17 (3).
22. Markopoulou, D. (2021). Cyber-insurance in EU policy-making: Regulatory options, the market's challenges and the US example. *Computer Law and Security Review*, 43, 105627.
23. Marotta, A., Martinelli, F., Nanni, S., Orlando, A., and Yautsiukhin, A. (2017). Cyber-insurance survey. *Computer Science Review*, 24, 35–61.
24. Mukhopadhyay, A., Chatterjee, S., Saha, D., Mahanti, A., and Sadhukhan, S. K. (2013). Cyber-risk decision models: To insure IT or not? *Decision Support Systems*, 56 (1), 11–26.
25. Nobanee, H., Abdallah, A., Al-Hajjar, A. I., Al-Taweel, I. M., Arekat, Z., and Blaique, A. (2023). Mapping cyber insurance: A taxonomical study using bibliometric visualization and systematic analysis. *Global Knowledge, Memory and Communication*.
26. Niyato, D., Luong, N. C., Wang, P., and Kim, D. I. (2017). Cyber insurance for plug-in electric vehicle charging in vehicle-to-grid systems. *IEEE Network*, 31 (2), 38–46.
27. Ogbanu, O., Kim, D. J., and Jones, M. C. (2021). Informing cybersecurity strategic commitment through top management perceptions: *The role of institutional pressures. Information and Management*, 58 (7), 103507.
28. Oliveira, K. S., Méxas, M. P., and Novo, C. C. (2023). Vantagens e desafios para implementação do seguro cibernético. In *XXX Simpósio de Engenharia de Produção*.
29. Pal, R., Huang, Z., Lototsky, S., Yin, X., Liu, M., Crowcroft, J., ... and Nag, B. (2021a). Will catastrophic cyber-risk aggregation thrive in the IoT age? A cautionary economics tale for (re-)insurers and likes. *ACM Transactions on Management Information Systems*, 12 (2), 1-36.
30. Pandey, P., and Snekenes, E. (2016). Using financial instruments to transfer the information security risks. *Future Internet*, 8 (2), 20.
31. Piromsopa, K., Klima, T., and Pavlik, L. (2017). Designing model for calculating the amount of cyber risk insurance. In *2017 Fourth International Conference on Mathematics and Computers in Sciences and in Industry (MCSI)*, 196-200.
32. Rangu, C. M., Abdallah, A., Insua, D. R., Alavi, A., Chatterjee, S., and Campbell, G. (2024). Cyber insurance risk analysis framework considerations. *Journal of Risk Finance*, 25 (2), 224–252.
33. Sangari, S., Dallal, E., and Whitman, M. (2022). Modeling under-reporting in cyber incidents. *Risks*, 10 (11), 200.
34. Shackelford, S. J. (2012). Should your firm invest in cyber risk insurance? *Business Horizons*, 55 (4), 349–356.
35. Sibindi, A. B. (2015). The art of alternative risk transfer methods of insurance. *Risk Governance and Control: Financial Markets and Institutions*, 5 (4), 216–226.
36. Skeoch, H. R. K. (2022). Expanding the Gordon-Loeb model to cyber-insurance. *Computers and Security*, 112, 1025533.
37. Strupczewski, G. (2018). Current state of the cyber insurance market. In *Proceeding of Economics of Social and Economic Sciences*.

38. Tatar, U., Nussbaum, B, Gokce, Y and Keskin, O. F. (2021). Digital force majeure: The Mondelez case, insurance, and the (un)certainly of attribution in cyberattacks. *Business Horizons*, 64 (6), 775–785.
39. Tonn, G., Kesan, J. P., Zhang, L., and Czajkowski, J. (2019). Cyber risk and insurance for transportation infrastructure. *Transport Policy*, 79, 103–114.
40. Uganbayar, G., Yautsiukhin, A., and Martinelli, F. (2018). Cyber insurance and security interdependence: Friends or foes? In *2018 International Conference on Cyber Situational Awareness, Data Analytics and Assessment (Cyber SA)*, 1-4.
41. Vakulinia, I., and Sengupta, S. (2019). A coalitional cyber-insurance framework for a common platform. *IEEE Transactions on Information Forensics and Security*, 14 (6), 1526–1538.
42. Wang, L., Iyengar, S. S., Belman, A. K., Śniatała, P., Phoha, V. V., and Wan, C. (2021). Game theory based cyber-insurance to cover potential loss from mobile malware exploitation. *Digital Threats: Research and Practice*, 2 (2), 1-24.
43. Watson, T., Thakur, K., and Ali, M. (2022). The impact of purchasing cyber insurance on the enhancement of operational cyber risk mitigation of U.S. banks - A case study. In *2022 IEEE 12th Annual Computing and Communication Workshop and Conference (CCWC)*, 0709-0715.
44. Wrede, D., Stegen, T., and Graf von der Schulenburg, J. M. (2020). Affirmative and silent cyber coverage in traditional insurance policies: Qualitative content analysis of selected insurance products from the German insurance market. *The Geneva Papers on Risk and Insurance-Issues and Practice*, 45 (4), 657–689.

## LITERATURE REVIEW: SUSTAINABLE HUMAN RESOURCE MANAGEMENT

**Andrea de Sousa Figueira**

*Universidade Federal Fluminense, Brasil  
andreafigueira@id.uff.br*

**Stella Regina Reis da Costa**

*GOVCOPP  
Universidade Federal Fluminense, Brasil  
stella@ufrj.br*

**Izabela Simon Rampasso**

*Departamento de Ingeniería Industrial  
Universidad Católica del Norte, Chile  
izarampasso@gmail.com*

**David Nunes Resende**

*GOVCOPP, ESTGA, Universidade de Aveiro, Portugal;  
PCTIS, Portugal  
david@ua.pt*

### **ABSTRACT**

*Human Resource Management (HRM) is a critical area for organizational development and has evolved with strategies oriented toward sustainability principles. The increase in environmental awareness, regulatory and political pressures, stakeholder expectations, changes in the labor market, and globalization challenges—such as the United Nations Global Compact which led to the development of the Sustainable Development Goals (SDGs)—are factors contributing to the growth of scientific studies and organizational adoption of Sustainable Human Resource Management (SHRM). Given that the literature on SHRM is fragmented, diverse, and presents difficulties regarding consensus, the objective of this study is to identify and clarify the inconsistencies concerning the differences and interdependencies among the various approaches to HRM oriented toward sustainability. To achieve this objective, the study employed a systematic literature review in international databases (Scopus and Web of Science). Based on the theoretical foundation, the study identified trends in SHRM, the conceptual framework, the different aspects of associated terminologies, and a comparative analysis of HRM models. As a result, a theoretical framework of recommendations was developed to guide SHRM in contributing to the achievement of the SDGs. Given the lack of consensus on SHRM, further research, particularly empirical studies, is necessary to consolidate terms, concepts, and the feasibility of SHRM practices. Additionally, SHRM models could be developed to support governments, businesses, institutions, and organizations, thereby meeting the sustainability demands of society, science, and organizations.*

**Keywords:** *SDG, Sustainable Human Resource Management, Sustainability, Human Resources*

### **1. INTRODUCTION**

Sustainable Human Resource Management (SHRM) has emerged as an innovative approach to people management, representing a significant evolution from Strategic Human Resource Management (Strategic HRM), which historically focused predominantly on financial and market outcomes (Kramar, 2022). SHRM is distinguished by its integration of sustainability principles into management practices, reflecting a shift from a primarily economic focus to a

model encompassing social and environmental responsibilities (Murillo-Ramos *et al.*, 2023). The complexity of the field is evidenced by the various theories and models aiming to align sustainability with human resource management, highlighting the need for a holistic and integrated approach to SHRM (Piwowar-Sulej, 2021; Chams & García-Blandón, 2019). The ongoing development of theoretical models and effective practices is crucial for the successful implementation of SHRM, ensuring that organizations not only comply with regulations but also foster positive, lasting impacts across economic, social, and environmental dimensions of sustainability (Macke & Genari, 2019; De Vos & Van der Heijden, 2017). In this context, the literature review on SHRM aims to identify consensuses in its definition and trends in academic work in the field, with the primary goal of proposing recommendations that contribute to achieving the Sustainable Development Goals (SDGs). By working towards sustainability and the achievement of the SDGs, the HR sector contributes to a more sustainable and equitable future, strengthens organizational strategy and performance, enhances reputation, and increases companies' ability to attract and retain talent.

## 2. METHODOLOGY

To identify relevant studies on Sustainable Human Resource Management (SHRM), a systematic search of the academic literature was conducted during March 2024. The search was applied to the academic databases Scopus and Web of Science, using the Boolean combination “sustainable people management” OR “sustainable human resource management” and filters to select only articles published in peer-reviewed journals in their final stage of publication. The consolidation of the searches resulted in 353 articles, of which, following the application of the PRISMA method (Moher *et al.*, 2009), as illustrated in Figure 1, 98 relevant articles were identified.

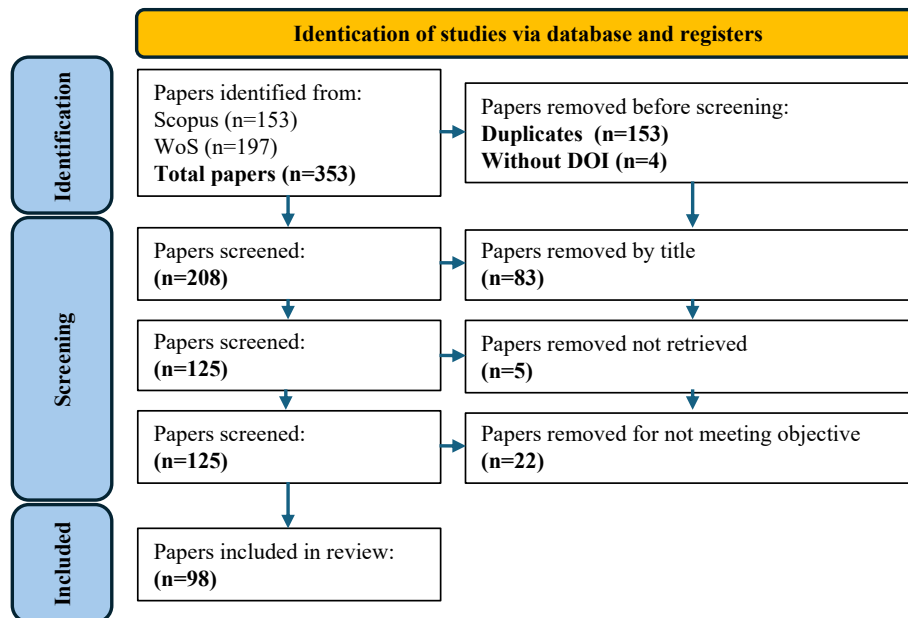

Figure 1: PRISMA Flowchart

Source: Prepared by the author based on <http://www.prisma-statement.org/> (2024)

## 3. RESULTS AND DISCUSSION

Based on the literature review, Figure 2 was developed to represent the conceptual logic of relationships and overlaps among the various concepts related to Sustainable Human Resource Management (SHRM). SHRM represents the apex of the sustainability conceptual pyramid, integrating and promoting practices that balance the economic, social, and environmental

dimensions to ensure the long-term success of organizations. Organizational sustainability serves as the foundation of this structure, focusing on organizations' ability to thrive and adapt to changes while incorporating the principles of the United Nations Sustainable Development Goals (SDGs), which guide global actions to meet current needs without compromising future generations (Chams & García-Blandón, 2019; Kramar, 2022). Within this context, the Triple Bottom Line (TBL) and Corporate Social Responsibility (CSR) are crucial tools guiding the practice of organizational sustainability. Meanwhile, SHRM, by integrating innovations and promoting sustainable practices, seeks continuous transformation and improvement of human resource management practices to align organizational operations with global sustainability goals (Mukherji & Bhatnagar, 2022; Tseng *et al.*, 2020).

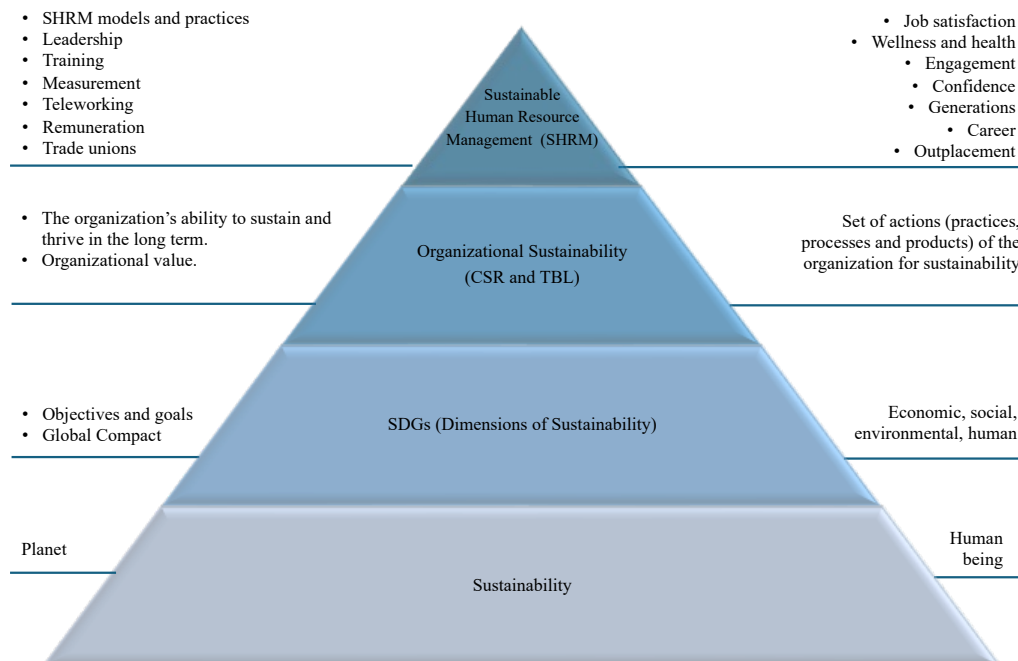

Figure 2: Conceptual logic of Sustainable Human Resource Management (SHRM)  
Source: Created by the author (2024)

The analysis of the articles revealed the main discussion areas and emerging themes related to Sustainable Human Resource Management (SHRM) (Table 1). Among the most frequently discussed themes are “SHRM models,” which explore different approaches and structures for integrating sustainability into people management, as discussed by Kramar (2014) and Macini *et al.* (2023). “Employee engagement” is a central focus, evidenced by the analysis of Murillo-Ramos *et al.* (2023) and Piwovar-Sulej (2021), which explores how sustainable practices can influence employee motivation and involvement. “Employee well-being” is discussed by Madero-Gómez *et al.* (2023) and Tutar *et al.* (2023), highlighting how SHRM practices contribute to improving workplace quality of life and increasing productivity. “SHRM practices” are evaluated for their effectiveness and practical application, as shown by Faisal (2023) and Chams & García-Blandón (2019). “Leadership” is identified as a critical factor for implementing and promoting organizational sustainability, with an emphasis on the need for leaders to integrate sustainable values into their strategies and actions, as analyzed by Kainzbauer *et al.* (2021) and Macke & Genari (2019). Discussions on “leadership” highlight the importance of leaders who not only support sustainability but also inspire and motivate their teams to achieve sustainable goals. Kainzbauer & Rungruang (2019) and De Vos & Van der Heijden (2017) corroborate that, despite the various approaches and models of SHRM, there is a growing consensus on the importance of sustainable practices, employee well-being, and



effective leadership in promoting organizational sustainability. Additionally, other themes also appear in lesser quantities, as illustrated in Table 1. The first column presents the themes, the second column shows the number of occurrences of each theme, and the third column provides an overview of how the themes are addressed in the articles.

Themes related to SHRM	Nº	Overview
SHRM Model	16	Present conceptual models' proposal for SHRM. Some propose general models, while others suggest models for specific sectors, such as the banking industry
Well-being/mental health	9	Address practices focused on employee well-being. Also examines health impact due to work, including mental health issues, stress, and physical exhaustion.
Engagement	9	Categorized as employee engagement, these articles address issues such as employee commitment and motivation towards work. The various articles relate engagement to teamwork, turnover, internal communication, organizational performance, and resilience
SHRM Practices	7	Present SHRM practices such as green recruitment and selection, green compensation, and environmental performance improvement. Also includes practices specific to certain sectors.
Leadership	4	Discusses the importance of leadership in SHRM
Organizational performance	3	Analyze SHRM in relation to organizational performance
Generations	2	Studies the relationship between SHRM and different generations, with a focus on the younger generation
Industry 4.0	2	Analyze the impacts of industry 4.0 on SHRM
Factors/Variables in the SHRM	2	Identify the factors and variables that impact SHRM
Organizational value	2	Examine SHRM as an organizational value
Teleworking	2	Discuss how teleworking as a strategy within SHRM
Career	2	Examine the impact of SHRM on employee careers, organizational attractiveness, and growth
Trust	2	Examines the impacts of trust on SHRM. Trust is a fundamental component of human relationships that affects various aspects of individuals' lives.
Supply Chain	2	These studies focus on sustainable practices ranging from talent development to supplier management and regulatory compliance.
SHRM Adoption	2	Address the process of adoption/implementation of SHRM in organizations
Job satisfaction	2	Examine SHRM as a mediator of job satisfaction
Training	1	Investigates training as a significant variable for the SHRM
Adaptive Performance	1	Study on the adaptive performance of professionals in relation to SHRM
SHRM Analysis	1	An earlier study of SHRM within this research
Remuneration	1	Study on compensations practices during periods of crisis
Trade unions	1	Trade unions in SHRM
Outplacement	1	Outplacement programs as a SHRM action
Measurement Instruments	1	Proposal of a measurement instrument to assess SHRM
Customer Satisfaction	1	Study of the influence of SHRM on customer satisfaction and service quality.
Future of work	1	Research on the future of work relating SHRM as part of the trend
Organizational results	1	Examines SHRM as a driver of positive organizational outcomes
Employee Perception	1	Study on employee perceptions of SHRM
ISO	1	Aligns SHRM activities with ISO standards
TOTAL	80	

Table 1: List of themes related to SHRM in the articles

Source: Created by the author (2024)

Different terminologies were identified, corroborating Kramar (2014), who highlighted the lack of consensus regarding definitions of Sustainable Human Resource Management (SHRM). Most of the listed articles also point to this lack of agreement, fragmentation, diversity, and difficulties concerning consensus on the concept of SHRM (Murillo-Ramos *et al.*, 2023; Macini *et al.*, 2023; Madero-Gómez *et al.*, 2023; Ahn & Avila, 2022; Mukherji & Bhatnagar, 2022; Kainzbauer *et al.*, 2021; Anlesinya & Susomrith, 2020). Some recent studies, such as Murillo-Ramos *et al.* (2023), seek to clarify the ambiguity regarding the differences and interdependencies among the various approaches to Human Resource Management oriented towards sustainability, specifically SHRM. Conversely, Tutar *et al.* (2023) refutes this idea, asserting that although there are linguistic innovations regarding SHRM, sustainability is a substantive and materialized approach, rather than merely theoretical or abstract. Table 2 presents the identified terminologies and references.

Terminologies related to SRHM identified in the literature review	
Terminology	References
<b>Sustainable HRM</b>	Macini <i>et al.</i> , 2023; Tutar <i>et al.</i> , 2023; Madero-Gómez <i>et al.</i> , 2023; Faisal, 2023; Ahn & Avila, 2022; Piwowar-Sulej, 2021; Ribeiro & Gavronski, 2021; Kumar <i>et al.</i> , 2020; Anlesinya & Susomrith, 2020; Chams & García-Blandón, 2019; Macke & Genari, 2019; De Vos & Van der Heijden, 2017
<b>Green HRM</b>	Murillo-Ramos <i>et al.</i> , 2023; Mukherji & Bhatnagar, 2022; Kainzbauer <i>et al.</i> , 2021; Amrutha & Geetha, 2020; Santana & Lopez-Cabrales, 2019
<b>Socially Responsible HRM</b>	Murillo-Ramos <i>et al.</i> , 2023; Faisal, 2023; Mukherji & Bhatnagar, 2022; Ahn & Avila, 2022; Piwowar-Sulej, 2021
<b>Common Good HRM</b>	Ahn & Avila, 2022; Faisal, 2023; Kainzbauer <i>et al.</i> , 2021
<b>Triple Bottom Line HRM</b>	Ahn & Avila, 2022; Faisal, 2023; Kumar <i>et al.</i> , 2020

Table 2: Terminologies related to SHRM identified in the literature review  
(Source: Prepared by the author, 2024)

Another outcome of this study was the development of a comparative framework on HRM models, as illustrated in Table 3. According to Macini *et al.* (2023), HRM evolves as the competitive environment changes, with SHRM emerging as an evolving approach, representing an extension of Strategic Human Resource Management (Strategic HRM). Financial focus has been the primary concern of HRM over the years (Stankevičiute & Savanevičiene, 2018; Chams & García-Blandón, 2019). Similar to SHRM, which focuses on aligning HR practices primarily with the company's financial objectives, SHRM takes into account the demands of various stakeholders, including employees, customers, shareholders, and the broader community (Poon & Law, 2022; Kramar, 2022). According to Kainzbauer & Rungruang (2019), SHRM is a new and complex field of study due to the variety of definitions and approaches, involving the intellectual framework of four schools of thought influencing SHRM: Green HRM (GHRM), sustainable supply chain management, SHRM/CSR/Strategy, and corporate sustainability. SHRM is positioned at the intersection of these four research streams. The concept of GHRM is frequently presented in studies as a dimension of SHRM, with the "green" aspect representing the environmental dimension (Murillo-Ramos *et al.*, 2023).

According to Kainzbauer *et al.* (2021), GHRM is one of the three “invisible faculties” of SHRM, alongside Socially Responsible HRM (SR-HRM) and the Triple Bottom Line HRM (TBL-HRM).

Comparative framework on HRM models					
Aspects	Human Resource Management (HRM)	Strategic Human Resource Management (Strategic HRM)	Green Human Resource Management (GHRM)	Socially Responsible HRM (SR-HRM)	Sustainable Human Resource Management (SHRM)
<b>Main Focus</b>	Operational and administrative	Alignment with organizational strategy	Environmental sustainability	Social responsibility and ethics	Balance between economic, social, and environmental aspects
<b>Objectives</b>	Manage daily HR functions such as recruitment, training, and personnel administration	Maximize organizational performance through HR alignment with business strategy	Reduce environmental impact	Employee rights and positive community impact	Long-term sustainability, employee well-being, and positive environmental impact
<b>Practical Examples</b>	Recruitment, training, benefits administration, legal compliance	Succession planning, leadership development, aligning HR with strategic goals	Energy reduction, recycling, sustainable transportation	Diversity policies, fair compensation, volunteer programs	Sustainable development, work-life balance, eco-friendly work practices
<b>Focus on Performance</b>	Primarily on the efficiency and effectiveness of daily HR operations	Focus on HR's contribution to strategic performance	Emphasizes practices that reduce environmental impact and promote ecological efficiency	Prioritizes practices that promote social justice and community benefits	Integrates HR practices with sustainability goals, aiming for balance across various dimensions

*Table 3: Comparative framework on HRM models  
(Source: Prepared by the author, 2024)*

Finally, a model of recommendations was developed to ensure that SHRM contributes to the achievement of the Sustainable Development Goals (SDGs), as illustrated in Table 4. Defined by the United Nations' 2030 Agenda, the SDGs comprise a set of 17 targets aimed at addressing global challenges such as poverty, inequality, climate change, and environmental degradation (SDGs, 2024). The SDGs have a profound impact on SHRM strategies (Afeltra *et al.*, 2022), providing a strategic framework that guides HR policies and practices to align organizational objectives with global sustainability goals (Kramar, 2022). Adopting the SDGs in organizational SHRM practices results in aligning sustainable goals with employee expectations; attracting and retaining talent that values responsible and sustainable practices; promoting waste reduction and efficient energy consumption; increasing employee awareness; improving productivity; and enhancing job satisfaction (Campos-Garcia *et al.*, 2024). The Organization for Economic Co-operation and Development (OECD) underscores the importance of the SDGs in HRM by providing analyses and recommendations to help countries implement sustainable and responsible practices (OECD, 2024). Consequently, SHRM plays a vital role in promoting various SDGs within organizations (Madero-Gómez *et al.*, 2023). In summary, integrating the SDGs into HRM practices not only enhances organizational sustainability performance but also strengthens the organization's reputation and attractiveness as an employer. Organizations that align their HRM practices with the SDGs advance toward sustainable development and contribute to a more equitable and sustainable future for all (Afeltra *et al.*, 2022; Campos-Garcia *et al.*, 2024; Madero-Gómez *et al.*, 2023).

*Table following on the next page*

<b>Recommendations for the GSRH to contribute to achieving the SGDs</b>		
<b>SGD</b>	<b>Discussion/Recommendations</b>	<b>Reference</b>
<b>Poverty Eradication (SDG 1)</b>	Explore how HRM practices can contribute to less unequal environments. Provide inclusive employment opportunities for reduce poverty both within the environment and in the organization itself.	Campos-Garcia et al. (2024)
<b>Good Health and Well-Being (SDG 3)</b>	Evaluate the impact of workplace health programs, work-life balance policies, access to adequate health care, promotion of healthy lifestyles, and attention to physical and mental health. This is linked to employee benefits.	Madero-Gómez et al. (2023), Campos-Garcia et al. (2024), Kramar (2022)
<b>Quality Education (SDG 4)</b>	Explore the impact of corporate educational programs.	Madero-Gómez et al. (2023)
<b>Gender Equality (SDG 5)</b>	Explore leadership programs for women, eliminate gender bias in promotion, and develop beyond gender-inclusive talent and resilience management.	Madero-Gómez et al. (2023), Campos-Garcia et al. (2024), Kramar (2022)
<b>Decent Work and Economic Growth (SDG 8)</b>	Study fair pay policies, decent jobs, skills development, and inclusive opportunities. This is related to job satisfaction, employee motivation, and leadership style.	Madero-Gómez et al. (2023), Campos-Garcia et al. (2024), Kramar (2022)
<b>Industry, Innovation, and Infrastructure (SDG 9)</b>	Investigate the integration of sustainable practices in corporate infrastructure.	Campos-Garcia et al. (2024)
<b>Reduced Inequalities (SDG 10)</b>	Study inclusion and diversity policies in workplace contexts.	Madero-Gómez et al. (2023), Kramar (2022)
<b>Sustainable Cities and Communities (SDG 11)</b>	Assess the effectiveness of sustainable work practices in urban contexts. Promote sustainable work practices, such as waste reduction, energy efficiency, sustainable transport and community engagement.	Campos-Garcia et al. (2024)
<b>Responsible Consumption and Production (SDG 12)</b>	Study the effectiveness of responsible consumption initiatives. HR can support this SDG through employee behavior.	Campos-Garcia et al. (2024)
<b>Climate Action (SDG 13)</b>	Investigate the impact of sustainable practices on reducing emissions. HR can support this SDG by influencing employee behavior, which can also enhance GHRM.	Campos-Garcia et al. (2024)
<b>Partnerships for the Goals (SDG 17)</b>	HR professionals should foster public-private partnerships to address sustainable challenges. Invest in innovation and technology to develop sustainable solutions.	Kramar, 2022; Afeltra et al. (2022)

*Table 4: Recommendations for SHRM to achieve the SDGs  
(Source: Prepared by the author, 2024)*

#### 4. CONCLUSION

This study reveals a significant evolution in people management, moving beyond the traditional focus on financial results to incorporate social and environmental sustainability aspects. Sustainable Human Resource Management (SHRM) emerges as an innovative approach that integrates sustainable principles into management practices, reflecting the need for a more holistic and integrated view of human resource management. The analysis of existing practices and models highlights the complexity and fragmentation of the field, evidenced by the lack of consensus and the diversity of definitions and approaches regarding SHRM. Despite the challenges in establishing a universal agreement on the concept and its practices, there is a growing recognition of the importance of incorporating sustainable practices into human resource management. The studies identify emerging trends, a conceptual comparison for guidance and understanding of SHRM, as well as the integration of the Sustainable Development Goals (SDGs) into SHRM practices, which provide a strategic framework for aligning organizational practices with global sustainability goals. Adopting the SDGs can not only enhance the sustainable performance of organizations but also strengthen their reputation and attractiveness as employers. The review also highlights the need for further empirical research to consolidate SHRM concepts and practices. Models and theoretical frameworks should continue to be developed to guide organizations in the effective implementation of

sustainable practices. Organizations that adopt SHRM can contribute to a more sustainable future by addressing not only regulatory and market demands but also promoting positive impacts across economic, social, and environmental dimensions.

**ACKNOWLEDGEMENT:** *This work was financially supported by the research unit on Governance, Competitiveness and Public Policy (UIDB/04058/2020) and (UIDP/04058/2020), funded by national funds through FCT - Fundação para a Ciência e a Tecnologia., and by the Coordenação de Aperfeiçoamento de Pessoal de Nível Superior – Brasil (CAPES) – Finance Code 001.*

## LITERATURE:

1. Afeltra, G.; Alerasoul, S. A.; Minelli, E.; Vecchio, Y.; Montalvo, C. (2022). Assessing the Integrated Impact of Sustainable Innovation on Organisational Performance: An Empirical Evidence From Manufacturing Firms. *Journal of Small Business Strategy*, 32(4), 143–166.
2. Ahn, J.-Y. & Avila, E.J. (2022). An exploration of research clusters of sustainable human resource management. *Problems and Perspectives in Management*, v. 20 (2), p. 84-95
3. Amrutha, V.N. & Geetha, S.N. (2020). A systematic review on green human resource management: Implications for social sustainability. *Journal of Cleaner Production*, v. 247, n. 11913
4. Anlesinya, A. & Susomrith, P. (2020). Sustainable human resource management: a systematic review of a developing field. *Journal of Global Responsibility*, v. 11 (3), p. 295-324
5. Campos-García, I.; Alonso-Munõz, S.; González-Sánchez, R.; Medina-Salgado, M. (2024). Human resource management and sustainability: bridging the 2023 agenda. *Corporate Social Responsibility and Environmental Management*, pp. 2033-2053
6. Chams, N. & García-Blandón, J. (2019). On the importance of sustainable human resource management for the adoption of sustainable development goals. *Resources, Conservation and Recycling*, v. 141, p. 109-122
7. De Vos, A.; Van Der Heijden, B. I. (2017). Current thinking on contemporary careers: the key roles of sustainable HRM and sustainability of careers. *Current Opinion in Environmental Sustainability*, v. 28, p. 41-50
8. Faisal, S. (2023). Twenty-Years Journey of Sustainable Human Resource Management Research: A Bibliometric Analysis. *Administrative Science*, v. 13 (6), n. 139
9. Kainzbauer, A. & Rungruang, P. (2019). Science mapping the knowledge base on sustainable human resource management, 1982-2019. *Sustainability*, v. 11(14), n. 3938
10. Kainzbauer, A.; Rungruang, P.; Hallinger, P. (2021). How does research on sustainable human resource management contribute to corporate sustainability: A document co-citation analysis, 1982–2021. *Sustainability*, v. 13(21), n. 11745
11. Kramar, R. (2022). Sustainable human resource management: six defining characteristics. *Asia Pacific Journal of Human Resources*, v. 60 (1), p. 146-179
12. Kumar, A.; Bhaskar, P.; Nadeem, S.P.; Tyagi, M.; Garza-Reyes, J.A. (2020) Sustainability adoption through sustainable human resource management: A systematic literature review and conceptual framework. *International Journal of Mathematical, Engineering and Management Sciences*, v. 5(6), p. 1014-1031.
13. Macini, N.; Sengupta, A.; Moin, M. F.; Caldanha, A. C. F. (2023). A systematic literature review of the relationship between sustainable human resources management and spiritual leadership. *Human Systems Management*, v. 42 (3), p. 257-276
14. Macke, J. & Genari, D. (2019) Systematic literature review on sustainable human resource management. *Journal of Cleaner Production*, v. 208, p. 806-815

15. Madero-Gómez, S. M.; Leal, Y. L. R.; Olivas-Luján, M; Yusliza, M. Y. (2023). Companies Could Benefit When They Focus on Employee Wellbeing and the Environment: A Systematic Review of Sustainable Human Resource Management. *Sustainability*, v. 15 (6), n. 5435
16. Moher, D., Liberati, A., Tetzlaff, J., Altman, D. G., The PRISMA Group. (2009). Preferred reporting items for systematic reviews and meta-analyses: The PRISMA statement. *PLoS Med*, 6(7), e1000097
17. Mukherji, A. & Bhatnagar, J. (2022). Conceptualizing and theorizing green human resource management: a narrative review, *International Journal of Manpower*, v. 43 (3), p. 862-888
18. Murillo-Ramos, L.; Huertas-Valdivia, I.; García-Muiña, F. E. (2023). Exploring the cornerstones of green, sustainable and socially responsible human resource management. *Internacional Journal of Manpower*, v.44(3), pp. 524-542
19. OCDE – Organisation for Economic Co-operation and Development. Tackling coronavirus (Covid-19). Productivity gains from teleworking in the post COVID-19 era: how can public policies make it happen? Paris, França: OCED, 2020. Retrieved 23/06/2023 from <http://www.oecd.org/coronavirus/policy-responses/productivity-gains-fromteleworking-in-the-post-covid-19-era-a5d52e99/>.
20. Poon, T. S.-C. & Law, K. K. (2022). Sustainable HRM: An extension of the paradox perspective. *Human Resource Management Review*, v. 32 (2), n. 100818, 2022
21. Piwowar-Sulej, K. (2021). Core functions of Sustainable Human Resource Management. A hybrid literature review with the use of H-Classics methodology. *Sustainable Development*, v. 29 (4), p. 671-693, 2021
22. Ribeiro, R. P. & Gavronski, I. (2021). Sustainable management of human resources and stakeholder theory: a review. *Revista de Gestão Social e Ambiental*, v. 15, n. e2729
23. Santana M. & Lopez-Cabrales A. (2019). Sustainable development and human resource management: A science mapping approach. *Corporate Social Responsibility and Environmental Management*, v. 26 (6), p. 1171-1183
24. Stankevičiute, Živile & Savanevičiene, Asta. (2018). Designing sustainable HRM: The core characteristics of emerging field. *Sustainability*, v.10 (12), n. 4798
25. Tseng M.; Chang, C.; Lin, C. R.; Wu, K.; Chen, Q.; Xia, L.; Xue, B. (2020). Future trends and guidance for the triple bottom line and sustainability: a data driven bibliometric analysis. *Environmental Science and Pollution Research*, v.27, pp. 33543-33567
26. Tutar H.; Nam S.; Güler S. (2023). Development of Sustainable Human Resources in the Period 2000-2021: A Bibliometric Review. *Journal of Chinese Human Resource Management*, v. 14 (1), p. 117-139

## **CRISIS COMMUNICATION IN ADVERTISING AGENCIES: STRATEGIES AND PRINCIPLES OF ITS EFFECTIVE MANAGEMENT ON SOCIAL MEDIA**

**Veronika Stevcat Szaboova**

*Constantine the Philosopher University in Nitra*

*Dražovská 4, Nitra 949 01, Slovakia*

*veronika.szaboova.ukf@gmail.com*

### **ABSTRACT**

*The main aim of the author's professional scientific interest is: "to create a theory of crisis communication in advertising agencies as a segment of the creative industry", due to the fact that this area has not been explored, in the Czech-Slovak context it is not given scientific attention. The current paper, with its content and findings, follows the author's previous articles (ŠTEVČAT SZABÓOVÁ, V.: Crisis Communication in the Creative Industry: Specifics of B2B and B2C Communication of Advertising Agencies. Trnava: UCM, 2023, p. 385-395; SZABÓOVÁ, V., SPÁLOVÁ, L.: Crisis Communication in the Creative Industry. Cambridge: Aricon, 2019. p. 24-37; SZABÓOVÁ, V. Crisis Communication in Creative Industries and its staffing. Trnava: UCM, 2019, p. 335-352) and discusses crisis communication of creative workers on social media. Firstly, because it discusses the escalating need and necessity of using social media for crisis communication (PŘIKRYLOVÁ J. ET AL., 2019), but also because the author's previous research has revealed a shift to the online space as the most prominent feature of crisis communication in advertising agencies - the crises that advertising agencies manage often arise there, but at the same time, social media platforms are a tool for a reactive approach to resolve them or a way of a proactive approach to prevent them. On the basis of the above-mentioned starting point, the principles of effective crisis communication, which can be applied in times of crisis, were formulated in direct participation with the employees of leading Slovak advertising agencies, who formed the research file of this study. The study also defines other characteristics of crisis communication in the creative industry - it is devoted to the identification of the applied approach, i.e. whether an active effort to resolve, a blind defense of the brand or a passive approach in the form of ignoring the emerging problem dominates. It also captures the state of play regarding the use of crisis communication prevention tools by people in the creative industries, also in direct application to the social media environment.*

**Keywords:** *Advertising agencies, Crisis Communication, Creative industry, Crisis communication strategies, Media, Social media*

### **1. INTRODUCTION**

In the context of the research carried out so far and based on its results, we have focused our scientific interest on social media, or rather social networks, and their role in public relations, or more specifically in crisis communication of advertising agencies. Given the results of the content analysis of the data that highlighted the nature of crisis communication in the creative industry, we identified the transition to the online environment as the most significant characteristic of crisis communication in this segment; it is here that crises in the creative sector occur most frequently and it is also the place where those in charge of digital platforms – especially social networks – proactively approach them in order to stabilize the situation and resolve it (Szabóová - Spálová, 2019). The present study discusses part of the results of the author's dissertation (Szabóová, 2021) and formulates a set of recommendations for practice that emerged from the research and were defined in direct participation with advertising agency staff.

## 2. THEORETICAL DEFINITION OF SOCIAL MEDIA AND SOCIAL NETWORKS AND THEIR POSITION IN PR

In crisis communication, those responsible for it (communication managers, PR managers, spokespersons, etc.) use various tools to establish communication with stakeholders, whether before, during, or after the crisis. These are mainly *media relations* (relations with journalists, statements to the media...), *personal communication with stakeholders*; *own media* (internal media and channels) and ***social networks and social media*** (monitoring discussions, answering questions and informing online) (Hejlová, 2015). Before moving on to the specifics of social-mediated crisis communication, the SMCC (*Social-Mediated Crisis Communication*) Model, we find it necessary to define the terms social media and social networks, as they are often misapplied. “Social media may be called a ‘strategy and market for broadcasting’, while social networks are a tool and an aid for connecting with other people” (Cohen in Vlad, 2020, p. 78). Apart from semantics, there are also differences in functionality and features, e.g. social media is a media tool that is mainly used to transmit or share information to a wide audience, while social networking is considered as a bonding of people with common interests whose aim is to connect and build relationships in a community; another difference is the style of communication and equally its speed and dynamism (Bedell in Vlad, 2020). Social media is thus superior to social networks; the term social media is an umbrella term for a wide range of web-based tools and applications that enable a community to meet, communicate, and generate opinions and ideas. Social media activates social networks, generating and enabling access to content. In turn, social networks use one or more social media tools to provide connectivity, interaction, communication, and information exchange among people (Simon in Vlad, 2020). The use of social media sites for social networking has become an effective form of communication in a formal/professional context (LinkedIn) or in a personal context (Facebook, Instagram, etc.) (Vega-Castaneda - Castaneda, 2019). However, there is currently talk in the marketing industry of a slight fusion of the above, i.e., that users are starting to post more posts with personal content on LinkedIn. In terms of the division of public relations into four models (see Table 1), social media is considered a typical PR tool of the two-way symmetrical model, which seeks to create a space for dialogue between the organization and stakeholders, and the objectives are tailored to the audience (Hejlová according to Grunig-Hunt in Chudinová, 2019).

*Table following on the next page*



	<b>Press Model</b>	<b>Public Information Model</b>	<b>Two-Way Asymmetric Model</b>	<b>Two-Way Symmetric Model</b>
<b>Type of Communication</b>	One-way	One-way	Rather one-way	Two-way balanced
<b>Means of Communication</b>	Propaganda	Dissemination of information	Scientific objective persuasion	Mutual understanding
<b>Intent of Communication</b>	Affect and manipulate the behavior and attitudes of the audience in accordance with the intentions of the organization	Mainly use media for dissemination of own one-way information, frequent manipulation	Use information and the latest scientific knowledge to create a targeted picture of an organization without emphasis on feedback	Create space for dialogue between an organization and stakeholders, adapt organization's objectives to the audience
<b>Typical Personality</b>	Creel Committee	Ivy Lee, Carl Byoir, P.T. Barnum	Bernays, corporations by the second half 20th century	Joint work of PR professionals and representatives of organizations
<b>A Typical Example of a PR Tool</b>	Editorial, leading article	Press release	Press conference	<b>Social networks</b>
<b>Period of Highest Impact</b>	From World War I to World War II	From the late 19th century to the end of World War II	1930s-1990s	since the 1990s

*Table 1: PR Models According to J. Grunig and T. Hunt 1984 and the Position of Social Networks (Source: Hejlová in Chudinová, 2019, p. 20)*

The primary goal of public relations is not only to build a good reputation and strengthen a positive image, but also, thanks to alternative forms such as content marketing, to form a base of loyal customers through the creation and publication of valuable and relevant content planned precisely on the basis of the needs of the audience, which are regularly mapped. Useful methods involve opinion polls as well as simple interviews with representatives of the target group, analyses of comments on social networks, statuses in groups, on forums (in the Slovak market, an example of such a popular forum is the *Modrý koník* website), etc.

### **3. SMCC MODEL - CRISIS COMMUNICATION MEDIATED BY SOCIAL MEDIA**

The rise of social media has changed the landscape of crisis communications in at least two important ways. Firstly, social media can be a source of organizational crisis, e.g., because of a misguided or poorly designed campaign or because of a message/post on a social network that damages the reputation of the organization/company/entity. Secondly, social media platforms have become major means for the malicious transmission of rumors, sharing of negative opinions, and aggregation of negative emotions about the organization/brand/person (Austin - Jin, 2016). Therefore, in the context of the social media boom, there is a growing discussion about the necessity of applying the so-called SMCC (Social-Mediated Crisis Communication) Model (Přikrylová et al., 2019) that discusses the involvement of social media in crisis communication. Based on the results of Phase II of our comprehensive research, we would like to note that only 9.4% of the respondents (advertising agency staff) were familiar with the

SMCC Model (Szabóová, 2021). The SMCC framework was primarily developed as a tool to help those affected (people responsible for communication in various positions) to have a facilitated decision-making process on when and how, or if at all, to respond using social media, thus emphasizing the importance of integrating social media into the overall media mix for crisis communication (Liu - Jin - Austin - Janoske in Austin - Jin, 2016). This means that even if the social media platform is not the primary focal point of the crisis, crisis communication should be complementary to it – we may speak of an *integrated crisis communication*. Communication on social media can have a human (more personal) tone-of-voice or a corporate (impersonal) tone-of-voice, which might have a different impact on the success of the communication (Searles - Weinberger; Kelleher; Jahng - Hong in Špoljarić, 2021). As stated by Austin – Jin (2016) in their study, the SMCC Model includes five criteria for organizations/firms/individuals to consider when responding to emerging issues and crises, namely: 1) *the occurrence of the crisis*, 2) *the type of crisis*, 3) *the organizational infrastructure*, 4) *the crisis response strategy*, and 5) *the form of communication sharing*. Crisis response strategies mediated by social media may range continuously from defensive to accommodative strategies. Defensive strategies separate blame for the crisis from the organization/person and often include a combination of plaintiff attack, denial, or scapegoating strategies. In contrast, accommodative strategies emphasize image repair that is necessary when reputational risk is elevated (Jin - Liu in Austin - Jin, 2016). Jin and Liu (in Austin - Jin, 2016), the authors of the SMCC Model, incorporated the rumor/gossip cycle into the crisis response strategy selection process and designed communication strategies according to the stage of rumor transmission, i.e., whether the rumor is in the stage of creation, trust, or spread (see Table 2).

*Table following on the next page*

Response Options	Strategies	Phases of Defamation (duration of the crisis)			Recovery from the Crisis (post- crisis)
		Developme nt	Belief in rumo r	Disseminati on	
<b>basic</b>	Instructions/ briefing				
	Corrective measure				
	Emotional support				
<b>Defensive</b>	<b>Denial</b>	Attack on the plaintiff			
		Refusal			
		Scapegoat			
		Ignoring			
	<b>Diminution</b>	Apology			
		Justification			
		Separation			
	<b>Renewal</b>	Compensation			
		Apology			
		Transcendence			
	<b>Strengthening</b>	Support			
		Gratitude			
Victim					
Acknowledgement					
<b>Punishment</b>	Legal action				

 Strategy recommended for the phase

*Table 2: Crisis Response Strategies in the Context of Social Media and Rumor Spreading  
(Source: Liu - Jin - Austin - Janoske in Austin - Jin, 2016, p. 173)*

In the context of social media, the response of punishment is not recommended in crisis communication (Austin - Jin, 2016), however, if rumors, untruths, are spread that border on the crime of defamation, the person or organization concerned has the right to file a criminal report and take legal action. In Slovakia, Facebook is the most powerful social network. Many FB pages of brands, companies and well-known personalities function as a kind of “wish and

complaint book” – people want to share their opinion or question, and naturally expect feedback. But when it does not come, people feel ignored and start demanding answers, usually in a more hostile tone than at the beginning. This may be identified as the point at which a crisis situation arises (Reputational Crisis on Social Media – How to Deal with It?, 2015); it also refers to one of the three most common types of crises that occur on social media according to Coombs (in Jin - Austin, 2020), namely to a *challenge*, as it is often about the failure to meet or disruption of stakeholder expectations, rather than constructive criticism of a real failure/oversight. The three most common types of crisis situation mentioned are as follows:

- 1) **Entity mistreatment/misbehavior** – the organization/person/brand violates the standards of behavior; in response it should apologize for the mistake and outline steps for future remediation or make a promise that similar behavior shall not happen again.
- 2) **Dissatisfied customers** – a reflection of poor customer relations that eventually escalated into a crisis.
- 3) **Challenge** – a crisis situation where stakeholders perceive the organization’s behavior/policies as inappropriate and irresponsible, thus undermining their expectations. A crisis of this type manifests itself in three subtypes: 1) *organic*, blamed on a poor understanding of changes in stakeholder values and interests, 2) *exposure/discovery*, where the cause of the crisis is a mismatch between actions and promises/words, and 3) *villain*, where we are talking about a long-standing conflict or quarrel with a particular group of the public (Coombs in Jin - Austin, 2020).

After reviewing scholarly studies on crisis communication in relation to social media, we conclude that social media can be perceived in two ways. Firstly, they are an important tool in dealing with crises that have arisen outside of social media, providing a platform for the two-way transmission of information that needs to be promptly distributed to stakeholders. On the other hand, however, social media have become a focal point for crises as the public considers it as the fastest communication channel between the affected company/person and its stakeholders, and thus contacts them in times of dissatisfaction through this public form. We speak of an *e-WOM* (electronic word-of-mouth) that W. T. Coombs and S. J. Holladay (in Apuke - Tunca, 2019) identified as an aspect that causes the rapid spread of a crisis. However, it is the factor of anonymity that equally plays a role. Thus, social media is both a constructor of the crisis as well as an effective tool to resolve it.

#### 4. OBJECTIVES AND RESEARCH QUESTIONS OF THE AUTHOR'S RESEARCH

The main objective of the present part of the research, which was part of the author’s dissertation (Szabóová, 2021), is to *formulate the principles of crisis communication on social networks for people working in advertising agencies*. The partial aim is to *define the main features of crisis communication in advertising agencies on social networks*. The above partial objective is developed by the following 3 research questions:

- **RQ1:** Which crisis communication approach of advertising agencies dominates the social media environment?
- **RQ2:** What preventive tools does an advertising agency apply in crisis management on social media?
- **RQ3:** What are the steps of crisis communication management of advertising agencies in the social media environment in practice?

In order to achieve the above objectives, we applied a mixed strategy, simultaneous combining, namely the QUAL+quan scheme. For data collection, we used an *inquiry method – questionnaire*.

#### 4.1. Characteristics of the Research Sample

The research sample was identical to previous studies published in the crisis communication in advertising agencies series, which were based on the author's dissertation. The sample was drawn by deliberate selection, the selection criterion was clear and strict – the respondent must be professionally active in the creative industry, specifically in an advertising agency. In total, we distributed the questionnaire form to 162 people, with the following composition – we decided to address the request for participation in our research to people who work in agencies that are members of KRAS (Club of Advertising Agencies of Slovakia); we expanded the sample, and we equally addressed people from member agencies of ADMA (Association of Digital Marketing Agencies). We approached 5 people from each agency, always two of them in leading positions. As 3 agencies are members of both KRAS and ADMA, the total was 12 KRAS + 20 (-3) ADMA agencies = 29 x 5 = 145 people contacted (as of June 2021). Based on methodological and research paradigms in which returns are expected to be only around 10% for such highly specialized research, we decided to approach 17 more people from agencies we had worked with in the past, who were not members of any association at the time, as we expected a high return given the good relationships we had. As we expected, the return rate from the first group of agencies, i.e. from ADMA or KRAS member agencies, was 13% (out of 145 respondents, 19 respondents), and the return rate from people from independent agencies was 76.5% (out of 17 respondents, 13 respondents). Thus, in the final analysis, our research sample consisted of 32 respondents (their position in the agency is captured in Chart 1), 11 of whom indicated that they held a senior position in the agency (specifically CEO, Head of Client Services, Head of Account, Creative Director, Managing Director, Art Director). Account managers and social media managers were dominant in the respondent pool, and in our experience in practice, they are the ones who struggle with crisis communication the most (Szabóová, 2021; Števčat Szabóová, 2023).

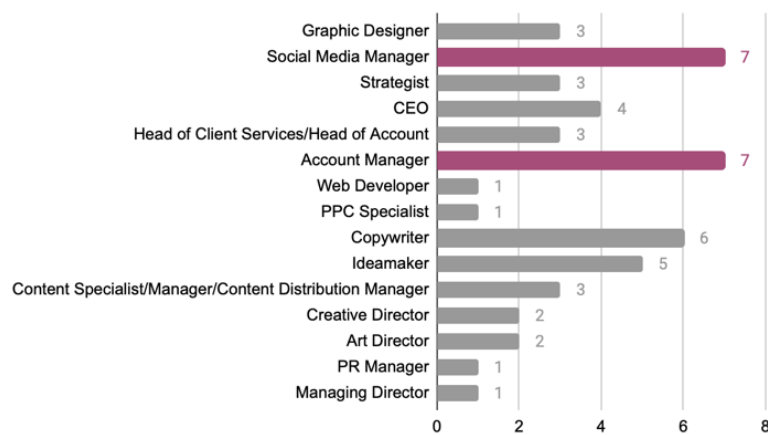

Chart 1: Respondent's Position in the Advertising Agency  
(Source: Szabóová, 2021 in Števčat Szabóová, 2023)

In our scientific article *Crisis Communication in the Creative Industry: Specifics of B2B and B2C Communication of Advertising Agencies* (Števčat Szabóová, 2023), which is also indexed in the Web of Science database, we investigated who is responsible for crisis communication in an advertising agency on social networks, also in the comparison of B2B and B2C communication. In both spheres, the social media manager dominated the responses, with the agency director/CEO and the account manager also appearing among the responses. For CEO, statistical testing confirmed statistical significance, namely that the engagement of the agency

director is significant for the B2B sphere<sup>1</sup>. We explain the above result by the fact that in the *agency-client* (B2B) sphere, the CEO feels threat to their own brand/the agency brand. Whereas, in B2C communication, the client and its brand are at risk.

## 5. RESULTS OF THE AUTHOR'S RESEARCH

### 5.1. Crisis Communication Strategies on Social Media Used by Advertising Agencies

Respondents are most often faced with crisis communication on Facebook, with 43.8 % of respondents communicating on social media on behalf of their agency, i.e. under their own brand and at the same time at the risk of damaging their own image, most often on Facebook. We categorized the strategies or approaches to crisis communication that can be taken on social media into passive and active, where the active form can be explanatory and attempting to resolve or offensive-defensive. The passive approach concentrates on ignoring, playing the “dead bug”. The survey showed that the approach of active efforts to resolve the crisis situation clearly dominates crisis communication in the advertising agency (see Chart 2).

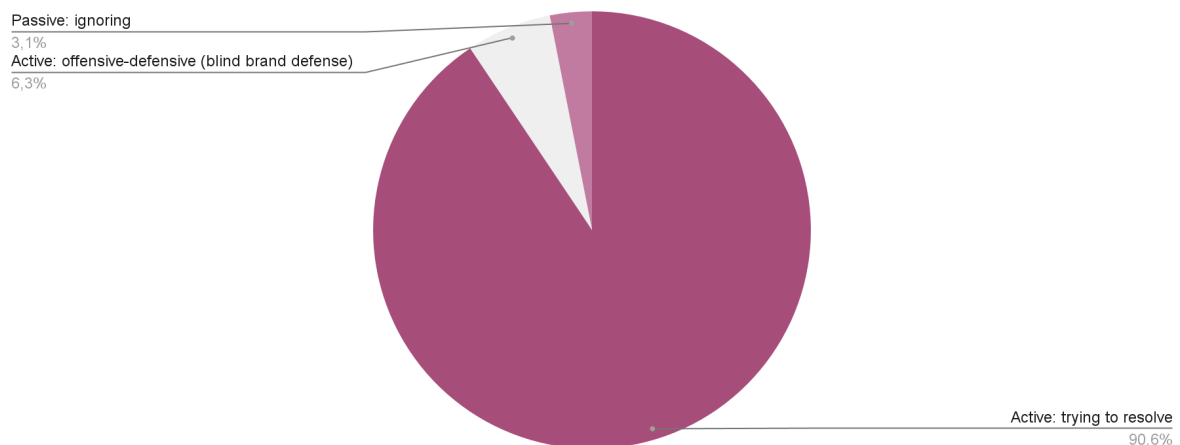

*Chart 2: Crisis Communication Strategies of Advertising Agencies on the Social Network  
(Source: Szabóová, 2021)*

The results shown in the graph are complemented by data from an open-ended question in which people working in an advertising agency were asked to describe in their own words a crisis situation in which they would apply the ignore approach. The majority said that they would not recommend this approach, but if they were to outline a situation in which they would use this passive strategy, it would be a communication containing vulgarities about the agency, about the client, personal attacks and rude swearing, or if they found out that they were dealing with a troll or a robot. Chart 2 indicates that effort to resolve is a fundamental strategy of crisis communication on social media, with up to 38% of respondents mentioning the word “always” or its semantic equivalent in open-ended responses. However, we were also interested in the crisis situations in which they implement a defensive-offensive strategy. It turned out that in situations when it comes to the defense of the weak, in the case of the dissemination of hoaxes, unsubstantiated untruths and obvious injustice that are repeated.

<sup>1</sup> More details on these results in the publication Števčat Szabóová, V. 2023. Crisis communication in the creative industry: Specifics of B2B and B2C communication of advertising agencies In: *Marketing Identity : AI - The Future of Today*. Trnava : University of Ss. Cyril and Methodius, pp. 385-395.

## 5.2. Recommended Principles for Agency Crisis Communications on Social Media

Thanks to the data we collected from the respondents, we formulated a set of recommended practices or principles of crisis communication that should contribute to the effective management of crisis communication on social networks by people working in an advertising agency. However, we would like to state that the formulated recommendations are also suitable for other segments than just the creative industry. Table 3 clearly illustrates the above-mentioned principles.

19 Principles of Crisis Communication for Advertising Agencies on Social Media	
sincerity	transparency
<b>personal, targeted communication</b>	<b>response time/ promptness</b>
<b>avoiding generated responses</b>	relevance of the message
empathy	cool head
avoiding deleting negative comments	thoughtfulness of response (beware of publishing unconsidered conclusions)
ego-free communication	objective approach
<b>neutral communication tone</b> (avoiding a provocative tone)	reasoning with facts
replying to all comments (even negative ones)	agreed strategy (crisis preparedness)
signing comments	<b>an attempt to redirect the conversation from the feed to the private message</b>
influencer involvement	

Table 3: Principles of crisis communication for advertising agencies on social media  
(Source: Szabóová, 2021)

Only by combining all these principles can we contribute to a rapid and favorable end to the crisis. However, the principles that should be emphasized in crisis communication management are in our perception as follows:

- **Response time promptness** – In crisis communication management, response time is key as it can set the flow and especially the narrative of the entire communication. For example, if your company sells a product with a failure, and communicates this itself on its own communication channels or uses an external medium, it can use a regret, an apology, a promise of compensation, which, despite the failure, can elicit understanding and acceptance from the public/stakeholders. However, if your mistake is first pointed out by journalists, a dissatisfied customer, etc., the narrative will be diametrically opposed, e.g. “*company XY is selling poor quality products*”, “*the company is hiding the problem*”, etc., which is a much more difficult starting point for dealing with the crisis as such.
- **Targeted/personal communication** – If you address the customer/client directly, for example by using their name, it gives the impression of more interest in solving their problem. This also goes hand in hand with the recommendation of signing the comment/reply, which gives the feeling of a human communication, not a conversation with a “robot”.
- **Avoiding automatically generated responses** – Automatically generated answers may anger an already dissatisfied customer/client as they are not interested in a templated answer

at the moment but want an adequate and valuable response to their suggestion. For this reason, it is not recommended to include responses such as “*Thank you for your message, we will look into it*” in the comments.

- **Neutral communication tone** – In any type of crisis it is recommended to use a neutral or assertive communication tone, thus it is important to avoid a provocative, snide or ironic style of communication, which could only be an added factor to the continuation of the problem. Not to putting an end to it. Directly related to the above are points such as keeping a cool head, communicating without ego, and being objective.
- **Redirecting the conversation from the noticeboard to a private message** – Asking the social media manager (or other responsible person) to redirect communication from the public noticeboard to a private message is a recommended practice for both minor and major problems, so that communication does not become unnecessarily public and does not grow into a situation that is more difficult to manage.

In the table of principles, we also indicate *the involvement of an influencer* – this strategy is recommended especially in the case of more serious crises, when the brand cannot help itself and needs a third party to improve its image by transferring the influencer’s qualities to the affected brand. Despite the fact that respondents said that they do not recommend deleting negatively disruptive comments and we included this in the principles set, the survey showed that 18.8 % of respondents experienced the opposite approach, i.e. they deleted the comment that posed a risk.

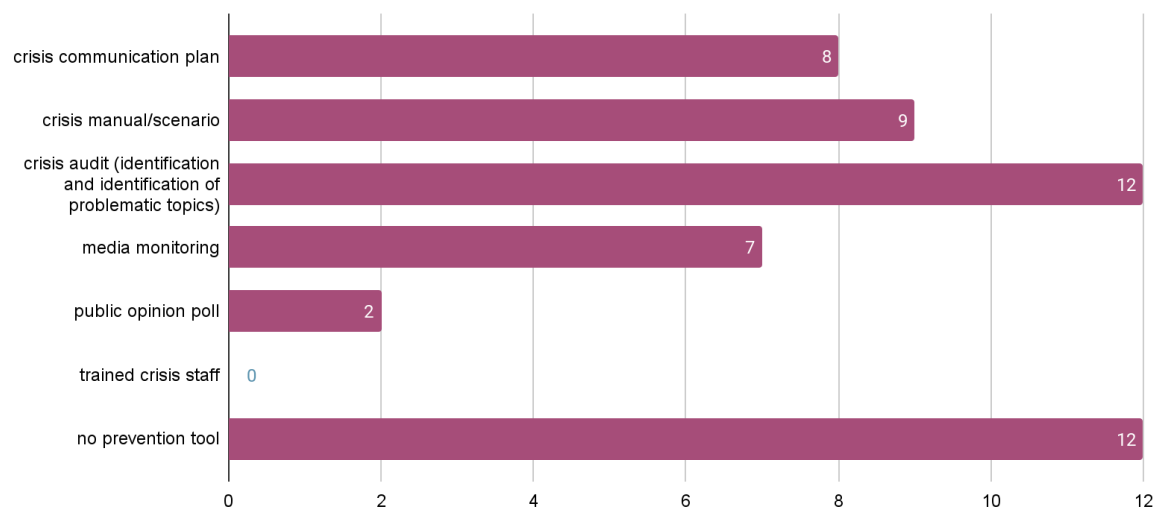

*Chart 3: Prevention Tools Used by People in Advertising Agencies in the Context of Crisis Communication on Social Media*  
(Source: Szabóová, 2021)

Following the recommendation of the agreed strategy, we note that in the context of prevention measures, the results showed that 37.5 % do not use any prevention tool (see Chart 3).

### **5.3. Crisis Communication Management Process of Advertising Agencies in the Social Media Environment**

The process of crisis communication management in an advertising agency can be divided into 5 steps according to the qualitative data of our research, namely: 1) *problem identification*, 2) *strategy creation* (internal meeting or consultation with the client) taking into account whether



it is an objective error or just a subjective opinion of an unsatisfied customer, 3) *creation of supporting documents*, 4) *application of the strategy, or deployment of communication on social media* and 5) *reporting* (evaluation of success). However, the procedure depends on the specific situation, since if it is a minor problem that people in the agency deal with more often or have a manual prepared for it, it is handled individually by the person responsible (usually the social media manager). However, if a new or more complex situation arises, the strategy is created in an internal team meeting or in consultation with the client, where the agency and client set *mantras* together in which they actively communicate until the crisis is resolved. But when can we talk about the end of the crisis? People working in advertising agencies refer to the end of a crisis in the creative industry as the moment when the onslaught of comments stops, when the sentiment of the comments changes from negative to positive, the phase when there are no more attacks. And although the item “*When are you talking about the end of the crisis, or that the crisis is over?*” did not focus the social media framework, the responses were nevertheless directed towards social media which is an evidence of the robust construct of “*crisis communication + social media*” in the minds of those involved in the creative industries; and of the fact that a significant feature of crisis communication in advertising agencies is crisis communication mediated by social media.

## 6. CONCLUSION

At the conclusion of the study, we would like to state that the defined main and partial objectives have been fulfilled and the research questions have been answered. Although people working in advertising agencies use social media in crisis communication management, only 9.4 % of the respondents were familiar with the SMCC Model, a theoretical model that discusses recommended strategies and practices on social media at different stages of a crisis. The given result is also in line with other findings, e.g. that none of the respondents indicated that a crisis staff was trained in their agency. The above corresponds with our earlier conclusion that crisis communication in advertising agencies is intuitive, neither planned nor systematic (Szabóová - Spálová, 2019). Although, as it turns out, people in advertising agencies are usually not educated about crisis communication, they apply their own, usually not pre-planned, procedures, but still they have steps, verified by practice, that work for faster and more effective crisis communication management. As a result, we were able to formulate a set of 19 principles for crisis communication on social media that should help advertising agency staff, but by its nature has universal application in other industries as well. We have highlighted response time, assertiveness and directness in communication, but we have also emphasized that for the most favorable course of crisis communication it is ideal to apply them in combination. Advertising agencies usually follow a 5-step approach to crisis communication management, from identifying the type of crisis to reporting, applying mainly an active approach in the form of explanation. They try to avoid passivity/ignoring and, in the context of prevention and better management of crisis in the social media environment, they mainly use crisis auditing as a preventive tool, in which they try to identify risky topics and problem areas.

**ACKNOWLEDGEMENT:** *This contribution was written as an output of the project UGA IV/5/2024 Crisis Communication in the Practice of Creative Industry: A Profile Through the Lens of PR Agencies (Principal Investigator: Mgr. Veronika Števčat Szabóová, PhD.) and the project VEGA 1/0650/22 Mass Media Communications in Digital and Print Form and Their Comprehension in Different Target Groups (Principal Investigator: prof. Mgr. Katarína Fichnová, PhD.).*

**LITERATURE:**

1. Apuke, O. D. – Tunca, E. (2019). Social media and crisis management: A review and analysis of existing studies In *LAŮ Sosyal Bilimler Dergisi* (roč. 9, č. 2). Retrieved 19.08.2024 from [https://www.researchgate.net/publication/330468226\\_SOCIAL\\_MEDIA\\_AND\\_CRISIS\\_MANAGEMENT\\_A\\_REVIEW\\_AND\\_ANALYSIS\\_OF\\_EXISTING\\_STUDIES](https://www.researchgate.net/publication/330468226_SOCIAL_MEDIA_AND_CRISIS_MANAGEMENT_A_REVIEW_AND_ANALYSIS_OF_EXISTING_STUDIES).
2. Austin, L. – Jin, Y. (2016). Social media and crisis communication: Explicating the social-mediated crisis communication model In *Strategic Communication: New Agendas in Communication*, p. 163-186. Retrieved 20.08.2024 from [https://www.researchgate.net/publication/316488296\\_Social\\_media\\_and\\_crisis\\_communication\\_Explicating\\_the\\_social-mediated\\_crisis\\_communication\\_model](https://www.researchgate.net/publication/316488296_Social_media_and_crisis_communication_Explicating_the_social-mediated_crisis_communication_model).
3. Hejlová, D. (2015). *Public Relations*. Praha: Grada Publishing a.s.
4. Jin, Y. – Austin, L. (2020). Crisis communication and social media: Short history of the evolution of social media ic crisis communication In *Crisis Communication*. Berlín: Walter de Gruyter Inc.
5. Chudinová, E. (2019). *Public Relations I*. Bratislava: Katedra marketingovej komunikácie FF Univerzity Komenského v Bratislave.
6. Přikrylová, J. et al. (2019). *Moderní marketingová komunikace* (2.vyd.) Praha: Grada Publishing.
7. Reputačná kríza na sociálnych sieťach – ako si s ňou poradiť? In *bastadigital.com* Retrieved 31.08.2024 from <https://bastadigital.com/reputacna-kriza-na-socialnych-sietach-ako-si-s-nou-poradit/>.
8. Szabóová, V. (2021). *Krízová komunikácia - optimalizácia komunikačných procesov v krízovom manažmente* (PhD. thesis). Nitra: [V. Szabóová].
9. Szabóová, V. (2019). Crisis Communication in Creative Industries and its staffing In: *Marketing Identity: Offline Is the New Online*. Trnava: University of Ss. Cyril and Methodius, p. 335-352.
10. Szabóová, V. - Spálová, L. (2019). *Crisis Communication in the Creative Industry* Cambridge: Aricon. Retrieved 31.08.2024 from [https://www.academia.edu/122721269/Crisis\\_Communication\\_in\\_the\\_Creative\\_Industry](https://www.academia.edu/122721269/Crisis_Communication_in_the_Creative_Industry)
11. Špoljarić, A. (2021). Managing Crisis Communication Via Social Media In *Naše gospodarstvo/ Our Economy* (roč. 67, č. 1) Retrieved 20.08.1994 from [https://www.researchgate.net/publication/350967862\\_Managing\\_Crisis\\_Communication\\_Via\\_Social\\_Media](https://www.researchgate.net/publication/350967862_Managing_Crisis_Communication_Via_Social_Media).
12. Števcát Szabóová, V. (2023). Crisis communication in the creative industry: Specifics of B2B and B2C communication of advertising agencies In: *Marketing Identity : AI - The Future of Today*. Trnava : University of Ss. Cyril and Methodius, p. 385-395.
13. Vega – Castaneda, L. – Castaneda, M. (2019). *Teaching and learning about difference through social media: Reflection, Engagement, and Self-Assessment*. New York: Routledge.
14. Vlad, D. E. (2020). *Concepts of Quality Connected to Social Media and Emotions*. Wiesbaden: Springer Gablet.

## A PROPOSED METHODOLOGY FOR KNOWLEDGE MANAGEMENT IN TECHNOLOGY-BASED STARTUP

**Marco Antonio Damiao de Mello**  
*Universidade Federal Fluminense, Brazil*  
*Madmello71@gmail.com*

**Stella Regina Reis da Costa**  
*GOVCOPP, Universidade Federal Fluminense, Brazil*  
*stella@ufrj.br*

**David Nunes Resende**  
*GOVCOPP, ESTGA, Universit of Aveiro, Portugal*  
*david@ua.pt*

### **ABSTRACT**

*Startups are pivotal in growing the economy of many countries, generating income, and contributing to social and professional development. However, they frequently encounter unforeseen and recurring failures. The emergence of innovations in various scientific domains and their use by society to address diverse challenges, ranging from agriculture to space exploration, have driven the appearance of new technology-based startups. To stay competitive, companies must rapidly adapt to market shifts, embrace innovation, and enhance performance to ensure business continuity. This article aims to identify and analyze the most used tools by startups for knowledge management to quickly absorb and adapt to market changes and propose a methodology for startup managers who wishes to implement a knowledge management area to better manage their most valuable asset: their Intellectual Capital. In this research, carried out in the exploratory format aligned with its objective, a questionnaire was designed based on a comprehensive review of 121 articles published in the Scopus (Elsevier) database to answer the following question: What tools are used by Technology Startups to capture and disseminate knowledge? The survey was made available to a group of startups based in Brazil and to the startups that participated on the Shell Startup Engine program during the period of October 19, 2022 until December 11, 2023. Evidence have indicated that startup managers need to stay up to date on innovations that effectively address their customers' needs. Artificial Intelligence emerges as a forefront technology-based competitive advantage, but it requires extensive information sharing among everyone involved in the process. The questionnaire results indicate that the startup Intellectual Capital needs to be properly managed via the existence of a Knowledge Management area, the establishment of governance policies and use of technology to protect the company's knowledge repository, particularly regarding to cybersecurity.*

**Keywords:** *Digitalization, Governance, Innovation, Knowledge Management, Startups*

### **1. INTRODUCTION**

Technological innovations are evolving ever faster and influencing everyday human life (SARWONO et al., 2019). The constant transformation of the economic environment, especially in recent times post the COVID-19 pandemic, increase of competition and the precipitation of new technologies are causing concerns in the market, which requires companies to be more agile to quickly adapt to change. Seeking for sustainable performance, startup managers need to keep up to date and know their customers' demands better and meet them (SALEEM et al., 2021). To enhance the results, for example, the use of Artificial Intelligence technologies, such as Big Data systems, which can be accessed in real time, integrating data

can meet the requirements and improve the quality of services and/or products (SAIDE; SHENG, 2020). Knowledge management tools, and technology, are the key drivers to bring competitive advantage to organizations (RACHAPAETTAYAKOM et al., 2020) and allow Small and Medium-sized Enterprises (SMEs) to have greater access to information as well as being able to develop knowledge on subjects relevant to the operation of their business. However, companies are very concerned about selecting inappropriate tools for data analysis, due to their limited knowledge of the solutions available. In addition, many do not have an area dedicated to Knowledge Management, nor clearly defined governance policies for managing this Intellectual Capital, and often do not know where to start this process. The objective of this article is to identify and analyze the most used tools by startups for knowledge management to quickly absorb and adapt to market changes and propose a methodology for startup managers who wishes to implement a knowledge management area to better manage their most valuable asset: their Intellectual Capital.

## 2. METHODOLOGY

The study focuses on mapping the knowledge management tools and method used by technology-based startups to develop, maintain, and utilize their knowledge while ensuring it remains protected and accessible within the organization. The questionnaire was developed through a systematic review of literatures produced about the topic aiming to construct a solid and unbiased understanding of the subject (Mello et al., 2023). The survey was made available to a group of startups based in Brazil and to startups that participated on the Shell Startup Engine program. The survey was conducted from October 19, 2022, to August 11, 2023, obtaining 66 valid responses. This allowed the author to examine different aspects about the topic by considering various trends that have contributed to a deeper understanding about the subject (GIL, 2002). The Graphic 1 presents the Technological Readiness Level (TRL) of the startups with valid responses. The TRL has been widely used as it creates a common understanding of technology, manufacturing, trade, and business in terms of development stages, key elements, and associated risks. In their work (LEE et al., 2019) indicate that early-stage technology-based companies are more susceptible to the impacts caused by constant changes in the external environment.

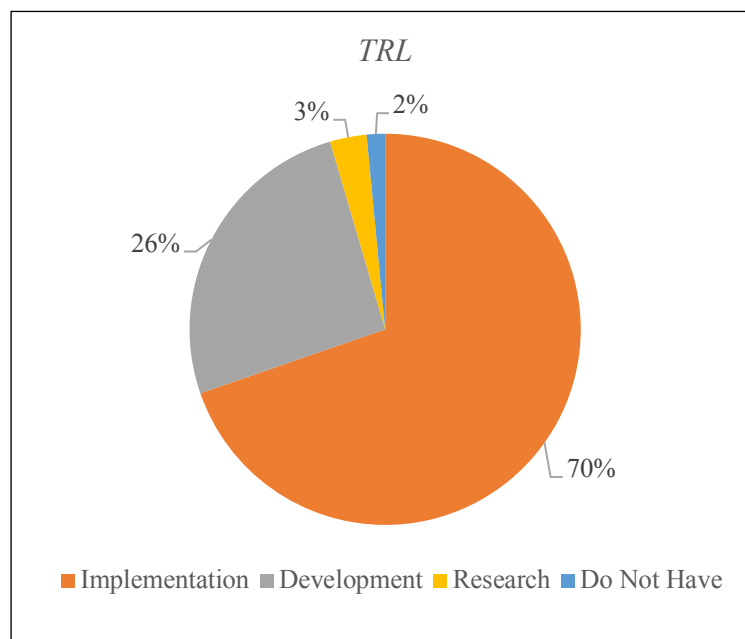

*Graphic 1. Technological Readiness Level (TRL)*  
*Source: Own elaboration (2024)*

### 3. RESULTS AND DISCUSSION

The Graph 2 - Distribution of Articles per Year, illustrates the number of articles published annually within the search scope. In 2023, there was a significant increase in publications in 2023, with data for 2024 extending only up to August. The trend shows a growing number of publications since 2020, nearly doubling by 2023, highlighting the importance of the subject.

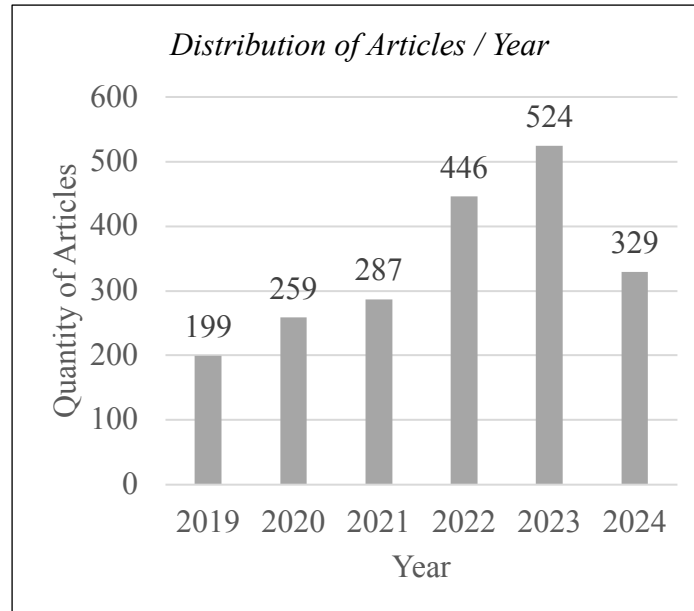

*Graphic 2. Distribution of Articles per Year*  
*Source: Own elaboration (2024)*

In Graphic 3, it is possible to find the fifteen countries that have published the most articles on the researched theme. China can be seen as the leading producer of papers, more than two times of the second highest country. This suggests that China acknowledges the relevance of knowledge management to support innovation and competitive advantage.

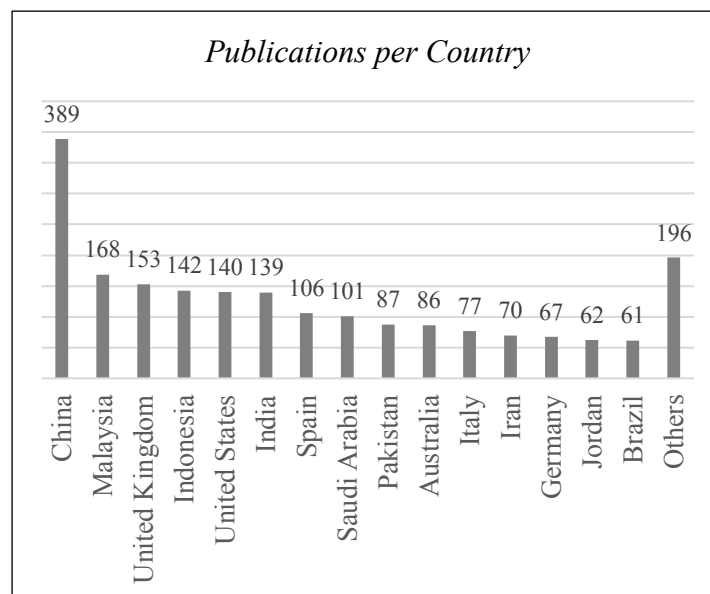

*Graphic 3. Number of publications per Country*  
*Source: Own elaboration (2024)*

#### 4. A CRITICAL ASSESSMENT OF LITERATURE REVIEW CORRELATED TO THE RESEARCH OBJECTIVES

For the company, it is crucial to quickly embrace and adopt new technologies in a volatile digital market to remain updated and continuously maintain technical expertise (RACHAPAETTAYAKOM et al., 2020). However, it can be seen in Graph 4 that only thirty-three percent of the 66 startups that answered the survey said they Totally Agree that the company has a dedicated Knowledge Management area that develops, captures, records and shares knowledge on a regular and constant basis.

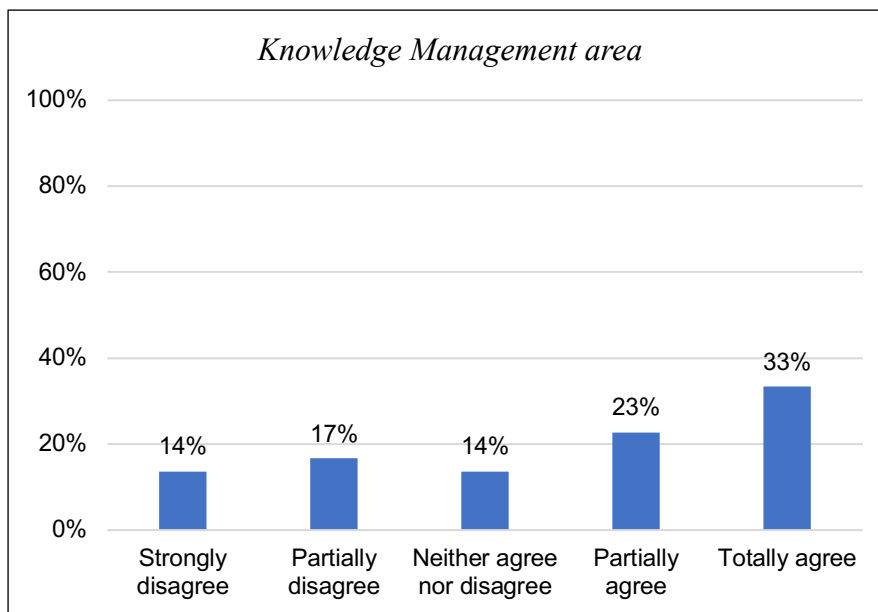

Graphic 4. Dedicated knowledge management department.  
Source: Own elaboration (2023)

Cloud computing services provide a cost-effective and easily accessible infrastructure that allows companies to safely store and keep track of the knowledge repository, which is vital for companies to foster rapid and continuous digital innovation. It is vital for startups due to their need to collaborate with external actors, as co-creation in various forms with partners is essential to their development process. Startups tend to promote an agile culture, where communication and collaboration take place more informally and where digital tools can improve relationships, making people feel safe and openly trusting each other like a sounding board on a chat channel for quick knowledge exchange and effective collaboration for continuous learning (LIU et al., 2020). The key here seems to be simplicity, delivering significant value to customer by providing the necessary means for collaboration regardless of location and subscription as a business model with no lock-in effect. As for example the approach that many tech giants like Spotify, Salesforce, Twitter, Slack seem to apply when, for example, they recently launched a new work policy with innovative programs where people can work from anywhere. In general, the concept of using Big Data to gain deeper insights into customer desires was well accepted (LIU et al., 2020). According to Graph 5, knowledge management tools is essential important/fundamental for 81% of respondents who 'totally agree + partially agree'. This consensus reinforces the importance of knowledge management tools to foment the usability of a company's digital tools. Knowledge management topic has attracted significant attention from researchers and organizations because it is an important business management tool that allows startups to gain a competitive advantage (RAMDANI et al., 2020).

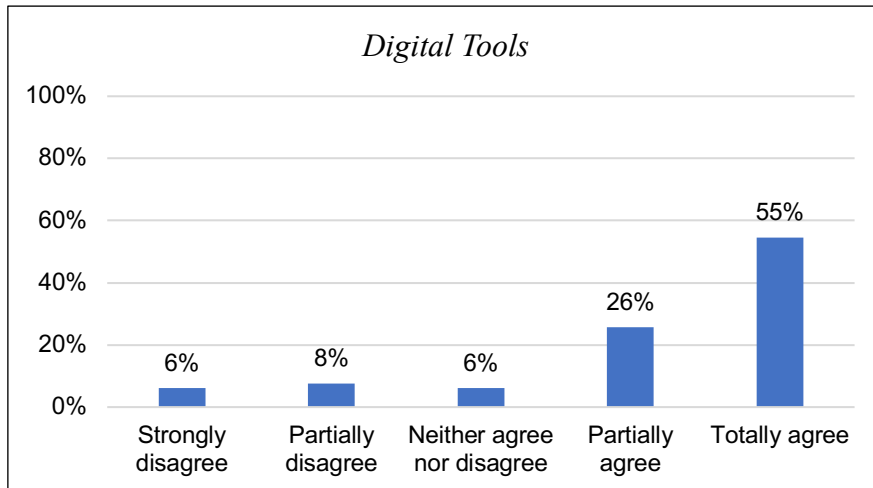

*Graphic 5. Digital Tools for Knowledge Management.  
Source: Own elaboration (2023)*

Governance policies in startups, to manage the knowledge produced and acquired by the company, have gained visibility in organizations as a possible way of meeting the expectations of top management (RAMDANI; RAJA; KAYUMOVA, 2022). For the authors, Governance involves both the strategic and institutional aspects of the organization, especially in the relationship between Information Technology and its stakeholders. Therefore, the company plays a pivotal role in the process of guaranteeing transparency regarding the organization's information, responding to the demands of the external and internal agents involved. According to Graph 6, seventy percent of employees agree that governance must be fundamental for the company's values to flow.

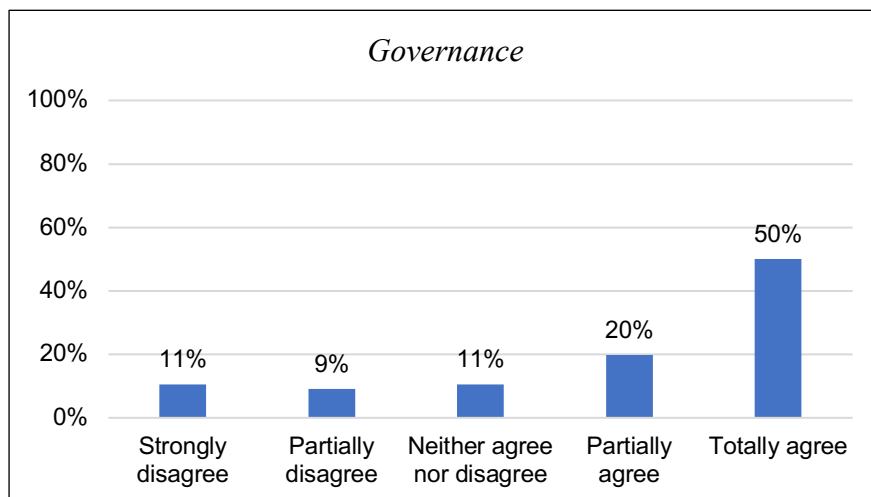

*Graphic 6. Governance policy to handle information/knowledge.  
Source: Own elaboration (2023)*

## **5. A PROPOSED METHODOLOGY FOR KNOWLEDGE MANAGEMENT IN TECHNOLOGY-BASED STARTUPS**

The methodology described in Figure 1 proposes the implementation of knowledge management through three key dimensions: Governance, Knowledge Management and Open Innovation. The foundations elements (Processes, Tools and People) are crucial for sustaining the overall process. This approach aims to capture, document, and disseminate the knowledge generated by the company throughout its operations.

By doing so, the company can better understand market demands, adapt to competitive changes, and refine its business model to ensure continued success.

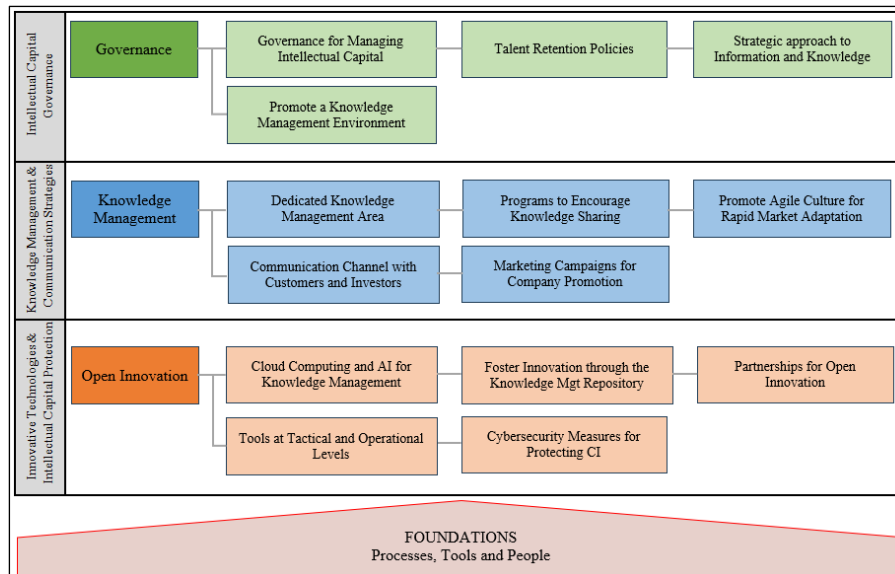

Figure 1. Methodology for knowledge management

Source: Own elaboration (2024)

With regards to Governance, the company needs to establish and maintain a safe environment to protect and guarantee access to the knowledge generated by its teams. Safeguarding the company's Intellectual Capital through robust policies and effective governance is essential for maintaining competitiveness and ensuring agility in adapting to new market conditions, as well as correctly and promptly interpreting the wishes of its customers. According to the concepts of Agile methods, failing early is important, but even better is succeeding early based on the knowledge and lessons learned along the way. In the dimension of Knowledge Management, it is important to stimulate relationships with external stakeholders, such as universities, governments, companies and investors. The involvement with external agents will generate opportunities and help the company's potential to evolve. Promote the company via the correct channels is relevant to maintain its reputation in the market improving the chances to attract new investors and customers. Regarding to Open Innovation, Industry 4.0 technologies, such as Artificial Intelligence and Cloud Computing, can offer secure and reliable solutions for managing the company's knowledge repository, especially relating to cyber security. The foundations focus on developing and implementing standardized procedures, utilizing tools to ensure access to the company repository, and continuously investing in people, who are the most crucial element in knowledge sharing. The proposed methodology is intended for managers of startups, or to any company or institution seeking to establish a knowledge management area to better manage its Intellectual Capital to foster development and innovation. This methodology is based on the studies and findings presented in this paper, as well as on the outcome results of the research conducted with startups mentioned in the Methodology session. It is designed to be flexible, without a fixed sequence or timeline, and can be adapted to the specific needs and realities of each organization.

## 6. CONCLUSION

This work has successfully addressed the main question of this research, "What tools are used by Technology Startups to capture and disseminate knowledge?", by identifying the most common tools used by the startups to manage the knowledge generated and captured,



emphasizing its relevance to enable the company to quickly adapt to the changes imposed by the market. The findings have indicated the importance of tools to stimulate and facilitate the information sharing between the teams, and with the external environment, as well as of a knowledge repository to safely store the company Intellectual Capital, such as the Cloud Computing. Moreover, the proposed methodology provides a structured approach for the startups to implement a Knowledge Management area to manage their Intellectual Capital to remain competitive and prosper. The methodology emphasizes the foundations and key dimensions to be considered when implementing a knowledge management area. Future research could further investigate the effectiveness and outcomes of the proposed methodology implementation, in addition of the long-term impacts of the tools described in this work. This would provide a deeper understanding and refinement of best practices in knowledge management.

**ACKNOWLEDGEMENT:** *This work was financially supported by the research unit on Governance, Competitiveness and Public Policy (UIDB/04058/2020)+(UIDP/04058/2020), funded by national funds through FCT - Fundação para a Ciência e a Tecnologia.*

#### LITERATURE:

1. ALVAREZ, J. et al. *Proposta de política de ciência, tecnologia e inovação baseada na gestão do conhecimento para um cluster de pequenas empresas de energia solar*. Revista Ibérica de Sistemas e Tecnologias de Informação, n. E37, p. 65–77, 2020.
2. BAI, S.; ZHAO, Y. *Startup Investment Decision Support: Application of Venture Capital Scorecards Using Machine Learning Approaches*. Systems, v. 9, n. 3, p. 55, 22 jul. 2021.
3. CASEIRO, N., & COELHO, A. (2018). *Inteligência de negócios e competitividade: o papel mediador da orientação empreendedora*. Competitiveness Review, 28(2), 213-226. <http://dx.doi.org/10.1108/CR-09-2016-0054>
4. CAUCHICK, Paulo, et al. *Elaboração de artigos acadêmicos: estrutura, métodos e técnicas*. Elsevier Brasil, 2017.
4. FERENHOF, H. A.; FERNANDES, R. F. *Desmistificando a revisão de literatura como base para redação científica: método SFF DEMYSTIFYING THE LITERATURE REVIEW AS BASIS FOR SCIENTIFIC WRITING: SSF METHOD*. Revista ACB, v. 21, n. 3, p. 550–563, 2016.
5. GANGULY, A. et al. *Firms' Reputation for Innovation: Role of Marketing Capability, Innovation Capability, and Knowledge Sharing*. Journal of Information & Knowledge Management, v. 19, n. 02, p. 2050004, 14 jun. 2020.
6. GIL, A.C. (2002) *Como elaborar projetos de pesquisa*. 4a ed. São Paulo: Atlas S/A.
7. GRAY, David. E. *Pesquisa no mundo real*. Porto Alegre: Penso, 2012.
8. HASHIMY, L.; TREIBLMAIER, H.; JAIN, G. *Distributed ledger technology as a catalyst for open innovation adoption among small and medium-sized enterprises*. The Journal of High Technology Management Research, v. 32, n. 1, p. 100405, maio 2021.
9. HERMAWATI, A.; GUNAWAN, E. *The implementation of dynamic capabilities for small and medium-sized enterprises in creating innovation*. VINE Journal of Information and Knowledge Management Systems, v. 51, n. 1, p. 92–108, 13 fev. 2021.
10. HIGGINS, J. P. T.; GREEN, S. (editors). *Cochrane Handbook of Systematic Reviews of Intervention*. Version 5.1.0. London: The Cochrane Collaboration.
11. HIL, A. M. et al. *Cryptonight mining algorithm with yac consensus for social media marketing using blockchain*. Computers, Materials and Continua, v. 71, n. 2, p. 3921–3936, 2022.

12. HUANG, Z. XIONG; SAVITA, K. S.; ZHONG-JIE, J. *The Business Intelligence impact on the financial performance of start-ups*. Information Processing and Management, v. 59, n. 1, p. 102761, 2022.
13. JORDÃO, R. V. D.; NOVAS, J.; GUPTA, V. *The role of knowledge-based networks in the intellectual capital and organizational performance of small and medium-sized enterprises*. Kybernetes, v. 49, n. 1, p. 116–140, 21 jan. 2020.
14. LIU, Y. et al. *Cloud-based big data analytics for customer insight-driven design innovation in SMEs*. International Journal of Information Management, v. 51, p. 102034, abr. 2020.
15. MARCONI, Mariana de Andrade; LAKATOS, Eva Maria. *Metodologia do trabalho científico*. 7 ed. São Paulo: Atlas, 2008.
16. MELLO, Marco Antonio Damiao De; COSTA, Stella Regina Reis Da; RESENDE, David Nunes. *A systematic literature review of knowledge management applied to technology-based startups: state-of-the-art and trends*. In: INTERNATIONAL SCIENTIFIC CONFERENCE ON ECONOMIC AND SOCIAL DEVELOPMENT, 95., 2023, Aveiro. Anais [...]. Aveiro: Economic and Social Development, 2023.
17. RACHAPAETTAYAKOM, P. et al. *The need for financial knowledge acquisition tools and technology by small business entrepreneurs*. Journal of Innovation and Entrepreneurship, v. 9, n. 1, p. 25, 14 dez. 2020.
18. RAMDANI, B.; RAJA, S.; KAYUMOVA, M. *Digital innovation in SMEs: a systematic review, synthesis and research agenda*. Information Technology for Development, v. 28, n. 1, p. 56–80, 2022.
19. ROSS, G. et al. *CapitalVX: A machine learning model for startup selection and exit prediction*. The Journal of Finance and Data Science, v. 7, p. 94–114, nov. 2021.
20. SAIDE, S.; SHENG, M. L. *Toward Business Process Innovation in the Big Data Era: A Mediating Role of Big Data Knowledge Management*. Big Data, v. 8, n. 6, p. 464–477, 1 dez. 2020.
21. SALEEM, H. et al. *Big data use and its outcomes in supply chain context: the roles of information sharing and technological innovation*. Journal of Enterprise Information Management, v. 34, n. 4, p. 1121–1143, 15 jul. 2021.
22. SARWONO, R. et al. *IT governance of the business incubator service: Startup readiness level*. ICIC Express Letters, v. 13, n. 9, p. 841–849, 2019.
23. TASSABEHJI, R.; MISHRA, J. L.; DOMINGUEZ-PÉRY, C. *Knowledge sharing for innovation performance improvement in micro/SMEs: an insight from the creative sector*. Production Planning & Control, v. 30, n. 10–12, p. 935–950, 10 set. 2019.
24. RUNYAN, RC *Pequenas empresas diante da crise: identificando barreiras para a recuperação de um desastre natural*. J. Gestão de Crise de Contingências. 2006, 14, 12–26.

# THE INFLUENCE OF SOCIAL MEDIA PLATFORMS ON ONLINE SHOPPING BEHAVIOUR AND CONSUMER DECISION-MAKING PROCESS

**Marina Gregoric**

*Rhine - Waal University of Applied Sciences, Kleve, Germany  
marina.gregoric@hochschule-rhein-waal.de*

**Sebastian Nowik**

*Rhine - Waal University of Applied Sciences, Kleve, Germany  
sebastian@nowik.org*

**Philipp Schorn**

*Rhine - Waal University of Applied Sciences, Kleve, Germany  
Philipp.Schorn@hochschule-rhein-waal.de*

## **ABSTRACT**

*The internet and social media are increasingly influencing people's everyday lives. Understanding how social media platforms influence online shopping behaviour and consumer decision-making processes is paramount. As a result of worldwide purchasing products online, consumers can become very vulnerable to being influenced by social media to buy a product directly. With tactics like targeted advertisements and influencer marketing frequently used by companies to convince consumers to buy their products or services, marketers must understand how this can be accomplished, to what extent consumers can be influenced, and if companies need to promote products online. This research paper aims to provide a comprehensive understanding of how and to what extent social media, their users, and influencers influence the consumer's behaviour and decision-making process and how it increases brand awareness. The research results elaborate on the factors playing an important role in influencing consumer behaviour and the decision-making process. Additionally, the research explores how this behaviour and the decision-making process are being altered by social media. The methodology used in this research paper, which includes secondary data analysis, historical method, analysis, comparison, and primary research using quantitative empirical research, was chosen for its ability to provide a comprehensive understanding of the topic. The quantitative research was used to evaluate whether consumers' behaviour and decision-making process were and still are being altered in ways that could confirm that social media indeed influences consumers with its multiple aspects. This research paper elucidates the practical implications of how companies can implement different promotional and advertising techniques and which factors are essential to understanding and maximizing promotional activities using social media. By understanding these implications, companies can make decisions and effectively leverage social media for their promotional activities.*

**Keywords:** *consumer behaviour, decision-making process, influence, marketing, social media advertising*

## **1. INTRODUCTION**

A significant evolution of a phenomenon is the development of social media and its impact on consumer behaviour, which has been seen over the past decade (Jamil et al., 2022, p.1). Personal communication has been transformed by various platforms and has become a pivotal tool for brands in marketing their products (Jamil et al., 2022, p.1). As mentioned by Jamil et al. (2022), a lot of different social activities have been brought to the virtual world from the real world thanks to social networking sites (SNS) (p.1). Since messages are also being sent directly

to other people, the instantaneous sharing of information and interaction between people has been enabled for consumers, due to this, these social media platforms are seen by organizations as crucial tools to succeed in the online marketplace (Jamil et al., 2022, p.1). As stated by Rosário & Dias (2023), from a business perspective, relationships can be formed, experiences can be developed, and interactions can be enabled between them and the customers, thanks to these social media platforms with which purchasing decisions can be promoted by companies (p.1). This directly indicates that consumer behaviour can be influenced by these social networking sites (Rosário & Dias, 2023, p.2). Researchers showed that these SNSs are continuously influencing different aspects of people's lives, for example, their social life, their educational activities, their political perspectives, but also, in this context, most notably their business and commercial lives (Rosário & Dias, 2023, p.2). Therefore, these changes created a considerable opportunity for companies to market their products and services to their customers by enhancing their involvement and communication (Rosário & Dias, 2023, p.2). However, here, as Rosário & Dias (2023) have mentioned, the judgment of consumers has been shifted by the proactive consumer communication from "[...] valuing firm-based promotions to peer opinions and recommendations[...]" (Rosário & Dias, 2023, p.2). This then raises the question of how far consumers are being influenced by social media, its influencers, and companies. How are consumers being influenced by these social networking sites? The following will analyze this.

## **2. FACTORS INFLUENCING DECISION-MAKING**

To fully understand how social media and the corresponding factors influence the consumer, it is crucial to understand which factors influence decision-making and consumer behaviour. There are various presumptions as to what the intentions of people to buy products online are; one of these is the fact that products are often purchased by people not because of their primary function but for a value that may be subjectively perceived, meaning that not only the primary function is seen as important to the buyer, but that nowadays the simple usage limits of a product are being exceeded by it (Stávková et al., 2008, p.276). Very often, it is not only decided by the consumer after seeing the main utility provided by the product to purchase it, but after the particular product qualities have been noted and also after the extended product has been seen, which shows the intangible factors that are being offered by the product by which the consumer is given the perceived advantage, these can be the image of the company, consultancy in the purchase process, after-sale service, and more (Stávková et al., 2008, pp.276-277). This shows that consumer behaviour and decision-making processes are influenced by various factors (Stávková et al., 2008, p.277). These factors can be distinguished into multiple types, the first one being personal factors (Stávková et al., 2008, p.277). Personal factors are unique for each consumer. Things like age, sex, place of residency, occupation, economic conditions, personality, and self-consciousness are included here (Stávková et al., 2008, p.277). Age has a potential impact on consumer behaviour due to consumers' changing needs over the course of their lives (GAJJAR, 2013, p.12). A significant impact on buying behaviour and the decision-making process is also had by the occupation of a consumer (GAJJAR, 2013, p.12). The economic situation of a consumer also plays an important role, since when a higher income and more savings are had by a consumer, expensive products are more likely to be bought by them, while expenses might need to be cut back by a person with lower income and savings (GAJJAR, 2013, p.12). Here, other incomes play into the decision-making, not only is individual income important, but a substantial role in consumer behaviour and decision-making can be had by family income, consumer credit, income expectations, and many more (Ramya & Ali, 2016, p.79). The second factors are psychological, motivation, skills and knowledge, perception, personality, and lifestyle are included by these (Stávková et al., 2008, p.277). In this context, perception means the adaption of reality, the process of the data given being decided on,

processed, and interpreted to make it have a purpose (Stávková et al., 2008, p.277). In regards to motivation, every person has different needs. Some of these needs might be perceived as more important by a person than other needs, resulting in them becoming a motive and the motivation for this good to be bought (GAJJAR, 2013, p.12). Personality is created by the characteristics and behaviour of the consumer, the things that make a person unique (Stávková et al., 2008, p.277). It is the totality of a person's behaviour in various circumstances (GAJJAR, 2013, p.12). Lifestyle can also simultaneously be a personal factor, it is the way a person lives in a society and how this person expresses themselves in their surroundings (GAJJAR, 2013, p.12). However, another psychological factor can be a person's beliefs and attitudes towards a product (GAJJAR, 2013, p.12). The brand image is made up of these beliefs and attitudes, and therefore, consumer purchase behaviour and decision-making process are also heavily affected by these (GAJJAR, 2013, p.12). A purchase decision can also be heavily influenced by situational factors (Stávková et al., 2008, p.277). Here, a considerable role is played by the purchase place, physical environment, time, and social environment when it comes to decision-making (Stávková et al., 2008, p.277). Also, consumer behaviour is heavily influenced by cultural factors such as buyer culture, subculture, and social class (GAJJAR, 2013, p.11). As it has been stated by Ramya & Ali (2016): "Culture influences considerably the pattern of consumption and the pattern of decision-making." (p.79). Consumer behaviour is also influenced by social class (GAJJAR, 2013, p.11). Yet here, it needs to be noted that social class is not solely determined by income; each individual's consumer behaviour is influenced by other factors like wealth, education, and occupation (GAJJAR, 2013, p.11). As aforementioned, the decision-making process can be influenced by the social environment and social factors, here, important factors are family, role, status, and reference groups (GAJJAR, 2013, p.11). A person's consumer and buying behaviour could be indirectly influenced by the family (GAJJAR, 2013, pp.11-12). Roles and status are a part of every person in society. These are dependent on the groups, organizations, families, clubs, etc., to which they might belong, resulting in different influences from different groups regarding their decision-making process and consumer behaviour (GAJJAR, 2013, p.12).

### **3. THE INFLUENCE OF SOCIAL MEDIA ON CONSUMER BEHAVIOUR**

After seeing which factors play an important role in influencing the consumer decision-making process, it is important to see how social media alters this process and consumer behaviour. Social influence is an area of research in communications and consumer behaviour that has become very important, traditionally, this social influence in consumer behaviour has been conceived as Word-of-mouth communication (Humphreys, 2017, p.371). Word-of-mouth is the non-commercial communication between two consumers where marketing information can be exchanged in a way where a person's behaviour can be shaped where their attitude toward a product, brand or service can be changed (Buttle, 1998, p.242; Huete-Alcocer, 2017, p.1). These can be reviews, ratings, ratings of ratings, comments, and more (Humphreys, 2017, p.371). This results in different aspects of consumer behaviour being strongly influenced by social media and word-of-mouth (Humphreys, 2017, p.372). Not only can consumers be affected, but also companies' sales or stock prices can be affected (Humphreys, 2017, p.372). It is also shown that more influence is had by word-of-mouth than mass media messages and that reviews are trusted more by customers than advertising of the companies (Humphreys, 2017, p.372). This is due to the source being perceived by consumers to be more like themselves (Humphreys, 2017, p.372). Yet, the consumer decision-making process is strongly influenced by WOM, and these ratings do not necessarily have to reflect product quality (Humphreys, 2017, p.372). Instead, online word-of-mouth is shaped by experience, which can be extremely diverse by price and brand image (Humphreys, 2017, p.372). Companies have also been given an advantage over traditional WOM by electronic WOM, with them being able to see and try to understand by

which factors consumers are being motivated by their opinions or reviews being posted online (Huete-Alcocer, 2017, p.2). The company can be profiled positively when they are providing a good product or great customer service, or this way of consumers being informed by each other can become a factor that cannot be controlled by the company (Huete-Alcocer, 2017, p.2). Therefore, Word-of-mouth is being viewed by companies as a new opportunity for their customers' needs and wants to be listened to so the way their products and services can be adjusted for their customers' needs and wants to be fulfilled (Huete-Alcocer, 2017, p.2). The customers' future purchase intentions will be influenced by either negative or positive feelings towards the product, service, or company, ultimately altering their consumer behaviour (Huete-Alcocer, 2017, p.2). The most defining elements of online word of mouth are valence, the negative or positive nature of reviews; variance, the diversity and range of opinions expressed; and volume, the quantity or amount of feedback (Humphreys, 2017, p.372). Valence and volume have the most significant influence on purchasing decisions due to positive or negative reviews and the ability of the number of reviews to heavily alter one's perception of a product (Humphreys, 2017, p.372). Due to the advanced variety and enhanced amount of information that is being offered by the internet online, the ability of better consumption choices to be made by consumers has improved, and new opportunities for information search have been given due to low search cost (Voramontri & Klieb, 2019, p.216). Yet, most of the time, the results in search engines are often dominated by user-generated content, reviews, and their opinions (Voramontri & Klieb, 2019, p.216). It has also been stated by Voramontri & Klieb (2019) that social media is mainly used by consumers for the benefit of quick and direct access to information at their convenience, then being given the possibility to decide what to buy or to gain more knowledge about new brands and products (p.216). A 'participatory culture' has been brought on by the trend of users networking with other like-minded individuals via social media, where an unending loop of information being shared, updates being monitored, and opinions on various products, services, activities, etc., being requested, is being engaged in by people (Ashman et al., 2015, p.129). It has also been stated by Zhang et al. (2014) that the consumer will be positively assisted by reviews of better quality when purchasing decisions are being made by the consumer, factors such as source credibility, perceived quantity of reviews, and the quality of the argument to buy a product, are all important determinants of behavioural intention (p.85). As aforementioned, it is also stated that consumers are influenced by the ranking level of reviews and the number of reviews (Zhang et al., 2014, p.85). If credible reviews are found by the potential buyer, their purchase intention can be increased, same as with the number of reviews, due to products with many online reviews being bought more likely by consumers rather than products with only a couple of reviews (Zhang et al., 2014, p.85). Consumers see social media as a more trustworthy source of information than traditional media, corporate communications, and advertisements (Voramontri & Klieb, 2019, p.216). Nowadays, organizations can design and develop ads in more creative and innovative ways. This is important because social media platforms provide consumers with new and different experiences, which bring them more joy and entertainment. This can lead to them being influenced into purchasing a product due to a hedonic motivation (Alalwan, 2018, p.73). A record of individual consumer's online activities, interests, preferences, and communications over time and across multiple different websites is collected and compiled by companies (Zhu & Chang, 2016, p.442). Thanks to that, these organizations can send particular and personalized advertisements to individuals (Zhu & Chang, 2016, p.442). This personalized and targeted advertising trend became very popular in online retailing (Zhu & Chang, 2016, p.442). It has been stated by Alalwan (2018) that when customers are feeling social media ads that the ads are related to their preferences and interests, the probability of the product advertised being bought by them is higher (p.73). Therefore, consumer behaviour is more influenced by social media ads when a consumer's lifestyle, characteristics, needs, and interests are targeted, and the

ads are personalized towards these, due to them then being perceived as more useful (Alalwan, 2018, p.73). This interconnection between perceived relevance and the resulting consumer behaviour is essential (Alalwan, 2018, p.73). Currently, customers see two-way communication as more attractive than just receiving messages (Alalwan, 2018, p.72). Therefore, if a consumer perceives a higher level of interactivity regarding social media advertising, the chances this ad will be seen as more useful and entertaining to follow are greater. Accordingly, their motivation to purchase the product or service displayed by the ad will be higher (Alalwan, 2018, p.72). Various advertisers and companies have used celebrities to increase awareness or perception of the brand for quite some time now, the reason being that celebrities, who are looked upon, are usually trusted by people (Bognar et al., 2019, p.304). The concept of influencer marketing is very similar. However, here, not solely famous TV personalities, musicians, film stars, etc., from traditional media are being used by marketers. Still, celebrities from social networks are being used as so-called social media influencers (Bognar et al., 2019, p.304). Here, influencer marketing is used to spread a particular message or trend online as sponsored content by these influencers to their followers and the targeted audience (Bognar et al., 2019, p.305). Here, it also has been stated by Bognar et al. (2019) that advertised messages by influencers are perceived by consumers as convincing and more reliable, particularly when a high number of followers on social networks is had by the influencer (p.305). Therefore, these influencers can be used as mediators by the companies as to how the target audience the brand intends the product to advertise for can be connected with, that way, the probability of the product being bought by followers that already trust the influencer is more significant (Bognar et al., 2019, p.305). Whether the consumer's perception of a product due to an influencer promoting it now being changed, thereby getting motivated for a quick decision to be made when buying, has been proven by Bognar et al. (2019) that influencer's recommendations are indeed reacted to significantly more by consumers, therefore their decision-making process being influenced and altered (p.308). So, to conclude, people can be influenced by social media in various ways, from being socially influenced through online word-of-mouth on social media sites (Humphreys, 2017, p.371) to actively being influenced through specific advertisements by organizations (Alalwan, 2018, pp.72-73). Purchasing behaviour is greatly influenced by WOM, the amount and quality of reviews and the decision-making process are also altered by these factors (Humphreys, 2017, p.372; Zhang et al., 2014, p.85). Here, online communities and social media networks also play a big role in social support being given while it is being decided whether a product will be purchased (Riaz et al., 2021, p.109). Influencing through social media can even go as far as consumers being targeted and influenced by influencers and their opinions (Bognar et al., 2019, pp.304-305). On top of that, consumers often use social media as an information source and is often trusted because it is easily accessible (Voramontri & Klieb, 2019, p.216).

#### **4. RESEARCH METHODOLOGY**

The research method and quantitative research will be elaborated on, as will the purpose, strategy, data collection, sample selection, and data analysis (Saunders et al., 2016). This research aims to explore and gain further knowledge on how consumer behaviour and the decision-making process might be influenced by social media and the corresponding factors, making it an exploratory study (Saunders et al., 2016, pp.174-175). Here, a literature review has been done previously for first knowledge about the topic to be gained, to understand what it consists of, how a consumer might get influenced, etc., yet for even more knowledge to be gained, quantitative research was conducted, in which also the W-questions might be answered (Saunders et al., 2016, p.175). But, due to already having first insight after the literature review, certain causal relationships between different factors could be brought up by the following research, like the degree of a consumer's social media usage and the degree to how strongly this person might be influenced by it, making it an explanatory study to a certain degree (Saunders

et al., 2016, p.176). Therefore, this research purpose and study can be called a combined study of exploratory and explanatory studies (Saunders et al., 2016, p.176). The research strategy that was chosen for the quantitative research was a survey, in which the W-questions might be answered, this was done due to its simplicity for every user (Saunders et al., 2016, p.181). Nevertheless, this particular survey is not only quantitative but also qualitative, due to not only quantitative questions but also qualitative questions being asked within the survey by which personal experiences can be shared for further personal knowledge to be given by the participants, similar to interview questions (Saunders et al., 2016, p.165). Here, the quantitative questions will outweigh the qualitative questions therefore, the quantitative research method will have the dominant role, with the qualitative questions simply further insights into personal scenarios will be given which might reflect the outcomes of the conducted survey or the outcomes of the literature review, possibly also leading to the outcomes being confirmed and strengthened (Saunders et al., 2016, p.172). The time horizon of this study was roughly one month long, until 100+ participants were gathered, and was evaluated at the end of it after reaching this number, making it a cross-sectional study (Saunders et al., 2016, p.200). Another aspect is the credibility, reliability, and validity of the study. Due to the researcher being known personally by most of the participants, answers may be shown that might be influenced by the relationship with the researcher, showing participant bias (Saunders et al., 2016, p.203). Also here, further participant bias might be seen regarding the participants' answers due to the possible fear of being judged by their answers (Saunders et al., 2016, p.203). Furthermore, possible participant errors could occur due to the study being in English and with most of the participants being Germany-based or from other countries in which English is not the main language spoken, for example, Italy and Poland, most of the participants are non-native speakers regarding the English language, therefore making the possibility of misunderstandings arise with specific questions (Saunders et al., 2016, p.203). Regarding validity, the further quantitative research outcomes will underline that. Indeed, social media is being used by a large number of people, and products or services are being purchased by a large number of people online. In regards to data collection, a questionnaire has been used, specifically an online Google questionnaire (Google Forms). Also here, the questionnaire has been used in a mix of methods as aforementioned, due to the outcomes of the questionnaire then being put in relation with the outcomes of the previously done literature review, and the qualitative questions then also further supporting or debunking the findings of the quantitative questions and the outcome of the literature review (Saunders et al., 2016, p.439). This research was also designed so that no of the participants would be or feel insulted, for it to be ethically correct and respectful towards the participants, while also ensuring anonymity due to personal information like their government names not needing to be disclosed.

## **5. DISCUSSION – INTERPRETATION AND IMPLICATIONS OF THE FINDINGS**

To properly assess whether consumers are being influenced by social media for their behaviour and decision-making process to be altered, all of the quantitative research outcomes and results will be compared to the previously examined literature. Thanks to this, the outcomes of whether consumers are being influenced by social media and to what extent their consumer behaviour and decision-making process can be altered will be explained. Also, future implications for practice will be explained. A total of 112 participants were observed to take part in the survey, of which roughly 35-70 were also seen to have answered the open qualitative questions, which were similar to interview questions. The age split amongst the participants was heavily split; the majority were 18-24-year-olds, with 69.6% of the participants being of this age group, with the second biggest age group being the 24-35-year-olds with 12.5%. It shows that the age group is heavily based on younger to middle-aged people. The gender split was pretty even, with 52.7% female and 47.3% male. The annual income is also heavily biased, with 70.5% of the



participants having an annual income of 0-20,000 euros. The second biggest group was the participants, who had an annual income of 20,000-40,000 Euros, which had a percentage of 15.2%. Regarding the educational level, most participants (46.6%) had a high school diploma. The second most participants had a bachelor's degree as their highest educational level, with 36.6% stating so. This shows that some sort of bias could appear when it comes to the answers to the questions in the quantitative research, due to the majority of people either being young and having other priorities than older people, just as with the annual income being lower, showing that some bias might be seen due to these people not being able to afford some products etc. As it was mentioned in the “The Influence of Social Media on Consumer Behaviour” part, consumers can be influenced through advertisements, with more personalized advertisements targeted to specific groups of people (Zhu & Chang, 2016, p.442). As stated by Alalwan (2018), when the feeling of relating to a social media ad is perceived, the product is more likely to be purchased by the consumer (p.73). This is important due to different answers being given for the first qualitative question (Question 12), “Have you made a purchase directly influenced by social media? If yes, please provide details.” that described the consumer being influenced into buying certain products like clothes or other fashion items by targeted and personalized ads:

- 1) "Personalized advertisements on Instagram led to purchasing a product, e.g. I was looking for gloves, and I got special ones through a shop via Instagram."
- 2) “The 304 Clothing brand was shown to me through Instagram ads. I made a purchase and was satisfied.”
- 3) “Once ordered 3 pairs of shades off of an instagram ad.”

This simply shows that there have already been instances among the participants where some of them were influenced by an advertisement on Instagram to purchase a product. Others have simply answered that they indeed have been influenced by various ways of advertisements:

- 1) "Yes, I have multiple times. Usually, i am influenced by Instagram Story Ads”
- 2) "Yes, I got an advertisement on Instagram and purchased the item”
- 3) “yes, through Instagram advertisements”
- 4) “Christmas presents after an ad”
- 5) "Yes, after an IG Story, I clicked on the link and bought the product."
- 6) “Sportswear advertised via paid ad”

This shows that, indeed, through methods such as advertisements, especially personalized advertisements, consumers can be influenced into buying a certain product. It directly confirms that, indeed, through social media advertisements, a consumer's behaviour and decision-making process can be altered to buy a product. As stated by Bogнар et al. (2019), celebrities are used by companies to increase awareness or perception of the brand due to these celebrities being trusted by consumers (p.304). The same goes with influencers nowadays being used by various organizations to spread particular messages or trends that could lead to new customers being attracted, new communities being created, brand awareness being raised, and also, ultimately, different products being marketed by them (Bognar et al., 2019, p.305). It has also been shown that influencer recommendations are being reacted to more significantly by consumers, and therefore, they are being influenced by them to purchase a product, and their decision-making process is being influenced and altered (Bognar et al., 2019, p.308). In the same, various answers were given that some participants indeed have been influenced through influencers or celebrities to purchase a product:

- 1) "I have bought merch from influencers before."
- 2) "Once a couple of YouTubers released merch, and since I am a huge fan of them, I decided to buy it. They marketed it heavily across their social media channels, from YouTube to

Instagram to Twitter. They made multiple posts about their collection, which regularly brought attention to me, so I did not miss the drop."

- 3) "recommendations from influencers"
- 4) "I bought some clothes which were advertised by influencers."
- 5) "Good Coupons from Influencing people"
- 6) "Buying a book because of the social media presence of an author"
- 7) "Usually clothes that I see on influencers"
- 8) "If there are influencers I have followed for a long time that recommend a good product, I will likely buy it. Also, if a product comes often on my FYP and it seems relevant to me I am highly influenced to buy it (especially if it is related to makeup & skincare)"

This shows directly some instances of participants of the survey being influenced by celebrities or influencers into buying any product, also confirming the found outcomes of the literature review that influencers or celebrities can indeed influence consumers into buying products, and therefore, their consumer behaviour and decision-making process being altered or influenced by them. Directly related to this open question, due to Figure 1, in which the likeliness of the participants to purchase after seeing an advertisement or sponsored content on social media is described, it can be seen that, indeed, participants can be convinced through these to make a purchase. Only 19.8% of the participants answered that they are not likely at all to be influenced to make a purchase after seeing such content. The other 80.2% are likely to make a purchase after seeing such content. The tendency here is still more towards not being likely to make a purchase after seeing such content due to the arithmetic mean calculated being 2.351351. This simply shows that, indeed, consumers can be influenced to make a purchase after seeing such content, confirming the results of the literature review. Yet, it still might not be as effective as the companies would like it to be.

How likely are you to make a purchase after seeing an advertisement or sponsored content on social media?  
111 Antworten

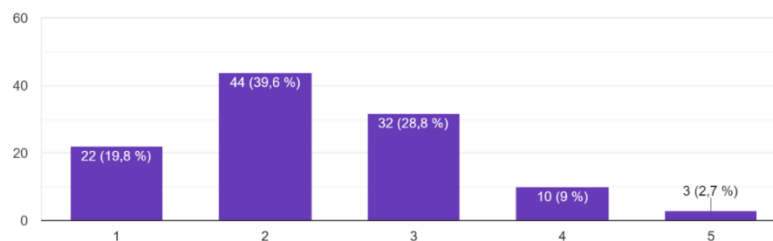

*Figure 1: Likeliness of Product Purchase after Advertisement or Sponsored Content*  
*Source: Own illustration*

How far influencers or celebrities can influence the participants to make a purchase was shown in Figure 2, where 27% of the answers were that they are not likely at all to make a purchase after seeing such content. This shows that the majority (73%) are still likely to make a purchase after seeing such content. But, as with the participant's tendency to be influenced by advertisements being more towards not likely to be influenced, the tendency of being influenced by influencers and celebrities also tends more towards not likely to be influenced, with the arithmetic mean here being 2.396394. Again, this shows that these celebrities and influencers can influence consumers, confirming the results of the literature review. Still, this way of marketing might be less effective.

Do you feel influenced by influencers or celebrities on social media when making purchase decisions?  
111 Antworten

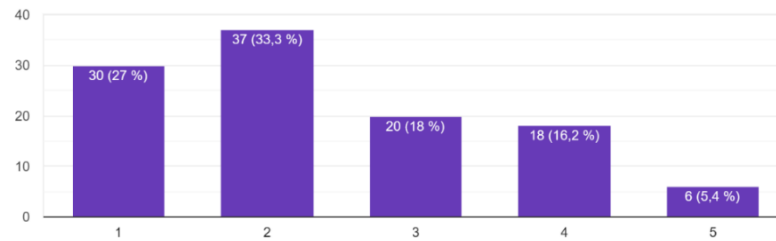
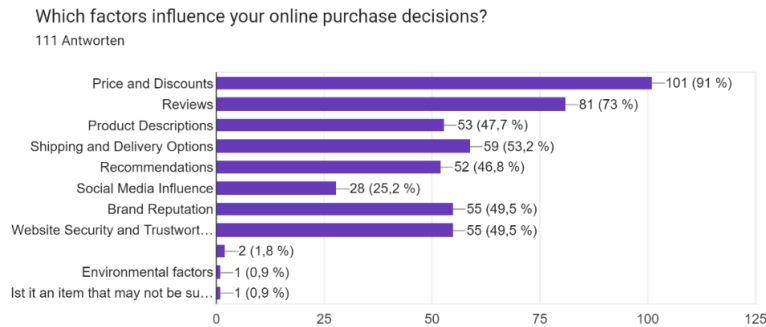

*Figure 2: Influence of Influencers and Celebrities with Purchase Decisions*

*Source: Own illustration*

The participants are more likely to be influenced by influencers or celebrities to purchase than by advertisements or sponsored content due to the slightly higher arithmetic mean here:  $2.396394 > 2.351351$ . This could have further implications for how organizations or companies could market their products more efficiently through social media to get more interactions between consumers and their products, which could lead to a possible product purchase. As taken from the previous literature review, consumers' decision-making process and behaviour being influenced by Word-of-Mouth has been shown. Humphreys (2017) states that social influence in consumer behaviour has been conceived as word-of-mouth communication. An essential part of consumer behaviour is played by this social influence (Humphreys, 2017, p. 371). Huete-Alcoer (2017) has elaborated that marketing information being exchanged between consumers in a way that changes their attitudes towards the products or services they are communicating about is a big part of online communication (p.1). Things such as reviews, ratings, ratings of ratings, comments, and more can be considered as this type of communication (Humphreys, 2017, p.371). This results in different aspects of consumer behaviour being heavily influenced by word-of-mouth on social media (Humphreys, 2017, p.372). Therefore, word-of-mouth is being trusted more than the companies' mass media messages and advertising because consumers perceive these reviews to be more like themselves (Humphreys, 2017, p.372). Even as has been stated by other authors, such as Voramontri & Klieb (2019), consumers are being influenced by online consumer reviews, and it has been shown that these are causing a causal impact on purchase behaviour and product choice (p.216). As mentioned in the literature review, the importance of this aspect with reviews and online word-of-mouth has been highlighted by many more authors, yet with the quantitative research, it can also be confirmed that reviews play an important role when it comes to consumers being influenced by it. As shown in Figure 3, one of the aspects that are being paid attention to by the participants, as to what influences their decision-making when making a purchase, is reviews.

*Figure following on the next page*



*Figure 3: Factors influence online purchase decisions*  
*Source: Own illustration*

The second most voted answer among the participants was reviews, with them being paid attention to by 73%, showing that reviews influence most people. As also shown in Figure 4, whether opinions or recommendations are being searched upon on social media by the participants when making a purchase decision has shown the selection “Never” has been chosen by only 11.6% of the participants, showing that these are looked up at least rarely before finalizing a purchase by 88.4% of the participants. With the answers of “Often” being picked by 25% and “Very Often” being picked by 10.7%, a substantial group of participants looked these up on a very regular basis, with 30.4% of all participants claiming that the recommendations and opinions are being considered by them at least occasionally when making a purchase decision online, it is also shown here, that even just at least occasionally consumers can be influenced through these.

How often do you seek opinions or recommendations from your social media network before making an online purchase?  
112 Antworten

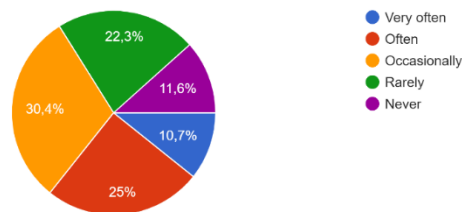

*Figure 4: Frequency of recommendations and opinions sought on social media*  
*Source: Own illustration*

Here, with it being claimed by the majority of participants (73%) that reviews are influencing their purchase behaviour and the majority of participants claiming that others' recommendations and opinions online before following through with a purchase decision are looked up by them, it can be confirmed, that people can indeed be influenced by social media, through word-of-mouth, for example, being reviews online or other opinions and recommendations, which then ultimately leads to the consumer's decision-making process and their behaviour being altered. As it was already mentioned beforehand, a vital role is played by some factors, such as occupation and economic conditions, when it comes to a consumer purchase decision (Stávková et al., 2008, p.277). As already mentioned, with the occupations and the income level of the participants, most of the answers were from students, and 70.5% of the participants had an

annual income level of 0 – 20,000 Euro, showing that it could be possible for some bias regarding the rest of the research. Therefore, it is also not a surprise that in Figure 3, it can be seen that the majority of 91% of the factors that influence the consumer's decision-making process the most are price and discounts. Correlating with this is that, indeed, social media can be used by organizations to communicate with their customers (Humphreys, 2017, p.363). This also includes communication of sale promotions and other information with their customers (Reitz, 2012, p.45). Even some of the answers to the question “Please share any specific experiences or instances where social media has significantly influenced your online shopping behaviour” have stated some sort of influence of prices and discounts on certain participants' purchasing behaviour:

- 1) "Black Friday"
- 2) "Special deals and offers on clothes, for example, when I don't necessarily need new clothes."
- 3) “Black Friday sales, 2for1 deals”
- 4) “TEMU/Aliexpress made me buy a lot of stuff I don’t need bc it’s cheap”

Yet, what needs to be noted is that most of the time, the prices were actually compared between different retailers while shopping online before finalizing a purchase. In Figure 5, it can be seen that prices are often compared by 37.5% of the participants and very often by 32.1%, showing that prices are considered by the majority of 69.9% at least often before a purchase is finalized. With the option of "Never" being chosen by only 0.9% of the participants regarding how often they compare prices, prices are being compared by 99.1% of the people who answered the survey before purchasing a good. Stankevich (2017) states that consumers can be influenced by price, quality, brand, location, and many more when searching for the best deal (Stankevich, 2017, p.11). However, due to the possibility of the competitor's websites being very easily accessible when represented in the electronic space, consumers can find alternatives with these competitors very conveniently (Jain et al., 2021, p.665). Therefore, the possibility of a customer being attracted by a price marketed on social media could give the the purchase intention, but due to the majority shown comparing prices before purchasing a product (Figure 5), the purchase of the initial product could be refrained from.

Do you compare prices or products across different online retailers before making a purchase? If yes, how often?  
112 Antworten

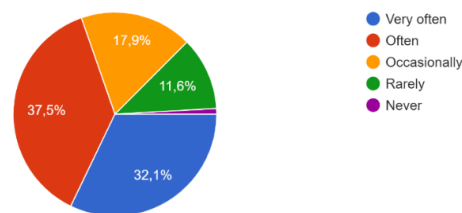

*Figure 5: Frequency of how often products and prices are compared*

*Source: Own illustration*

All of this shows that one of the factors that influences consumer decision-making and behaviour that is being paid attention to the most is prices. Social media and the communication of low prices or sale promotions, like Black Friday, can lead to the consumer being influenced by them to purchase something. Yet, due to the nature of most people comparing prices before purchase, they could refrain from initially purchasing the marketed special-priced product due

to finding a better alternative. Therefore, by comparing the existing literature analyzed in the literature review with the quantitative research conducted, the similarities and relationship between social media and consumer behaviour and the decision-making process can be seen. As seen, the participants were indeed influenced in the past by factors and ways that were described by numerous authors previously, resulting in confirming that consumers can be influenced by social media and the way it is being used by companies, influencers, celebrities, etc. After examining the study and previous literature, further implications for theory and practice can be made. The first implication that can be made is about the way how products can be marketed more efficiently. We have seen that advertising is one of the ways mentioned in literature by which the consumer decision-making process can be influenced (Zhu & Chang, 2016, p.442; Alalwan, 2018, p.73). The research showed that advertisements influenced the participants, and certain purchases were made, with targeted advertisements being received or advertisements being seen in general on social media. This simply shows that when trying to market a product, advertisements and, even better, targeted advertisements could be beneficial tools for more customers to be reached and for consumers to be persuaded by ads to buy products. Yet, as shown by the tendency of the participants in Figure 1 as to how likely they are to make a purchase after an advertisement is seen, the tendency is instead leaning towards them not being very likely to make this purchase. This simply shows that, indeed, more reach and new customers can be gained through advertisements by organizations, and advertisements can initiate the first initial impulse to purchase a product. Yet, these may not be as effective as other ways to market their products. Another way that has been shown in literature and was seen with the research is marketing with influencers or celebrities (Bognar et al., 2019, pp.304-308). Again, as with the advertisements, some participants claimed that they had been influenced directly by influencers or celebrities to purchase a certain product. This shows that consumers can definitely be influenced to purchase by influencers or celebrities. Yet also here, it was depicted in Figure 2 that their likeliness, if they were to buy a product after seeing some content being marketed by an influencer or celebrity, is tending towards not being very likely to purchase it. Also, this shows that by influencers and celebrities being used by companies to market their products, their reach can be further expanded, but this way of marketing might not be as effective as perceived. However, the important aspect of how consumers follow and interact with many brands and influencers must be noted here. As shown in Figure 6, it was stated by only 15.2% of the people who answered the survey that these "Never" interacted with them, showing that influencers and brands are being followed and interacted with by 84.8%, with even 30.3% stating that these are either often or very often followed and interacted with. This shows that, indeed, such ways as influencer marketing can reach most people or simply advertisements directly by the brands, but here, of course, not everybody will see it as often as others.

Do you follow or interact with brands or influencers on social media? If yes, how often?  
112 Antworten

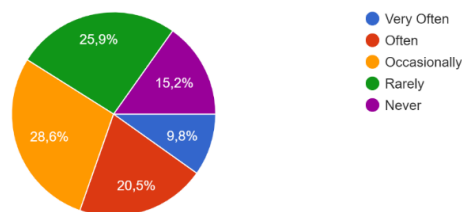

*Figure 6: Interaction with Brands and Influencers*

*Source: Own illustration*

Another important aspect here that has to be noted is that when calculating the arithmetic mean for both the likeliness of the participants to purchase a product after seeing an advertisement or after seeing sponsored content by influencers or celebrities, it can be seen that the consumers are more likely to be influenced to purchase a product after sponsored content by influencers and celebrities is seen than advertisements for products being seen due to the arithmetic mean being 2.396394 for influencers and celebrities and 2.351351 for advertisements. This shows that the tendency for the first way of marketing with influencers and celebrities is more keen to be seen by consumers than advertisements. This difference is minor, yet this could indicate how marketing could be changed in the future to gain a bigger reach more effectively. Another part that could be important for marketers is what kind of social media is being used very often by consumers to see where and also how their products should be marketed most effectively. This is depicted in Figure 7, in which case it is clearly seen that Instagram and YouTube are used the most by the participants, with Snapchat and TikTok being in third and fourth place for most used social media platforms. The common feature that is had by these together is that visual content like Images, photos, short-form videos, and long-form videos are being relied on by them (Tafesse, 2019, p.1689; Lim & Yazdanifard, 2014, p.3; Choi & Sung, 2018, p.2291; Juwariyah et al., 2021, p.258). The three most interacted with content types on social media by the participants are depicted in Figure 8. Therefore, a further implication for marketers could be for their product to be marketed on a visual basis on one of these aforementioned social media platforms, for example, with short-form videos or images on Instagram, due to the majority of consumers using these social media platforms and interacting with this type of content the most.

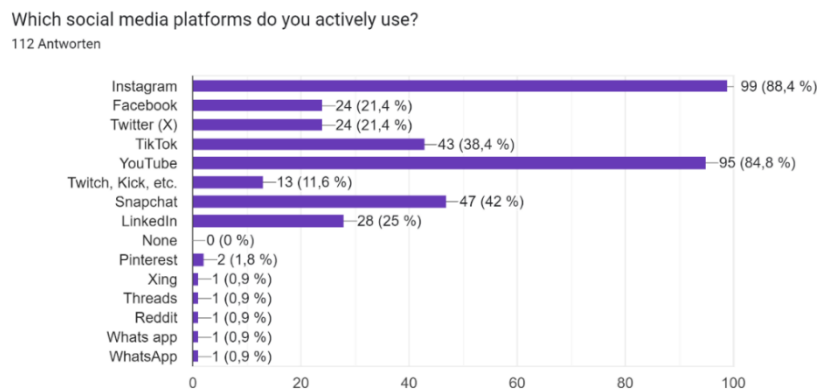

Figure 7: Social Media Platforms Split Used by Participants  
Source: Own illustration

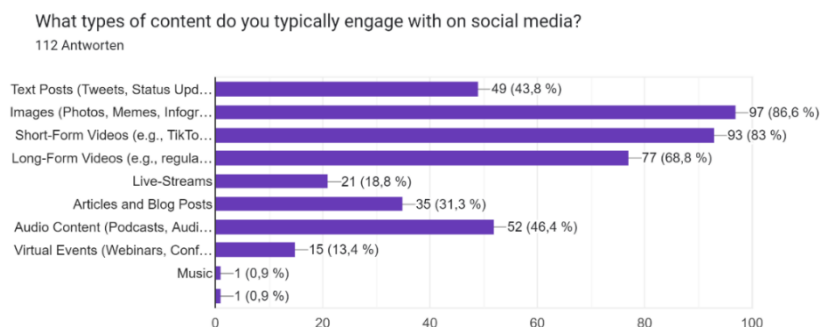

Figure 8: Content Engagement of the Participants  
Source: Own illustration

Another part that might be needed to focus on is the last and fifth stage of the traditional decision-making model, which is the post-purchase stage, in which the consumers make evaluations and reviews about the product (Stankevich, 2017, p.11). As has already been stated in the literature review, not only can consumer behaviour be influenced by word-of-mouth, but companies' sales or stock prices can also be affected by it (Humphreys, 2017, p.372). It has also been shown that more influence is had by word-of-mouth than mass media messages and that reviews are trusted more than advertising of companies by customers (Humphreys, 2017, p.372). With also reviews being the second most influential factor when it came to the survey participants' online purchase behaviour, with 73% of them stating that they are being influenced by reviews (Figure 3), it shows that it is important for a brand to give the consumers a positive shopping experience, with a satisfying product to gain then positive reviews, which in conclusion could lead to more customers and sales. For this to be achieved, transparency and honesty would be an important factor to be practised by the companies selling the product, due to also the main factors that participants of the survey gave that need to be improved in the commerce world being these two (Question 24 and Question 25). As also seen by the answers given in Question 24, some of the main aspects perceived as negative by the survey participants were the possibility of getting scammed, dishonesty, mistrust, lack of transparency, etc., in online commerce. All of this shows that when a product is being sold online, transparency and honesty need to be practised so positive reviews will be received. In other words, positive online word-of-mouth could be spread, through which the company's sales could be positively influenced. As shown in Figure 3, for 49.5%, trustworthiness and website security are important factors in whether to purchase a product. As stated by Stankevich (2017), in this post-purchase stage, it needs to be analyzed whether the person was satisfied or not for them to be turned into loyal customers (p.11). Therefore, multiple implications for theory and further practice can be done with the basis of the literature and the quantitative research conducted, ranging from different ways of advertisement up to post-purchase behaviour and the need to be transparent and honest to increase the chances of positive reviews and positive word-of-mouth.

## **6. CONCLUSION**

The main aim of this research was to find out how and to what extent consumers are being influenced by social media, its influencers, and the organizations using it to their advantage so that the consumer's decision-making process and behaviour can be altered. The literature review and quantitative research show that consumers can be influenced in various ways, altering their decision-making process and purchasing behaviour. Through different ways, such as online word-of-mouth like reviews, recommendations, etc., consumers can be influenced to buy certain products by other consumers, as the source is perceived to be more like themselves (Humphreys, 2017, p.372). Other ways, such as advertisements, are being used by companies to convince consumers to purchase their products, with the ability by these organizations to advertise very specifically and personalized to individuals (Zhu & Chang, 2016, p.442). With then different advertisements, such as ads related to their preferences and interests and interactive ads, the customers are more likely to be influenced by them to purchase a product (Alalwan, 2018, pp.72-73). Companies can use celebrity and influencer marketing to market their products in another way, very often used in a way where the companies use influencers to spread a certain message or trend online to their followers and the target audience as sponsored content (Bognar et al., 2019, pp.304-305). Here, influencers are used to raise brand awareness and create a loyal customer base for certain brands (Bognar et al., 2019, p.305). Therefore, a connection can be made easier with the consumers due to the influencers being trusted by these, making them more willing to purchase a product that might be advertised in such a way (Bognar et al., 2019, p.305). Even different factors, such as prices, occupation, family, age, etc., have been found to be crucial factors in altering consumers' purchase behaviour (Stankevich, 2017,



p.11; Stávková et al., 2008, pp.276-277; GAJJAR, 2013, pp.11-12; Ramya & Ali, 2016, pp.77-80). All of these aspects have been confirmed as accurate by the research. The participants could have been and, in some instances, were indeed influenced by these aspects, such as price, other reviews of other people, advertisements, and influencers (see 3.1 Quantitative Research – Findings and 4. Discussion). The factors that the participants paid attention to the most were prices and discounts, with reviews being in second place after them (Figure 3). With also other qualitative questions (Questions 12 & 23) asked in the survey and the likeliness asked of how likely the participants were to make a purchase after seeing either advertisements (Figure 1) or sponsored content by influencers or brands (Figure 2), it was shown, that indeed the majority of participants are somewhat likely to be influenced by these factors and aspects of social media, for their decision-making process to be influenced and their consumer behaviour to be altered. As it has been already described, there are some limitations to this study and this research. Starting with the research limitations, the first is biased regarding the participants. Due to the researcher being known by the participants, participants could behave biased when answering the survey, showing participant bias (Saunders et al., 2016, p.203). As explained earlier, a possible refrain from truthful answers could have been made due to the possible fear of being judged (Saunders et al., 2016, p.203). Possible participant errors could have occurred, for example, by not completely understanding the questions due to them being in English and the majority of the participants being Germany-based or from other countries where English is not the native language (Saunders et al., 2016, p.203). Also, simple errors such as misclicks could have happened. The possibility that certain decisions were made by participants earlier in the survey, which they then came to realize was wrong later on but simply did not change the previous ones, could have also been made. The research could also have gone much more into detail with questions about how strongly different advertised products when displayed in a more visually appealing way, influence the purchase decision. Still, it would be possible to go further into different aspects with more detailed research for specific topics. A possibility would be for a study to be conducted on how consumer behaviour and the decision-making process are being influenced by different ways of online advertising on social media by different companies with different backgrounds, what kinds of advertisements are being used on different social media platforms, and how effective these are. Another future research direction could be how consumer behaviour and the decision-making process are influenced by particular influencer and celebrity marketing techniques very specifically, for it to be seen how different companies from different backgrounds use these influencers and how successful this is, just like with regular advertising techniques. Further research could also contain more focus on specific aspects like consumer behaviour and the decision-making process between groups like teenagers, young adults, families, single people, older people, etc., due to a lot of different factors having different influences on people, like their occupation, culture, age, family, lifestyle, etc. (Stávková et al., 2008, p.277). Another direction could also be to analyze further how consumers are influenced by reviews, by the number of reviews, the quality of reviews, and online word-of-mouth in general with recommendations, etc., as authors have stated that these and many more factors can play into the influence of a purchase decision (Humphreys, 2017, p.372; Zhang et al., 2014, p.85). Possible implications as to how advertisements, influencer marketing, and the care of post-purchase behaviour for consumers can be used to improve a company's marketing standpoint and how effective it may seem to implement these have been given. From targeted ads to influencer marketing and the improvement of the purchase experience, for positive post-purchase WOM, etc., it has been discussed in part "Discussion – Interpretation and Implications" whether these seem adequate compared to the research outcomes. Also, possible recommendations as to what social media platforms, like Instagram and YouTube, and what kind of content to use, like images, short-form and long-form videos, due to these being selected as the most used and interacted with, by the participants

in the survey, have also been given. With the earlier-mentioned significance of social media and e-commerce, this thesis and the outcomes of the literature review and quantitative research have given a comprehensive current insight into this topic. The fact that social media is prevalent nowadays and is becoming a very important topic for businesses and executives (Pourkhani et al., 2019, p.223) shows the importance of research in this area. With e-commerce also having 3.094 Billion users in its market (Statista, 2023, p.3) and social media being used by as many as 4.76 Billion users (Statista, 2023, p.4) just by the immense extent and reach these two areas have it is shown how important further research here is.

#### LITERATURE:

1. Alalwan, A. A. (2018). *Investigating the impact of social media advertising features on customer purchase intention*. Location: International Journal of Information Management, 42, 65–77. Retrieved 07.02.2024 from <https://doi.org/10.1016/j.ijinfomgt.2018.06.001>
2. Ashman, R., Solomon, M. R., & Wolny, J. (2015). *An old model for a new age: Consumer decision making in participatory digital culture*. Location: Journal of Customer Behaviour, 14(2), 127–146. Retrieved 06.02.2024 from <https://doi.org/10.1362/147539215x14373846805743>
3. Bognar, Z. B., Puljić, N. P., & Kadežabek, D. (2019). *Impact of influencer marketing on consumer behaviour*. Location: ResearchGate; unknown. Retrieved 07.02.2024 from [https://www.researchgate.net/publication/368880285\\_Impact\\_of\\_influencer\\_marketing\\_on\\_consumer\\_behaviour](https://www.researchgate.net/publication/368880285_Impact_of_influencer_marketing_on_consumer_behaviour)
4. Buttle, F. A. (1998). *Word of mouth: Understanding and managing referral marketing*. Location: ResearchGate; Taylor & Francis. Retrieved 30.10.2024 from [https://www.researchgate.net/publication/247518391\\_Word\\_of\\_mouth\\_Understanding\\_and\\_managing\\_referral\\_marketing](https://www.researchgate.net/publication/247518391_Word_of_mouth_Understanding_and_managing_referral_marketing)
5. Choi, T.R. & Sung, Y. (2018). *Instagram versus Snapchat: Self-expression and privacy concern on social media*. Location: Telematics and Informatics, 35(8), 2289–2298. Retrieved 13.03.2024 from <https://doi.org/10.1016/j.tele.2018.09.009>
6. GAJJAR, N. B. (2013). *Factors Affecting Consumer Behavior*. Location: International Journal of Research in Humanities and Social Sciences (Vol. 1, Issue 2, pp. 10–15). Retrieved 31.01.2024 from [https://www.rajmr.com/ijrhs/wp-content/uploads/2017/11/IJRHS\\_2013\\_vol01\\_issue\\_02\\_02.pdf](https://www.rajmr.com/ijrhs/wp-content/uploads/2017/11/IJRHS_2013_vol01_issue_02_02.pdf)
7. Huete-Alcocer, N. (2017). *A Literature Review of Word of Mouth and Electronic Word of Mouth: Implications for Consumer Behavior*. Location: Frontiers in Psychology, 8. Retrieved 30.01.2024 from <https://doi.org/10.3389/fpsyg.2017.01256>
8. Humphreys, A. (2017). *Social Media*. Location: Routledge eBooks, 363–379. Retrieved 26.01.2024 from <https://doi.org/10.4324/9781315526935-23>
9. Jain, V., Malviya, B. & Arya, S. (2021, May 22). *An Overview of Electronic Commerce (e-Commerce)*. Location: ResearchGate; Swinburne University of Technology. Retrieved 23.01.2024 from [https://www.researchgate.net/publication/351775073\\_An\\_Overview\\_of\\_Electronic\\_Commerce\\_e-Commerce](https://www.researchgate.net/publication/351775073_An_Overview_of_Electronic_Commerce_e-Commerce)
10. Jamil, K., Dunnan, L., Gul, R.F., Shehzad, M.U., Gillani, S.H.M., & Awan, F.H. (2022). *Role of Social Media Marketing Activities in Influencing Customer Intentions: A Perspective of a New Emerging Era*. Location: Frontiers in Psychology, 12. Retrieved 15.01.2024 from <https://doi.org/10.3389/fpsyg.2021.808525>
11. Juwariyah, A., Noodiana, N., & Wahyuning, E. (2021). *TikTok Function in the Millennial Era*. Location: Advances in Social Science, Education and Humanities Research. Retrieved 08.03.2024 from <https://doi.org/10.2991/assehr.k.211223.045>

12. Lim, S. H., & Yazdanifard, R. (2014, September 6). *How Instagram can be used as a tool in social networking marketing*. Location: ResearchGate; unknown. Retrieved 08.03.2024 from [https://www.researchgate.net/publication/265377226\\_How\\_Instagram\\_can\\_be\\_used\\_as\\_a\\_tool\\_in\\_social\\_networking\\_marketing](https://www.researchgate.net/publication/265377226_How_Instagram_can_be_used_as_a_tool_in_social_networking_marketing)
13. Pourkhani, A., Abdipour, K., Baher, B., & Moslehpour, M. (2019). *The impact of social media in business growth and performance: A scientometrics analysis*. Location: International Journal of Data and Network Science, 3(3), 223–244. Retrieved 18.01.2024 from <https://m.growingscience.com/beta/ijds/3089-the-impact-of-social-media-in-business-growth-and-performance-a-scientometrics-analysis.html>
14. Ramya, N., & Ali, M. (2016, September 13). *Factors affecting consumer buying behaviour*. Location: ResearchGate; unknown. Retrieved 05.02.2024 from [https://www.researchgate.net/publication/316429866\\_Factors\\_affecting\\_consumer\\_buying\\_behavior](https://www.researchgate.net/publication/316429866_Factors_affecting_consumer_buying_behavior)
15. Reitz, A. (2012). *Social Media's Function in Organizations: A Functional Analysis Approach*. Retrieved 04.02.2024 from [http://gmj-canadianedition.ca/wp-content/uploads/2018/11/v5i2\\_reitz.pdf](http://gmj-canadianedition.ca/wp-content/uploads/2018/11/v5i2_reitz.pdf)
16. Riaz, M. U., Guang, L. X., Zafar, M., Shahzad, F., Shahbaz, M., & Lateef, M. (2021). *Consumers' purchase intention and decision-making process through social networking sites: a social commerce construct*. Location: Hsrw. eu. Retrieved 07.02.2024 from <https://web-p-ebsohost-com.ezproxy2.hsrw.eu/ehost/pdfviewer/pdfviewer?vid=0&sid=b329d036-dd13-4726-af37-04d25dd06f89%40redis>
17. Rosário, A. T., & Dias, J. C. (2023). *Marketing Strategies on Social Media Platforms*. Location: International Journal of E-Business Research, 19(1), 1–25. Retrieved 15.01.2024 from <https://doi.org/10.4018/ijebr.316969>
18. Saunders, M., Lewis, P., & Thornhill, A. (2016). *Research Methods for Business Students (7th ed.)*. Location: Pearson Education Limited. Retrieved 14.02.2024 from <https://ebookcentral.proquest.com/lib/hrw/reader.action?docID=5832826>
19. Stankevich, A. (2017). *Explaining the Consumer Decision-Making Process: Critical Literature Review*. Location: Journal of International Business Research and Marketing, 2(6), 7–14. Retrieved 31.01.2024 from <https://ideas.repec.org/a/mgs/jibrme/v2y2017i6p7-14.html>
20. Statista. (2023). *Social Commerce* | Location: Statista. Retrieved 06.02.2024 from <https://de-statista-com.ezproxy2.hsrw.eu/statistik/studie/id/111842/dokument/social-commerce/>
21. Stávková, J., Stejskal, L., & Toufarová, Z. (2008). *Factors Influencing Consumer Behaviour*. Location: Agricultural Economics (Zemědělská Ekonomika), 54(No. 6), 276–284. Retrieved 30.01.2024 from <https://doi.org/10.17221/283-agricecon>
22. Tafesse, W. (2019). *YouTube marketing: how marketers' video optimization practices influence video views*. Location: Emerald Insight. Internet Research, 30(6), 1689–1707. Retrieved 08.03.2024 from <https://doi.org/10.1108/INTR>
23. Voramontri, D., & Klieb, L. (2019). *Impact of social media on consumer behaviour*. Location: International Journal of Information and Decision Sciences, 11(3), 209–209. Retrieved 06.02.2024 from <https://doi.org/10.1504/ijids.2019.101994>
24. Zhang, K. Z. K., Zhao, S. J., Cheung, C. M. K., & Lee, M. K. O. (2014). *Examining the influence of online reviews on consumers' decision-making: A heuristic–systematic model*. Location: Decision Support Systems, 67, 78–89. Retrieved 06.02.2024 from <https://doi.org/10.1016/j.dss.2014.08.005>
25. Zhu, Y.-Q., & Chang, J.-H. (2016). *The key role of relevance in personalized advertisement: Examining its impact on perceptions of privacy invasion, self-awareness, and continuous use intentions*. Location: Computers in Human Behavior, 65, 442–447. Retrieved 07.02.2024 from <https://doi.org/10.1016/j.chb.2016.08.048>

# THE IMPORTANCE OF THE ZERO MOMENT OF TRUTH IN THE "Z" GENERATION

**Monika Rezic**

*Student at Virovitica University of Applied Sciences, Croatia  
monika.rezic2@gmail.com*

**Zrinka Blazevic Bognar**

*Virovitica University of Applied Sciences, Croatia  
zrinka.blazevic@vuv.hr*

**Ema Sesvecan**

*Virovitica University of Applied Sciences, Croatia  
ema.sesvecan@vuv.hr*

## **ABSTRACT**

*In today's dynamic market environment, the idea that consumers know themselves and their needs best is a fundamental principle that reflects the importance of understanding consumers' inner motives and desires. Consumers typically have a deep understanding of their needs, preferences, and life goals, and are motivated to act to satisfy those needs. Given this premise, the company's role is not only in providing products and services but also in directing and encouraging these consumer motives. The zero moment of truth (ZMOT) represents a crucial moment in the buying process, where consumers research products or services online before making a final purchase decision. ZMOT marks a change in the behavior of consumers, who increasingly use digital channels to research products and services, highlighting the importance of a brand's digital presence. In addition, ZMOT provides an opportunity for brands to influence consumers at a time when they are open to information and influence. By properly managing ZMOT, brands can increase their presence, improve conversion, and build consumer loyalty. Therefore, understanding and effectively managing ZMOT is crucial for the success of brands in today's digital environment and competitive market. The goal of this research is to determine the differences in the behavior of consumers X, Y, Z, generation in the virtual environment, i.e. online stores, as well as whose experiences consumers value more when deciding to purchase a product or service. Let's consider electronic word-of-mouth communication (eWOM) in the Z generation with the mentioned terms and research. We will get significant results on how much consumer behavior changes depending on which generation it belongs to.*

**Keywords:** *consumer behavior, Z generation, zero moment of truth*

## **1. INTRODUCTION**

Companies, nowadays, have to implement new marketing strategies in order to understand the needs of customers and their purchase behavior. These strategies include various activities such as providing consumers relevant information about products and services, creating brands that reflect consumers' values and identity, and ensuring a positive shopping experience. With understanding consumers preferences and adapting products and services to their expectations, companies can ensure customer loyalty and long-term success in the market. Companies have also take in consideration numerous external factors such as marketing messages, social norms or group pressure which can have a major influence on consumer behavior. These factors can shape consumer perceptions and decisions, often on an unconscious level. Therefore, the companies have to be focused on understanding and responding to the real needs and desires of consumers what is crucial for success in the market.

## **2. CONSUMER BEHAVIOR**

Digital era and numerous technological solutions have resulted with various communication models which give a new communication dimension to a society (Kraljević, Gujić and Milun, 2014). Considering the prevalence and mass use of the Internet, companies have realized importance of communication via the Internet. Back in 1967, Johan Arndt defined word-of-mouth communication as a personal, non-commercial exchange of information about products and services between acquaintances. In his paper, he also researched the potentially harmful effects of negative communication (Arndt, 1967, p. 292). More recent theories, such as that of Litvin et al. (Litvin, Goldsmith and Pan, 2008, p. 460), describe word-of-mouth as informal communication between consumers about products or services that can be positive or negative. Based on Arndt's works, Harrison-Walker (Harrison-Walker, 2001, p. 62) defines this communication as an informal personal exchange of information between a non-commercial sender and a receiver, related to a specific product, service, brand or organization. Numerous research suggests that word-of-mouth communication often has a stronger impact on consumers in comparison to traditional marketing strategies (Tseng, Kuo and Chen, 2014; Goldenberge, Libai and Muller, 2001). In 2006, 82% of the fastest growing companies used this type of communication. (Ferguson, 2008). The significance of its influence has been pointed out by many authors (Arndt, 1967; King and Summer, 1970; Herr, Kardes and Kim, 1991), however, with the advent of the Internet, its possibilities and influence have grown significantly. Hennig-Thurau et al. (2004) provide a more specific definition of electronic word-of-mouth communication. According to them, eWOM is defined as "positive or negative statement made by potential, actual, or former customers about a product or company, which is made available to a multitude of people and institutions via the Internet". (Hennig-Thurau et al., 2004, p. 39). This definition highlights that eWOM can involve different consumer perspectives and how it can significantly affect the reputation of a product or company. Electronic word-of-mouth enables faster and wider dissemination of information and provides greater transparency, significantly influencing consumer decisions. Advanced technology and development of the Internet resulted with new forms of social media, including social networks, blogs, microblogs, forums, review sites, and multimedia content sharing platforms. Marketers emphasize the importance of social networks and social media, which are often equated, due to their frequent use. This division provides a better understanding of how information is shared and how they influence on consumers through different digital channels (Cheung and Thadani, 2010; Tseng, Kuo and Chen, 2014). Weisfeld-Spolter, Sussan and Gould (2014) propose a categorization of electronic word-of-mouth communication based on the form of communication and the level of interaction. According to their division, this type of communication can be classified into four categories: many-to-one, many-to-many, one-to-many and one-to-one. Each category describes how information is disseminated between participants, given the number of participants in the communication and the mode of interaction.

## **3. GENERATIONS X, Y, Z**

Many factors influence consumer behavior while one of important factors is age of consumers. Technological disruptors such as the Internet have enabled consumers to shape their thoughts and behavior through global electronic word-of-mouth communication. Understanding different generations is becoming increasingly important in today's society, especially in the context of business, education and social relationships. Generations X, Y and Z represent three different groups of people and each of these generations has unique characteristics, values and preferences. Generation X, born between 1965 and 1980, grew up in a period of significant social and technological change. This generation is known for its flexibility, desire for personal development and tendency towards collectivism.

Generation Z is the first generation which grow up with smartphones and constant internet access, and is highly connected to the digital world, which shapes their communication habits, educational needs and consumer preferences. According to the Shopper's Mind Slovenia survey from 2016, conducted in collaboration with Ceneje and research agency Valicon, in which 5,352 internet users participated, generations X, Y and Z differ significantly in their shopping habits. Generation X prefers physical stores, while Y and Z prefer online shopping. Generation Z mostly uses mobile devices for online shopping, Y generation appreciates the convenience of online shopping due to better delivery and a larger selection of products. Baby boomers use the Internet to explore information before purchasing, but they shop online less often (Smind.si, 2017). An interesting dynamic in purchasing behavior exists in the use of different technologies. The biggest differences are observed between the younger generations and the population over 55, which is slower to adopt mobile technologies for research and shopping. Generation Z uses mobile devices extensively for research, while 55% of respondents are searching offers via mobile devices or a combination of desktop and mobile. Minor differences between generations are observed in the purchase itself, where the computer is the main device for concluding the purchase in about 80% of cases. Shopping on mobile devices is most pronounced among generation Z, with a share of 20%.

#### **4. ZERO MOMENT OF TRUTH (ZMOT)**

Shopper marketing is a multidisciplinary field that includes a variety of tools and techniques aimed at understanding the habits, motivations and decisions of consumers in the shopping process. This approach allows marketers to observe consumer behavior from the buyer's perspective in different contexts and situations, with the aim of developing strategies that will benefit all stakeholders – from retail chains and manufacturers to consumers themselves. Different cultures also have influence on shopping habits, which further confirms that the shopping process is not simple, but complexed and fast process where customer decides to buy or abandon process of purchase. This process is often called the "customer journey" and is a key element in modern marketing strategies. Marketers therefore develop in-depth methods to identify all the key moments in the chain that leads from the initial awareness of the product or service to the actual purchase and the formation of the impression that influences the return of the customer. In the context of the digital era, special emphasis is placed on the Zero Moment of Truth (ZMOT), which arose from the development of the Internet, online shopping and online catalog. "The ZMOT represents the moment when consumers engage with a product or service online before making any commitments" (Subashini, 2024, p. 6). Between the traditional first moment of truth - when the consumer physically sees the product in the store - and the second moment of truth - when the customer forms an opinion about the product after use - there is a zero moment of truth, crucial for the digital consumer experience. The ZMOT concept, introduced by Google in 2011, was created in response to radical changes in consumer behavior caused by mas use of the Internet and globalization (Ertemel and Koksal, 2017). Before the model ZMOT, the traditional marketing model encompassed three key moments: stimulation, shelf (i.e. the moment when the consumer sees the product in the store) and experience (Lecinski, 2011). However, with the development of technology and the growth of electronic commerce, this model has become obsolete. Google has identified new customer behavior patterns, with ZMOT becoming a key moment where a consumer researches products, compares them, reads reviews and gathers information online before making a final purchase decision. "In 2018, Google noted that when a consumer decides to purchase or try a product or service is usually when they get hold of a device, such as a laptop or mobile phone. They can then start to explore as much as possible about the service or product they are looking for. There are also two types of zero moments of truth: the first occurs when a stimulus is used through the senses, and the second occurs when a search engine results" (Mahfooz, 2024, p. 35).

“The Zero Moment of Truth (ZMOT) has become a pivotal concept in understanding consumer behavior in the digital age. This section provides an in-depth discussion on the impact of the Internet and digital media, the changes in consumer information search behavior, and the role of social media, reviews, and online content in shaping the ZMOT” (Subashini, 2024, p. 5-6). ZMOT emphasizes the importance of the digital experience and the influence of the Internet on purchasing decisions. While the first moment of truth was crucial for the physical store environment, ZMOT has become crucial in the digital environment, highlighting the importance of online presence and its impact on consumer behavior. Nowadays, almost every consumer has access to the Internet, and the digital experience has become an indispensable part of the purchase decision-making process. ZMOT brings together a wide range of information that consumers are able to gather through online product research. This information includes reading reviews, product ratings and rankings, promotional videos, and other digital content. Nowadays, exist wide range of possibilities to collect information, so also there is higher probability that a potential customer will become an actual customer, based on information found on the Internet. Likelihood that consumer will make a purchase increases in proportion to the quality of the digital impression of the product what is the reason why successful brands invest great efforts in creating a positive online presence in order to achieve greater market success. The ZMOT concept has evolved over time, adapting to changes in the digital environment. The traditional shopping process followed a certain order: stimulation through advertisements, going to the store and physically interacting with the product (the first moment of truth), and the final experience of using the product (the second moment of truth). Today that process has changed significantly, consumers average use ten different sources of information before making a purchase, so brands have to monitor and adapt to these changes in order to remain competitive (Branddumine, 2012). Digital transformation has changed the way consumers make purchasing decisions, and this is particularly evident through the concept of the "Zero Moment of Truth" (ZMOT). This moment, when consumers research products online before making a purchase decision, has become a key point in the shopping journey. At this stage, consumers are not just passive recipients of information; they actively search for relevant information, comparisons, reviews and opinions of other users. The purchase decision is often based on information which consumers discover during this research, so brands need to ensure that their online presence is clear, informative and customer centric. The integration of information through various digital channels, from search browser, social networks to optimized websites - creates a comprehensive digital insight into the information and enables the consumer to make a well-informed decision. Technological innovations give the opportunity to personalize the user experience, brands that succeed in providing this personalization have a greater chance of converting users into loyal customers. With the increasing influence of mobile devices, brands must also adapt their digital strategies to enable a seamless experience across all platforms. Mobile optimization is nowadays a necessity, given that more and more consumers are using smartphones to research and shop. Ultimately, the success or failure of a brand largely depends on its ability to be visible and available at critical moments when the consumer is looking for information - because ZMOT is not just a moment of decision, but a moment in which the brand must gain trust and confirm its relevance on the market. The rate of "online cart" abandonment represents a significant challenge in e-commerce, since as many as 70% of consumers give up on completing a purchase (Statista, 2024). The reasons for this phenomenon can be different; some consumers choose not to buy the product to save money, while others prefer to do more research on the product before making a final decision. According to research, one of the most common reasons for cart abandonment is the need for a deeper understanding of the product's characteristics (Baymard, 2024). This very moment is crucial for all manufacturers, because once the customer abandons the purchase and starts researching again, it means that the manufacturer has to win him over

again. Since the manufacturer cannot prevent the consumer from abandoning the purchase, what he can do is to bring him back on the right path, i.e. the purchase path. Manufacturers are then faced with the challenge of how to bring the consumer back into the purchase process, with an emphasis on creating additional incentives and providing relevant information, and this will succeed using the so-called "affiliate publisher". An affiliate publisher is a third part of ZMOT that allows customers to come back and complete their purchase. "The participants of this form of marketing are the advertisers and publishers the affiliate network unites and the customer, who is the object of desire. Advertisers are companies that provide web-based services or products and promote those. So, advertisers must find ways to bring potential customers to their website and motivate them to purchase" (Matheja, 2014, p. 1). Ultimately, it refers to websites that allow a manufacturer to connect with customers of their products, either those who are researching a product for the first time or those who have abandoned a purchase and come back to research. It is important to note that "affiliate publisher" is not threat to producers what is important to note because manufacturers often declare them as one because they consider them to be interfering in their business and acting as middlemen (Brown, 1965). They are intermediaries in a way, but they are nevertheless intermediaries who will connect producers with consumers, i.e. who will enable consumers to see a product of a certain brand. Therefore, manufacturers should not declare them as a threat. ZMOT thus becomes a key factor that shapes market strategies and consumer behavior in the digital era (Reibstein et al., 2019).

## 5. RESEARCH

A literature review indicates a strong influence of WOM, especially eWOM, on consumer behavior and can lead to certain changes in consumer behavior. Therefore, this paper aims to analyze the impact of digital information on consumer behavior, and whether there is a difference in consumer behavior between different generations depending on individual marketing tools. Considering the goal of the research, the following hypotheses are set:

- Hypothesis 1. Marketing tools affect differently on different generations
- Hypothesis 2. ZMOT has a significant influence on the purchase decision of generation Z

Empirical research was conducted on a sample of 212 respondents based on the results of the primary survey. The survey was conducted online in the period from July 23 to 31, 2024. The main research tool was a questionnaire consisting of closed multiple-choice questions, using a Likert scale with five levels of intensity. The questionnaire consisted of mostly closed-ended questions, where respondents could choose from several answers. Also, a linear scale was used that allowed the respondents to determine the degree of agreement with the stated statements, which enabled a more precise measurement of their attitudes and preferences. This combination of different types of questions enabled a detailed analysis of Generation Z's behavior and attitudes regarding the zero moment of truth. In the primary data analysis, descriptive statistical analysis and multivariate statistical analysis (multiple regression method) were used to determine the direction and strength of correlation between the observed variables and to confirm differences in behavior. A descriptive analysis was carried out to create customer profiles. The method of data analysis was carried out in the Excel software package, and the results were presented in the form of tables and graphs. The goal is to investigate how different generations use available digital information and which sources they consider the most reliable and influential in their decision-making process in order to better understand the differences and similarities between generations in the context of digital search and shopping, with a special focus on members of Generation Z. The starting assumption of this research is that members of Generation Z will spend more time on the Internet per day, use digital sources of information to a much greater extent than older generations (X and Y) when making purchase decisions, and that they will not be sentimentally attached to the brand when making a decision about the



purchase. Furthermore, it is expected that generation Z will give greater importance to the influence of social networks and online reviews and thus create an online opinion about the product used. Also, it is assumed that members of generation Z will avoid traditional means of communication when making a purchase decision, such as direct communication with a sales representative or SMS messages, but will look more at information obtained outside of direct contact with the seller of a product or service. Based on the mentioned assumptions, a hypothesis was created.

Hypothesis 1. Marketing tools affect differently on different generations  
The results of the analysis are given in the chart below.

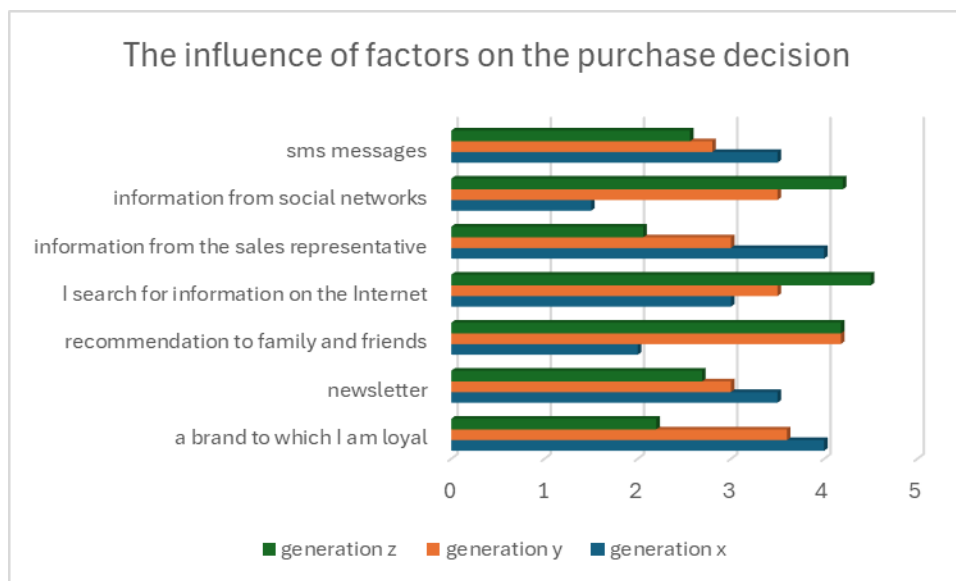

Figure 1: The influence of factors on the purchase decision (Source: made by the authors)

It is clear from the results that each generation has specific priorities and preferences when making purchasing decisions, which reflects their unique lifestyles and ways of interacting with technology and information. Generation X, which grew up in the era before the digital revolution, still values traditional sources of information and personal experiences the most. This can be seen in their strong reliance on the brands they grew up with and their communication with sales representatives, suggesting that they have more confidence in the familiar and tangible. They are also less likely to use mobile devices to research product information, showing less dependence on technology compared to younger generations. On the other hand, Generation Y proves to be the generation that is most adapted to new technologies and digital marketing. They often use mobile devices to research products and are also very likely to interact with brands through social networks. This generation is extremely sensitive to online recommendations and reviews, which shows that they are aware and inclined to take advantage of the information available online. Their tendency to receive newsletters and other digital forms of communication from manufacturers indicates an openness to personalized marketing messages. Generation Z shows the highest dependence on online platforms and social networks when making purchasing decisions. Their tendency to search for information and communicate via mobile devices surpasses even Generation Y. For this generation, speed and availability of information are key factors. However, they are less associated with childhood brands, which may indicate a greater willingness to try new brands and products that are popular on social media.

Based on the above indicators, it was decided to additionally analyze the factors that influence the purchase decision of generation Z, with a special focus on ZMOT. A hypothesis was put forward

Hypothesis 2. ZMOT has a significant influence on the purchase decision of generation Z

For the analysis of hypothesis H2, it was necessary to define a sample of members of generation Z, and from the conducted research, that sample is (n = 89). The goal was to analyze which factors influenced their behavior and to determine the strength of the correlation between consumer behavior and the factors that influenced their behavior. Multivariate regression shows the intensity of influence of each of these factors on the purchase of Generation Z users.

#### SUMMARY OUTPUT

<i>Regression Statistics</i>	
Multiple R	0,88261
R Square	0,758992
Adjusted R Square	0,687182
Standard Error	0,384563
Observations	89

#### ANOVA

	<i>df</i>	<i>SS</i>	<i>MS</i>	<i>F</i>	<i>Significance F</i>
Regression	4	32,34053	8,085133	51,41179	8,13E-22
Residual	84	13,21003	0,157262		
Total	88	45,55056			

	<i>Coefficients</i>	<i>Standard Error</i>	<i>t Stat</i>	<i>P-value</i>	<i>Lower 95%</i>	<i>Upper 95%</i>	<i>Lower 95,0%</i>	<i>Upper 95,0%</i>
Intercept	-0,5812	0,3759	-1,5462	0,1228	-1,3286	0,1663	-1,3286	0,1663
Information from social networks	0,3523	0,0965	3,7269	0,0004	0,1688	0,5478	0,1688	0,5478
People's recommendations	0,1052	0,0989	1,0419	0,2750	-0,0876	0,2970	-0,0866	0,2970
Information on the Internet	0,2347	0,1157	2,0152	0,0584	0,0015	0,4139	0,0015	0,4139
ZMOT	0,5213	0,0974	4,1204	0,0002	0,2306	0,5119	0,1206	0,5119

Table 1: The influence of factors on the purchase decision (Source: made by the authors)

It is evident from the table how the users react significantly to the marketing tools that are used to direct the purchase decision to members of the Z generation. More specifically, buying intensity will increase by 0.5213, at the 5% significance level, if ZMOT increases by one and other variables remain unchanged. Thus, it can be determined that ZMOT will have the most intensive influence on purchases in generation Z in the future. It is also important to mention the influence of social networks on purchases. Namely, if the intensity of influence on social networks increases by one point, and other variables remain unchanged, then the intensity of purchase will increase by 0.3523, with a significance level of 5%. Finally, if information gathered from the Internet increases by one point, and other variables remain unchanged, then the intensity of purchase will increase by 0.2347, with a significance level of 5%. Furthermore, the results of the group F test (F=8, 13E-22) show that the regression model is significant with a significance level of 5%. The value of the multiple correlation coefficient (R=0.88261) indicates the existence of a strong relationship between purchase as a dependent variable and independent variables.

The variance of the purchase decision of 75% among the observed 89 respondents was interpreted using the above values, so it can be concluded that the regression analysis confirmed a strong connection between the components.

## 6. CONCLUSION

The research conclusion points to key aspects of Gen Z behavior during the Zero Moment of Truth (ZMOT) decision-making process, which has significant implications for marketing strategies targeting this demographic. Generation Z relies heavily on mobile devices when researching products and services and spends significantly more time online than older generations, which points to the need for brands to adapt their digital strategies to ensure a seamless mobile experience. This mobile research trend requires content optimization for mobile platforms, where information must be presented in a clear, accessible and intuitive way. In addition, Generation Z shows a high level of awareness and attention in the decision-making process, often searching for information before deciding to make a purchase. This behavior highlights the importance of brands' presence in the digital space, where relevant and compelling content, such as user reviews and video demonstrations, can significantly influence the final purchase decision.

### LITERATURE:

1. Arndt, J. (1967) Role of Product-Related Conversations in the Diffusion of a New Product, *Journal of Marketing Research*, (4), pp. 291-295. <https://doi.org/10.2307/3149462>.
2. Brown, B. C. (1965). *The Complete Guide to Affiliate Marketing on the Web: How to Use and Profit from the affiliate marketing programs*. Ocala, Florida: Atlantic Publishing Group, Inc.
3. Cheung, C. M. K., Thadani, D. R. (2010) The Effectiveness of Electronic Word-of-Mouth Communication: A Literature Analysis. *BLED 2010 Proceedings, AISeL*, (18), pp. 329-345. Retrieved 03.08.2024. from [researchgate.net/publication/221229599\\_The\\_State\\_of\\_Electronic\\_Word-Of\\_Mouth\\_Research\\_A\\_Literature\\_Analysis](https://www.researchgate.net/publication/221229599_The_State_of_Electronic_Word-Of_Mouth_Research_A_Literature_Analysis).
4. *DOKAZANO: Generacije X, Y in Z se pomembno razlikujejo v nakupnih navadah!*. (2017). Retrieved 03.07.2024. from <https://smind.si/generacije-x-y-in-z-se-pomembno-razlikujejo-v-nakupnih-navadah/>.
5. Ertemel, A., Koksal G. (2017) EFFECTS OF ZERO MOMENT OF TRUTH ON CONSUMER BEHAVIOR FOR FMCG, *7th International Conference of Strategic Research on Social Science and Education (ICoSReSSE)*, pp. 463-475. Retrieved 03.07.2024. from [https://www.researchgate.net/publication/326462966\\_EFFECTS\\_OF\\_ZERO\\_MOMENT\\_OF\\_TRUTH\\_ON\\_CONSUMER\\_BEHAVIOR\\_FOR\\_FMCG](https://www.researchgate.net/publication/326462966_EFFECTS_OF_ZERO_MOMENT_OF_TRUTH_ON_CONSUMER_BEHAVIOR_FOR_FMCG).
6. Ferguson, R. (2008) Word of mouth and viral marketing: Taking the temperature of the hottest trends in marketing, *Journal of Consumer Marketing*, 25(3), pp. 179-182. Retrieved 03.08.2024. from [https://www.researchgate.net/publication/235283079\\_Word\\_of\\_mouth\\_and\\_viral\\_marketing\\_Taking\\_the\\_temperature\\_of\\_the\\_hottest\\_trends\\_in\\_marketing](https://www.researchgate.net/publication/235283079_Word_of_mouth_and_viral_marketing_Taking_the_temperature_of_the_hottest_trends_in_marketing).
7. Harrison-Walker, L. J. (2001) The measurement of word-of-mouth communication and an investigation of service quality and customer commitment as potential antecedents, *Journal of Service Research*, (4), pp. 60-75. Retrieved 03.07.2024. from <https://journals.sagepub.com/doi/10.1177/109467050141006>.

8. Hennig-Thurau, T., Gwinner, K. P., Walsh, G., Gremler, D. D. (2004) Electronic word-of-mouth via consumer-opinion platforms: what motivates consumers to articulate themselves on the Internet?, *Journal of Interactive Marketing*, 18(1), pp. 38-52. Retrieved 03.08.2024. from [https://www.researchgate.net/publication/227606375\\_Electronic\\_word-of-mouth\\_via\\_consumer-opinion\\_platforms\\_What\\_motivates\\_consumers\\_to\\_articulate\\_themselves\\_on\\_the\\_Internet](https://www.researchgate.net/publication/227606375_Electronic_word-of-mouth_via_consumer-opinion_platforms_What_motivates_consumers_to_articulate_themselves_on_the_Internet).
9. Herr, P. M., Kardes, F. R., Kim, J. (1991) The effects of word-of-mouth and product attribute information on persuasion: An accessibility-diagnostics perspective. *Journal of Consumer Research*, 17(4), pp. 454-462. Retrieved 03.08.2024. from [https://www.academia.edu/9375044/Managing\\_negative\\_word\\_of\\_mouth\\_an\\_exploratory\\_study\\_JMM\\_2014](https://www.academia.edu/9375044/Managing_negative_word_of_mouth_an_exploratory_study_JMM_2014).
10. King, C. W., Summers, J. O. (1970) Overlap of Opinion Leadership across consumer product categories, *Journal of Marketing Research*, (7), pp. 43-50. Retrieved 03.08.2024. from <https://link.springer.com/article/10.1007/s11002-015-9369-7>.
11. Kraljević, R., Gujić, M., Milun, T. (2016) PODUZETNICI I NOVA KOMUNIKACIJSKA TEHNOLOGIJA: ZAPREKE ILI IZAZOVI, *Acta Ecibinuca Et Tzrustuca*, Vol. 1 No. 2, pp. 159-176. Retrived 14.05.2024. from <https://hrcak.srce.hr/file/236097>.
12. Lecinski, J. (2011) *Winning the Zero Moment of Truth: ZMOT*. Google. Retrieved 13.09.2024. from <https://www.thinkwithgoogle.com/marketing-strategies/automation/2011-winning-zmot-ebook/>.
13. Litvin, S.W., Goldsmith, R.E., Pan, B. (2008) Electronic word-of-mouth in hospitality and tourism management, *Tourism Management*, (29), pp. 458-468. Retrieved 03.08.2024. from [https://www.researchgate.net/publication/222394083\\_Electronic\\_Word-of-Mouth\\_in\\_Hospitality\\_and\\_Tourism\\_Management](https://www.researchgate.net/publication/222394083_Electronic_Word-of-Mouth_in_Hospitality_and_Tourism_Management).
14. Mahfooz, H. (2024) Influencing shopper behavior at the zero moment of truth, *Addaiyan Journal of Arts, Humanities and Social Sciences*, 26(07), pp. 33-53. Retrieved 13.09.2024. from [https://aipublisher.org/resources/article\\_documents/article\\_docajahss.6.7.5.pdf](https://aipublisher.org/resources/article_documents/article_docajahss.6.7.5.pdf).
15. Matheja, I. (2014) *Development analysis of publishers in online affiliate marketing* (Master Thesis). Ludwig-Maximilians-Universität München: [I. Matheja].
16. *Online shopping cart abandonment rate worldwide between 2006 to 2024*. (2024). Retrieved 20.08.2024. from <https://www.statista.com/statistics/477804/online-shopping-cart-abandonment-rate-worldwide/>.
17. Reibstein, D., Mintz, O., Bart, Y., Lenk, P. (2019) Drowning in Metrics: How Managers Select and Trade-off Metrics for Making Marketing Budgetary Decisions, *SSRN Electronic Journal*, doi:10.2139/ssrn.3502600.
18. Subashini S. (2024). Evolution of the Zero Moment of Truth Concept: Analyzing the Historical Development and Conceptual Evolution of the ZMOT Framework in Marketing Literature, *Addaiyan Journal of Arts, Humanities and Social Sciences*, 6(07), pp. 33-53. Retrieved 13.09.2024. from [https://www.researchgate.net/publication/380701414\\_Evolution\\_of\\_the\\_Zero\\_Moment\\_of\\_Truth\\_Concept\\_Analyzing\\_the\\_Historical\\_Development\\_and\\_Conceptual\\_Evolution\\_of\\_the\\_ZMOT\\_Framework\\_in\\_Marketing\\_Literature](https://www.researchgate.net/publication/380701414_Evolution_of_the_Zero_Moment_of_Truth_Concept_Analyzing_the_Historical_Development_and_Conceptual_Evolution_of_the_ZMOT_Framework_in_Marketing_Literature).
19. Tseng, C. H., Kuo, H. C., Chen, J. M. (2014) Do Types of Virtual Community Matter for the Effects of Online Advertisement and Electronic Word of Mouth?, *Marketing Review*, 11(1), pp. 29-50. Retrieved 03.07.2024. from [https://www.researchgate.net/publication/282646865\\_Do\\_Types\\_of\\_Virtual\\_Community\\_Matter\\_for\\_the\\_Effects\\_of\\_online\\_Advertisement\\_and\\_Electronic\\_Words\\_of\\_Mouth](https://www.researchgate.net/publication/282646865_Do_Types_of_Virtual_Community_Matter_for_the_Effects_of_online_Advertisement_and_Electronic_Words_of_Mouth).
20. Weisfeld-Spolter, S., Sussan, F., Gould, S. (2014) An integrative approach to eWOM and marketing communications, *Corporate communications: An international Journal*, 19 (3), pp. 260-274. Retrieved 03.08.2024. from [https://www.researchgate.net/publication/265856998\\_An\\_integrative\\_approach\\_to\\_eWOM\\_and\\_marketing\\_communications](https://www.researchgate.net/publication/265856998_An_integrative_approach_to_eWOM_and_marketing_communications).

21. *ZMOT – multi trenutak istine.* (2012). Retrieved 03.07.2024. from <https://branddumine.wordpress.com/2012/11/01/zmot-multi-trenutak-istine/>.
22. 49 Cart Abandonment Rate Statistics 2024 (2024). Retrieved 20.08.2024. from <https://baymard.com/lists/cart-abandonment-rate>.

# DECODING ORGANIZATIONAL DYNAMICS: THE INTERSECTION OF LISTENING-BASED EMOTIONAL INTELLIGENCE AND SOCIAL AWARENESS IN DECISION-MAKING

**Morena Paulisic**

*Faculty of Economics and Tourism 'Dr. Mijo Mirkovic'  
Juraj Dobrila University of Pula, Pula, Croatia  
morena.paulisic@unipu.hr*

**Katarina Kostelic**

*Faculty of Economics and Tourism 'Dr. Mijo Mirkovic'  
Juraj Dobrila University of Pula, Pula, Croatia*

**Maja Doja**

*Faculty of Economics and Tourism 'Dr. Mijo Mirkovic'  
Juraj Dobrila University of Pula, Pula, Croatia*

## **ABSTRACT**

*Organizations rely on relationships and social interaction. One of the key factors is communication, where emotions and emotional comfort become the key to the success of organizational dynamics. Listening as a part of emotional intelligence deserves special attention because conflicts, bad mental conditions, etc. in organizations often arise due to failure to listen to the individual's state and failure to pay attention to elements of the environment that create pressure on listening. Due to the evidence that every conversation can result in several different emotional states, especially for managers, it is important to take care of emotional intelligence and social awareness when making and communicating decisions. This paper aims to identify the intersection of listening-based emotional intelligence and social awareness in decision-making in organizational dynamics. In this study, respondents generally reported lower difficulties in recognizing and expressing emotions, with notable exceptions in specific contexts, such as interpreting others' emotions in noisy situations or when multiple conversations are happening. For organizations, these findings can be useful for developing targeted interventions to enhance emotional intelligence and social awareness in decision-making. The presented model (CFA) of emotional intelligence related to listening/hearing is valid and reliable, where environmental factors play a crucial role. We found that emotional intelligence, through its social awareness component achieved by listening/hearing, plays a crucial role in decision-making, especially in interactive environments. Extending these theoretical implications into business decision-making presents a nuanced understanding of how emotional intelligence (EI) can profoundly influence organizational strategies and outcomes, particularly through listening and hearing.*

**Keywords:** *Emotional Intelligence, Organizational Dynamics, Social Awareness*

## **1. INTRODUCTION**

Organizational dynamics positively impacted by emotional listening and listening include managing emotional and cognitive responses during radical change (COVID-19, AI in the workplace, etc.), influencing the success of process implementations, and navigating sensitive, emotional territories during fundamental shifts in emotional culture and skills.

By actively managing the emotions associated with change, organizations can improve employee engagement, adaptability, and effectiveness in implementing organizational change. Emotional reflexivity is key in fostering successful organizational change by appreciating and addressing employees' emotional reactions, ultimately contributing to a more resilient and adaptable organizational culture. (Kralj 2010) Emotional reflexivity, supported by listening, is crucial for managing emotional responses caused by organizational change. By addressing these emotions, organizations can ensure easier implementation of change initiatives (King, 2010). Empathic listening encourages self-reflection and problem-solving, enabling employees to contribute more effectively to organizational learning and innovation (Marques et al., 2011). Although emotional listening and hearing have many benefits, it is important to recognize that not all organizational environments are equally receptive to this practice. In some cases, cultural or structural barriers may prevent the effective implementation of an emotional listening strategy. Therefore, organizations must adapt their approaches to their unique contexts, and employee needs to maximize the positive effects of emotional listening and hearing. The key research question of this paper is how social awareness, especially listening, as part of EI, contributes to better decision-making and ultimately affects organizational dynamics. Our study contributes a deeper understanding of how specific EI competencies influence leadership effectiveness and decision-making. This complements existing research by offering a more nuanced view of how different aspects of EI can affect the quality of strategic decisions in organizations.

Empathetic leaders, who are a product of high EI, can motivate and engage their staff, improving workplace communication and performance. This is crucial for making informed and effective decisions in complex situations (Sharma et al., 2023). EI is linked to rational and intuitive decision-making styles, suggesting that emotionally intelligent managers can balance cognitive and emotional components to make better decisions. This balance is essential for effective communication during decision-making processes (Khalisah, 2023). The ability of individual to manage emotions helps in resolving conflicts amicably and sustaining a positive work environment, which is vital for clear and effective communication during decision-making proces (Kargeti, 2023). Emotional listening and hearing are crucial in enhancing various organizational dynamics, fostering a more inclusive, committed, and innovative workplace. By effectively leveraging emotions, organizations can navigate strategic transformations and improve employee engagement and performance. The following sections explore the specific organizational dynamics positively impacted by emotional listening and hearing; the researched model is presented and gives some insights into possible recommendations for practice and future research.

Organizational dynamics positively impacted by emotional listening and hearing include managing emotional and cognitive responses during radical change, influencing the success of implementation processes, and navigating sensitive emotional territories during fundamental shifts in emotional culture and skills. By actively managing emotions associated with change, organizations can enhance employee engagement, adaptability, and effectiveness in implementing organizational change. Emotional reflexivity plays a crucial role in fostering successful organizational change by acknowledging and addressing employees' emotional responses, ultimately contributing to a more resilient and adaptive organizational culture. (King 2010) As a management tool, empathetic listening helps leaders address employee dissatisfaction and stress, reducing turnover rates (Marques et al., 2011).

Emotional reflexivity, facilitated by listening, is essential for managing the emotional responses triggered by organizational change. By addressing these emotions, organizations can ensure smoother implementation of change initiatives (King, 2010). Empathetic listening encourages self-reflection and problem-solving, enabling employees to contribute more effectively to organizational learning and innovation (Marques et al., 2011). While emotional listening and hearing have numerous benefits, it is important to recognize that not all organizational environments may be equally receptive to these practices. In some cases, cultural or structural barriers may hinder the effective implementation of emotional listening strategies. Therefore, organizations must tailor their approaches to fit their unique contexts and employee needs to maximize the positive impacts of emotional listening and hearing. Our study contributes a deeper understanding of how specific EI competencies influence leadership effectiveness and decision-making. This complements the existing research by offering a more nuanced view of how different facets of EI can impact the quality of strategic decisions in organizations.

## **2. THEORETICAL OVERVIEW**

The relationship between organizational dynamics and employee well-being is multifaceted, with significant implications for decision-making, workplace productivity, and employee satisfaction. Organizational dynamics, such as innovation, adaptability, and strategic orientation, positively correlate with employee mental health, while emotional intelligence and effective listening play crucial roles in fostering a supportive work environment. These elements collectively contribute to enhancing employee well-being and organizational effectiveness. (Varikunta & Kamal, 2024). Listening and emotional intelligence contribute to a positive work environment by fostering supportive work environments, organizational justice, and fair perceptions, ultimately enhancing employee well-being. (Murphy, 2024)

### *2.1. Emotional intelligence through listening*

Emotional listening shapes relationships and social dynamics by influencing behavioural responses, emotional recovery, and social integration. The process involves complex neurochemical and cognitive mechanisms that affect how individuals perceive and react to emotional vocalizations and narratives. Emotional listening can significantly affect relationships and social dynamics by shaping how individuals interpret and respond to vocal emotional cues (Ghasemahmad et al., 2024). Emotional listening also involves social sharing, where individuals disclose their emotions to others. The listener's response mode significantly impacts the benefits of this sharing. A socio-affective response can enhance social integration and reduce loneliness, while a cognitive response can facilitate emotional recovery and cognitive restructuring (Nils & Rimé, 2012). Emotional listening requires rapid decoding of vocal emotions, which involves involuntary and cognitive appraisal processes. These processes are influenced by individual differences and social contexts, highlighting the adaptive nature of emotional listening in social interactions (Paulmann & Kotz, 2018). While emotional listening generally fosters positive social dynamics, it can also lead to increased aversive behaviors if the emotional content is distressing or if the listener's internal state is not conducive to positive engagement (Ghasemahmad et al., 2024). Understanding these dynamics can help develop strategies to enhance emotional communication and strengthen social bonds. Organizational dynamics, such as innovation, adaptability, and strategic orientation, positively correlate with employee mental health, while emotional intelligence and effective listening play crucial roles in fostering a supportive work environment.



For example, effective listening within teams is vital for enhancing team dynamics, especially in hybrid work environments while listening and communication are key to leveraging team dynamics for organizational success (Rahmatullah et al., 2024).

Emotional listening enhances understanding, empathy, and connection between individuals, positively influencing relationships and social dynamics. Individuals can build trust, improve communication, and foster a supportive environment by actively engaging in empathetic listening. This listening not only helps in comprehending others' emotions but also contributes to creating a more harmonious and cooperative social atmosphere, ultimately strengthening relationships and enhancing social interactions. (Caitlin et al., 2021). Emotional listening, characterized by empathic and supportive responses, can enhance relationships and social dynamics by fostering emotional recovery, shattered assumptions consolidation, social integration, and temporary distress reduction. The study suggests that sharing emotions with listeners who adopt cognitive reframing responses leads to emotional recovery and cognitive benefits. In contrast, socio-affective responses promote social integration and a sense of feeling better. These findings highlight the significant role of the listener's response mode in determining the benefits of emotional disclosure on relationships and social interactions (Nils & Rimé, 2012).

### *2.2.Social awareness*

Focusing on the social awareness component as a bridge between emotional intelligence (EI) through listening/hearing and organizational decision-making draws upon several interdisciplinary theories and concepts. In the context of EI, social awareness entails the ability to understand and respond to the emotions of others, recognize social cues, and navigate social situations effectively. This ability is crucial in organizational settings, where understanding and managing interpersonal dynamics can significantly impact decision-making and overall organizational success. Listening/hearing can be instrumental in various decision-making contexts, spanning educational, organizational, clinical, and personal development areas. Understanding emotional intelligence, especially in listening and hearing, offers insights that can inform strategies to enhance communication, leadership, conflict resolution, and overall interpersonal effectiveness. Hussain et al. (2020) suggest that emotional awareness is crucial for understanding others' perspectives, as it allows individuals to empathize and connect with others' emotions. A study on university students highlighted the importance of emotional awareness in enhancing self-confidence and behavior, which are essential for social interactions. Social perception, a component of emotional intelligence, involves understanding emotions and motives, significantly impacting listening and reading comprehension. This understanding is vital for interpreting conversations and stories, enhancing social awareness (Froiland & Davison, 2020). In theory, Mayer and Salovey's Model of Emotional Intelligence categorizes EI into four abilities: (1) *perceiving emotions*, (2) *using emotions to facilitate thought*, (3) *understanding emotions*, and (4) *managing emotions*. This model is particularly relevant in leadership contexts, where understanding and managing emotions can significantly affect leadership effectiveness, team dynamics, and organizational climate. Listening and hearing are crucial for perceiving emotions (recognizing emotions in oneself and others) and managing emotions (responding appropriately to one's and those of others). Within this model, social awareness primarily falls under the third branch: understanding emotions. This involves the capacity to comprehend emotional expressions and to appreciate complicated relationships among emotions. In organizational contexts, this ability allows leaders and employees to

interpret accurately and respond to the emotions of colleagues, customers, and other stakeholders. (Salovey et al., 2003) On the other hand, Goleman's Emotional Competencies Framework Goleman (1998) expanded the initial concept of EI (Goleman, 1995) to include a set of emotional competencies grouped under personal competence (self-awareness, self-regulation, and motivation) and social competence (social awareness and relationship management). Listening, within the context of EI in the workplace, is not just about hearing words but involves actively understanding the information being shared, recognizing the emotions behind the words, and responding appropriately. This active listening is crucial for empathy, as it allows one to perceive and understand others' feelings and perspectives. Effective listening, a social awareness component, is foundational for relationship management, influencing leadership effectiveness, and team dynamics. Goleman identifies social awareness as encompassing empathy, organizational awareness, and service orientation. Empathy, the ability to understand and share the feelings of another, is foundational for effective leadership, teamwork, and customer relations. Organizational awareness refers to understanding an organization's emotional currents and power relationships. Service orientation involves anticipating, recognizing, and meeting customers' needs. (Goleman, 2021, Williams, 2021, Drigas & Papoutsis, 2021, Aamir, 2023, Johennesse & Pressley, 2023)

### *2.3. Linking social awareness to organizational decision-making*

In practice, linking social awareness and organizational decision-making is in focus primarily because of environmental pressure (SGS goals, etc.) and new leadership insights that are changing managerial mindsets. Tourangeau's insights (Tourangeau, 2015) on transformational leadership are through the intricate ways leaders use not just the content of their speech but its emotional undertones, conveyed through prosody, to connect with and influence their followers. The original study posits that transformational leaders, known for their capacity to inspire and evoke high levels of performance and loyalty from their followers, might leverage specific prosodic features in their speech—such as pitch, volume, intonation, and speech rate—to engender trust, respect, and emotional alignment. By emphasizing social awareness achieved through listening/hearing, research implies that transformational leadership is not only about how leaders speak but also about how attentively they listen and how adeptly they interpret and respond to the emotional cues of their followers. This approach introduces a complementary perspective to the existing literature, which predominantly focuses on the expressive aspects of emotional intelligence, by highlighting the receptive, interpretative aspects that are equally vital for leadership effectiveness. In the same consistency, Görgens-Ekermans & Roux (2021) suggest that leaders attuned to their own and others' emotions through effective listening and social awareness are more likely to engage in transformational behaviors. A comprehensive framework for leadership decision-making in complex systems (Hallo et al., 2020) recognizes the importance of addressing volatility, uncertainty, complexity, and ambiguity (VUCA) in the modern business environment. Their focus on social awareness, particularly through listening/hearing, complements this framework by highlighting the critical role of understanding and navigating interpersonal dynamics and stakeholder perspectives in complex decision-making processes. Johennesse and Pressley's review (Johennesse & Pressley, 2023) emphasizes the multifaceted nature of EI, including self-awareness, self-management, motivation, empathy, and social skills. They build upon the insights provided in the study (Tourangeau, 2015) on transformational leadership by exploring the intricate ways leaders use the content of their speech and its emotional undertones, conveyed through prosody, to connect

with and influence their followers. The original study posits that transformational leaders, known for their capacity to inspire and evoke high levels of performance and loyalty from their followers, might leverage specific prosodic features in their speech—such as pitch, volume, intonation, and speech rate—to engender trust, respect, and emotional alignment. By emphasizing social awareness achieved through listening/hearing, research implies that transformational leadership is not only about how leaders speak but also about how attentively they listen and how adeptly they interpret and respond to the emotional cues of their followers. This approach introduces a complementary perspective to the existing literature, which predominantly focuses on the expressive aspects of emotional intelligence, by highlighting the receptive, interpretative aspects that are equally vital for leadership effectiveness. The authors deduce the relationship between emotional intelligence (EI) and firm performance through a multi-faceted approach that integrates findings from various studies and theoretical frameworks and applies EI principles in organizational contexts. The study begins with Mayer's definition of emotional intelligence, emphasizing the ability to recognize, understand, and manage emotions. This foundational concept sets the stage for exploring how such abilities influence workplace dynamics and outcomes. They identify core characteristics of EI—motivation, discipline, openness, and inventiveness—as critical for enhancing organizational creativity, decision-making, and strategy development. By linking these traits to improved problem-solving and decision-making, the authors suggest that individuals with high EI contribute more effectively to their organizations' goals. They conclude that for organizations to enhance their performance, they should prioritize the development of EI and cognitive abilities within their workforce. By doing so, firms can foster an environment where employees are better equipped to handle challenges, innovate, and make strategic decisions that align with organizational growth objectives. Listening/hearing is a component of "Social awareness" and potentially "Social skills," which also agrees with Drigas and Papoutsis (2021) in the Nine-Layer Pyramid Model. It emphasizes recognizing, understanding, and appropriately responding to others' emotions. By exploring these competencies in-depth, research can provide a more nuanced understanding of how individuals navigate interpersonal dynamics and build effective relationships. (Drigas & Papoutsis, 2021)

A review by Yip and Fisher (2022) uncovers the fragmented landscape of listening research across management, psychology, and communication studies, identifying three distinct perspectives on listening: perceived listening, the listener's experience, and listening structures. This fragmentation has led to a gap in understanding the integrated role of listening within the broader construct of EI in organizations. The research contributes to bridging this gap by emphasizing the auditory aspects of EI and detailing how different factors of social awareness, achieved through listening, impact organizational dynamics and decision-making. Specifically, the study's focus on recognizing and understanding emotions through auditory cues enriches the dialogue on perceived listening and the listener's experience by highlighting how these processes are crucial for effective EI in the workplace.

The study by Fedorova et al. (2023) introduces tools for developing EI in general and social awareness as one of its components, such as exercises for reading others' emotions. This research on social awareness can further this by offering more profound insights into how individuals can better interpret and respond to the emotions heard by others in a business context. For instance, incorporating listening exercises that simulate real-life business negotiations or team conflicts can help learners practice and improve their empathetic listening and conflict-resolution skills.

The research by Muhammad Junaid Ahsan focuses on the role of Emotional Intelligence (EI) in fostering effective Corporate Social Responsibility (CSR) leadership. It argues that for leaders to implement CSR initiatives successfully, they must exhibit high levels of EI. The study underlines the significance of traits such as self-awareness, self-management, social awareness, and relationship management, highlighting how these components of EI are integral for leaders aiming to navigate the complexities of CSR effectively. Ahsan's research contributes to understanding how EI influences CSR leadership, a relatively underexplored area within leadership studies. The research distinguishes which aspects of EI are most beneficial for CSR leadership. While general leadership might require a broad range of EI competencies, Ahsan's study suggests that certain EI traits, such as empathy and social skills, are particularly crucial for CSR leadership.

### 3. METHODS

The data was collected in 2021 a professional context through an online questionnaire. The questionnaire used (Table 1A) The Emotional Communication in Hearing Questionnaire (EMO-CHeQ) is a tool designed to assess how individuals perceive vocal emotion information, has been previously used and is a reliable and ecologically valid measure for assessing experiences of hearing and handicap when listening to vocal emotion signals. The questionnaire's development involved rigorous testing, including exploratory and confirmatory factor analyses, which ensured its construct validity and internal consistency (Singh et al., 2024; Toker et al., 2023). The Turkish version of the EMO-CHeQ demonstrated high reliability, with a Cronbach's alpha of 0.949, indicating strong internal consistency. This suggests that the questionnaire can reliably capture self-reported data across cultural contexts (Toker et al., 2023)

The sample comprises 392 responses. The respondents are, on average, 21.84 years old, with a standard deviation of 21.12 years. The youngest is 18 years old, and the oldest is 80. 37.2449% of the respondents express themselves as male, 62.5% as female, and 0.2551% as non-binary sex.

In this study, we employed a comprehensive analytical approach to explore our dataset's structure and validate the underlying constructs related to emotional intelligence by listening/hearing. Initially, Principal Component Analysis (PCA) was conducted to identify the latent components within our data. The PCA was based on the correlation matrix, with component retention guided by eigenvalue criteria, specifically using parallel analysis as recommended by Hayton et al. (2004), and further supported by methodological insights from James et al. (2013), as well as Osborne et al. (2008). An oblique prom ax rotation was applied to facilitate the interpretation of the components, acknowledging the potential correlation between factors, as outlined in the tutorial on PCA by Shlens (2014). Following the exploratory phase, Confirmatory Factor Analysis (CFA) was performed to test the model structure elucidated by PCA, employing the Diagonally Weighted Least Squares (DWLS) estimator. This choice was made to accommodate the survey data's ordinal nature and address potential violations of multivariate normality, consistent with best practices in structural equation modeling (SEM) literature (Saris et al., 2009; Rosseel, 2012). The DWLS estimator is particularly suitable for dealing with non-normal distributions and ordinal data, ensuring robust standard errors and chi-square statistics. All variables were standardized before analysis, employing bootstrap confidence intervals (CIs) for error calculation as a robust, non-parametric approach that does not rely on the assumption of normality for the distribution of the estimator to estimate the precision and reliability of the model parameters. This analytical process was

facilitated by using JASP (Version 0.16.4), as documented by (Love et al., 2019). Building upon the foundational analyses, we expanded our methodological approach to include a hierarchical confirmatory factor analysis (HCFA). This advanced modeling technique was employed to investigate the structure of social awareness as a higher-order construct underpinned by the four first-order factors identified through our initial CFA. This second-level model posits social awareness as an overarching factor that is represented by, and contributes to, the integration of the distinct but related dimensions of emotional intelligence identified in the preliminary phase of our analysis.

The HCFA was conducted to assess the validity of conceptualizing social awareness as a composite construct, reflecting the aggregate influence of the first-order factors. This second-order factor analysis allows for a nuanced understanding of how specific aspects of emotional intelligence coalesce to form broader social awareness capabilities. The modeling process involved specifying a hierarchical structure wherein the first-order factors serve as observable indicators of the latent second-order factor, thereby testing the hypothesis that these specific domains of emotional intelligence collectively embody the construct of social awareness.

This hierarchical model was evaluated using the same robust DWLS estimator to ensure consistency and appropriateness, given the ordinal nature of our data and the potential for non-normality. The choice of estimator and modeling strategy was guided by the principles outlined in the structural equation modeling literature Rosseel (2012) and facilitated by the analytical capabilities of JASP (Version 0.16.4, JASP Team (2023)), ensuring that our methodological approach remained grounded in established practices. Since JASP analyses are implemented in the R programming language (R Core Team, 2018b), it is important to note that the descriptive analysis was done using “stats” package (R Core Team, 2018a), while additionally packages used for PCA were “psych” (Revelle & Revelle, 2015) and “qgraph” (Epskamp et al., 2017), and for CFA “ggplot2” (Wickham et al., 2016), “lavaan” (Rosseel, 2012), “reshape2” (Wickham & Wickham, 2022), “semPlot” (Epskamp, 2015).

By incorporating a second-order factor into our analysis, we aimed to provide deeper insights into the theoretical framework of social awareness within the context of emotional intelligence, offering a more comprehensive understanding of its dimensions and their interrelationships.

## **4. RESULTS**

### *4.1. Descriptive statistics*

The descriptive statistics table for these survey questions provides a comprehensive overview of how the examined 390 respondents perceive their difficulties in recognizing and expressing emotions. The most frequent response to most questions is at the lower end of the scale (1 or 2), indicating that a significant number of respondents do not frequently experience difficulties related to emotional intelligence in listening/hearing, with exceptions in Q6, Q10, and Q11, where the mode shifts towards 4, suggesting more respondents experience difficulties in these areas.

Table. Descriptive statistics

Questions	Mode	Median	Mean	Std. Deviation	Skewness	Kurtosis	Minimum	Maximum
Q1	1	2	2.02	1.14	0.72	-0.83	1	5
Q2	1	2	2.34	1.19	0.47	-0.82	1	5
Q3	1	2	2.28	1.2	0.58	-0.78	1	5
Q4	3	3	2.68	1.29	0.21	-1.06	1	5
Q5	2	2	2.61	1.32	0.37	-1.06	1	5
Q6	4	3	3.12	1.28	-0.27	-1.02	1	5
Q7	3	3	2.83	1.26	0.04	-1.07	1	5
Q8	3	3	2.69	1.23	0.07	-1.09	1	5
Q9	2	2	2.59	1.21	0.19	-1.1	1	5
Q10	4	4	3.4	1.27	-0.55	-0.76	1	5
Q11	4	4	3.48	1.22	-0.64	-0.54	1	5
Q12	1	2	2.22	1.2	0.47	-1.04	1	5
Q13	1	2	2.17	1.14	0.55	-0.72	1	5
Q14	1	2	2.02	1.21	0.91	-0.36	1	5
Q15	1	1	1.88	1.15	1.12	0.2	1	5
Q16	1	2	2.02	1.18	0.82	-0.52	1	5

The median and mean values are relatively close across all questions, indicating a fairly symmetrical distribution of responses around the central tendency. The mean values range from 1.88 to 3.48, suggesting a variation in the degree of difficulty experienced across different areas, with Q10 and Q11 showing the highest mean values, indicating more pronounced difficulties in recognizing emotions in noisy environments or when multiple people are speaking. Standard deviations are relatively consistent, ranging from 1.14 to 1.32, which suggests a moderate spread of responses around the mean. This indicates variability in how respondents experience these difficulties but not an extreme variation. Positive skewness values suggest a right-skewed distribution (more scores on the lower end), seen in most questions except Q6, Q10, and Q11, which are left-skewed (more scores on the higher end), indicating that respondents tend to report higher difficulties, particularly in interpreting emotions accurately when others think they're angry (Q6), and in noisy environments or when someone else is speaking (Q10, Q11). Most questions have negative kurtosis values, suggesting a flatter distribution than a normal bell curve, with Q15 being an exception showing a positive kurtosis, indicating a more peaked distribution. This suggests a wider range of responses in most areas, with responses on Q15 more concentrated around the mean. All questions have the same minimum and maximum values (1 and 5), indicating that for every question, there are respondents who selected the full range of possible responses, from completely disagreeing to completely agreeing with the statement. Respondents generally report lower difficulties in recognizing and expressing emotions, with notable exceptions in specific contexts, such as interpreting others' emotions in noisy situations or when multiple conversations are happening. The variability in responses (as shown by standard deviation) and the range of skewness values suggest differences in individual experiences with emotional intelligence in listening/hearing. The left skewness in questions related to interpreting emotions in challenging listening environments (Q10, Q11)

and when others misinterpret their emotions (Q6) highlights areas where interventions or support might be particularly beneficial. Having explored the descriptive statistics of our dataset on emotional intelligence related to listening/hearing, we uncovered initial insights into how individuals perceive and express emotions in various contexts. This foundational analysis highlighted the variability and complexity inherent in our data, setting the stage for deeper exploration. As we transition to the next chapter, we introduce Principal Component Analysis (PCA). This advanced statistical technique allows us to reduce the dimensionality of our dataset while preserving its essential patterns. PCA will enable us to identify underlying factors that encapsulate the core aspects of emotional intelligence in listening/hearing, offering a clearer, more simplified view of how these elements interrelate and impact organizational dynamics and decision-making processes.

#### 4.2. Principal component analysis

In applying PCA to our dataset, we investigate the latent structures that define the nuances of listening and hearing as components of emotional intelligence. This process involves transforming our original variables into a new set of uncorrelated factors, known as principal components, which capture the maximum variance within the data. These components aim to reveal the fundamental dimensions of emotional intelligence by listening/hearing that play a critical role in organizational settings. The model's chi-squared test shows a value of 410.23 with 62 degrees of freedom and a p-value of less than .001 (Table). This significant p-value indicates that the model fits the data well, suggesting that the PCA has successfully captured meaningful patterns within the dataset.

Table. Chi-squared Test

	<b>Value</b>	<b>df</b>	<b>p</b>
Model	410.23	62	< .001

Table. Component Loadings

	<b>RC1</b>	<b>RC2</b>	<b>RC3</b>	<b>RC4</b>	<b>Uniqueness</b>
Q16	0.85				0.30
Q14	0.85				0.30
Q15	0.84				0.31
Q12	0.72				0.37
Q13	0.66				0.41
Q3		0.79			0.44
Q1		0.77			0.37
Q2		0.64			0.50
Q4		0.60			0.36
Q5		0.55			0.40
Q8			0.78		0.34
Q7			0.71		0.38
Q6			0.67		0.51
Q9			0.57		0.54
Q10				0.89	0.22
Q11				0.88	0.25

*Note.* Applied rotation method is promax.

The table lists how each question (Q1 to Q16) loads on four rotated components (RC1 to RC4), with the 'Uniqueness' indicating the variance in each variable that is unique and not shared with other variables. RC1 is primarily loaded by Q16, Q14, Q15, Q12, and Q13, indicating a component that might represent aspects of emotional self-awareness and management, as these questions relate to personal difficulties and feelings. Loaded by Q3, Q1, Q2, Q4, and Q5, RC2 suggests a component focused on understanding others' emotions, possibly indicating empathy or social insight. RC3 shows significant loadings from Q8, Q7, Q6, and Q9, which could be interpreted as the communication aspect of emotional intelligence, particularly in how emotions are expressed and perceived in speech. RC4 is composed of Q10 and Q11, indicating a distinct factor possibly related to the ability to recognize emotions in challenging environments (e.g., noise or multiple speakers). This PCA has effectively delineated different aspects of emotional intelligence into four components, each representing a unique facet of how individuals perceive, understand, and manage emotions in themselves and others. These findings can be particularly useful for developing targeted interventions to enhance specific areas of emotional intelligence, such as empathy training (RC2), communication skills enhancement (RC3), or strategies to improve emotional recognition in noisy environments (RC4).

The eigenvalues for the unrotated solution start with Component 1 having the highest value (5.30), explaining 33% of the variance. The cumulative variance explained by the four components together reaches 63% in the unrotated solution, which is quite substantial.

Table. Component Characteristics

	Unrotated solution			Rotated solution		
	Eigenvalue	Proportion var.	Cumulative	SumSq. Loadings	Proportion var.	Cumulative
Component 1	5.30	0.33	0.33	3.17	0.20	0.20
Component 2	2.16	0.14	0.47	2.39	0.15	0.35
Component 3	1.35	0.08	0.55	2.33	0.15	0.49
Component 4	1.18	0.07	0.63	2.11	0.13	0.63

After rotation (using the Promax method, suitable for assuming correlated components), the components explain slightly different proportions of variance, with their cumulative contribution being 63% as well. The rotation helps in better interpreting the components by maximizing high loadings and minimizing low ones, making each component represent more distinct concepts.



Figure. Scree plot

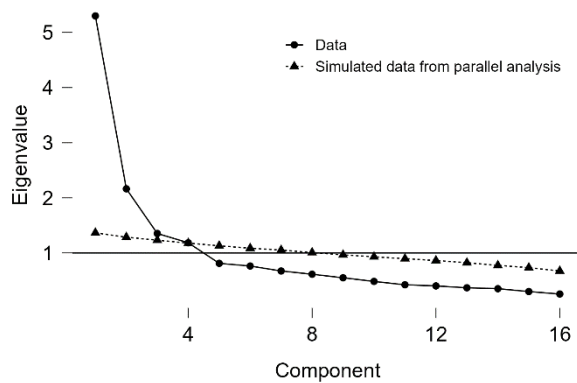

The Principal Component Analysis (PCA) has effectively unveiled a multidimensional structure of emotional intelligence related to listening/hearing, delineating distinct components that capture various facets of this complex construct. By simplifying the dataset and revealing underlying patterns, PCA provides a foundational understanding and a hypothesized model of the relationships between different aspects of emotional intelligence. However, while PCA offers valuable insights into potential structures, it is inherently exploratory and does not confirm the existence or strength of these relationships.

#### 4.3. Confirmatory factor analysis

To rigorously test and confirm the structure of emotional intelligence as suggested by our PCA results, we now turn to Confirmatory Factor Analysis (CFA). Unlike PCA, CFA allows us to specify a model a priori based on theoretical considerations and the exploratory findings from PCA and then assess how well our data fits this predefined structure. By conducting a CFA, we aim to validate the dimensions of emotional intelligence identified earlier, providing a more definitive understanding of its components and their interrelations. This step is crucial for affirming the reliability and validity of the constructs we have identified and ensuring that our model of emotional intelligence in listening/hearing is theoretically and empirically sound.

Table. Chi-square test

Model	X <sup>2</sup>	df	p
Baseline model	10828.17	120	
Factor model	245.84	98	< .001

The significant chi-square value for the factor model (245.84 with 98 degrees of freedom,  $p < .001$ ) indicates that the model is a good fit to the data, despite the chi-square test being sensitive to sample size (Table). The fit indices (Table) such as CFI (Comparative Fit Index = 0.99), TLI (Tucker-Lewis Index = 0.98), and RMSEA (Root Mean Square Error of Approximation = 0.06) suggest an excellent model fit. Values of CFI and TLI close to 1 and an RMSEA value closer to 0.05 reflect a model that closely approximates the observed data. The SRMR (Standardized Root Mean Square Residual = 0.06) further supports this, indicating a good fit between the hypothesized model and the observed covariance matrix.

Table. Fit indices and metrics

<b>Index</b>	<b>Value</b>
Comparative Fit Index (CFI)	0.986
Tucker-Lewis Index (TLI)	0.983
Bentler-Bonett Non-normed Fit Index (NNFI)	0.983
Bentler-Bonett Normed Fit Index (NFI)	0.977
Parsimony Normed Fit Index (PNFI)	0.798
Bollen's Relative Fit Index (RFI)	0.972
Bollen's Incremental Fit Index (IFI)	0.986
Relative Noncentrality Index (RNI)	0.986
<b>Metric</b>	<b>Value</b>
Root mean square error of approximation (RMSEA)	0.062
RMSEA 90% CI lower bound	0.053
RMSEA 90% CI upper bound	0.072
RMSEA p-value	0.0198
Standardized root mean square residual (SRMR)	0.062
Hoelter's critical N ( $\alpha = .05$ )	194.71
Hoelter's critical N ( $\alpha = .01$ )	212.74
Goodness of fit index (GFI)	0.986
McDonald fit index (MFI)	0.827

The estimates for factor loadings ( $\lambda$ ) are all significant ( $p < .001$ ), with estimates' CIs ranging from 0.55 to 0.90 across the four factors. This indicates that all items strongly relate to their respective factors, confirming the hypothesized structure. The high loadings on Q10 and Q11 for Factor 3 highlight a strong correlation with this factor, possibly indicating a distinct aspect of emotional intelligence related to environmental challenges.

Table. Factor loadings and R-squared

<b>Factor</b>	<b>Indicator</b>	<b>Symbol</b>	<b>Estimate</b>	<b>Std. Error</b>	<b>z-value</b>	<b>p</b>	<b>95% Confidence Interval Lower</b>	<b>95% Confidence Interval Upper</b>	<b>Std. Est. (all)</b>	<b>R<sup>2</sup></b>
Factor 1	Q1	$\lambda_{11}$	0.77	0.03	28.91	< .001	0.68	0.85	0.77	0.59
	Q2	$\lambda_{12}$	0.60	0.02	24.50	< .001	0.49	0.70	0.60	0.36
	Q3	$\lambda_{13}$	0.60	0.02	24.66	< .001	0.51	0.69	0.60	0.37
	Q4	$\lambda_{14}$	0.69	0.02	28.07	< .001	0.60	0.77	0.69	0.47
	Q5	$\lambda_{15}$	0.74	0.02	29.49	< .001	0.65	0.82	0.74	0.54
Factor 2	Q6	$\lambda_{21}$	0.61	0.02	24.52	< .001	0.51	0.7	0.61	0.37
	Q7	$\lambda_{22}$	0.79	0.02	32.01	< .001	0.71	0.86	0.79	0.62
	Q8	$\lambda_{23}$	0.75	0.02	31.04	< .001	0.67	0.83	0.75	0.56
	Q9	$\lambda_{24}$	0.62	0.02	25.30	< .001	0.51	0.72	0.62	0.38
Factor 3	Q10	$\lambda_{31}$	0.90	0.03	32.08	< .001	0.82	0.98	0.90	0.81
	Q11	$\lambda_{32}$	0.84	0.03	32.08	< .001	0.77	0.91	0.84	0.71
Factor 4	Q12	$\lambda_{41}$	0.81	0.02	38.66	< .001	0.75	0.86	0.81	0.65
	Q13	$\lambda_{42}$	0.78	0.02	38.19	< .001	0.71	0.83	0.78	0.60
	Q14	$\lambda_{43}$	0.85	0.02	42.63	< .001	0.79	0.89	0.85	0.72
	Q15	$\lambda_{44}$	0.81	0.02	40.74	< .001	0.73	0.87	0.81	0.66
	Q16	$\lambda_{45}$	0.80	0.02	39.35	< .001	0.75	0.85	0.80	0.64

The  $R^2$  values indicate the proportion of variance in each observed variable explained by the model, with values ranging from 0.36 to 0.81. Higher values, especially for Q10, Q11 and Q14, suggest that the model explains a significant portion of the variance in these items, indicating strong factor reliability. Items with moderate  $R^2$  values, such as Q2 and Q3 with values of 0.36 and 0.37, respectively, still have a relevant proportion of their variance explained by the model. While not as high as some other items, these values still indicate a good level of construct reliability and suggest that these items contribute valuable information to their respective factors. A range of  $R^2$  values, with the majority on the higher end, generally indicates a model that fits the data well. It shows that the latent factors identified through the CFA are meaningful and significantly explain the variance in the observed variables. However, the variation in  $R^2$  values also highlights the complexity of the measured constructs and suggests that some factors may be more strongly represented by their indicators than others.

Table. Factor Covariances

			<b>Estimate</b>	<b>Std. Error</b>	<b>z-value</b>	<b>p</b>	<b>95% Confidence Interval Lower</b>	<b>95% Confidence Interval Upper</b>	<b>Std. Est. (all)</b>
Factor 1	↔	Factor 2	0.59	0.03	21.96	< .001	0.49	0.68	0.59
Factor 1	↔	Factor 3	0.62	0.03	22.67	< .001	0.52	0.71	0.62
Factor 1	↔	Factor 4	0.39	0.02	19.07	< .001	0.28	0.50	0.39
Factor 2	↔	Factor 3	0.52	0.03	17.84	< .001	0.40	0.62	0.52
Factor 2	↔	Factor 4	0.56	0.02	25.05	< .001	0.45	0.66	0.56
Factor 3	↔	Factor 4	0.38	0.02	15.84	< .001	0.25	0.5	0.38

The factor covariance is significant ( $p < .001$ ), with estimates indicating moderate to strong correlations between factors (ranging from 0.38 to 0.62). This suggests that while factors are distinct, they are not completely independent of each other, reflecting the interconnected nature of different aspects of emotional intelligence by listening/hearing. The correlations between factors, ranging from 0.38 to 0.62, demonstrate moderate to strong relationships. Low and moderate correlations support discriminant validity and can indicate a well-fitting model, especially if these correlations are theoretically justified. They show that while factors are related, they are distinct enough to be considered separate constructs.

The residual variances for most indicators (items) are low and lower than 0.5, suggesting that the model explains a significant portion of each item's variance (Table 2A). This indicates good individual item reliability within the context of the model. Residual variances for Q2, A3, Q6, and Q9 are higher than

Entries in the Table marked as “< .001” indicate residual covariance that is effectively zero or very close to zero, suggesting that the model adequately captures the relationships between these pairs of variables. For instance, the residual covariance between Q1 and all other variables (where not explicitly listed) is practically negligible, implying a good model fit for these variable pairs. However, a higher residual covariance of 0.1 suggests a portion of the relationship between Q1 and Q2 or between Q4 and Q5 that the model does not account for. Both questions (Q1 and Q2) relate to difficulties recognizing and understanding emotions. Q1 refers to people with whom the respondent communicates regularly, which could include men (as mentioned in Q2). If respondents who have difficulty recognizing emotions in regular communications also tend to struggle specifically with understanding emotions expressed by men, this could justify a shared variance. Q4 and Q5 both involve the recognition of emotions in others, with Q4 focusing on people on television and Q5 on young people so that the shared variance might be expected. These items may steer future questionnaire refinements. Nevertheless, these isolated instances are not concerning, especially when combined with model fit indices and metrics.

However, when accounting for residual covariance between Q1 and Q2, between Q2 and Q7, and between Q4 and Q5, we get improved model fit, where all these covariance are statistically significant at a 5% level. RMSEA takes a value of 0.05 with a 90% CI interval [0.04, 0.06], while SRMR is 0.06. Other measures also demonstrate a small increase, with CFI reaching 0.99, TLI of 9.987, and PNFI of 0.777. The goodness of fit is 0.989, which shows that when accounting for these residual covariance's, we get an improved model.

Table. Residual covariance matrix

	Q1	Q2	Q3	Q4	Q5	Q6	Q7	Q8	Q9	Q10	Q11	Q12	Q13	Q14	Q15	Q16
Q1	< .001															
Q2	0.1	< .001														
Q3	0.09	0.01	< .001													
Q4	< .001	< .001	< .001	< .001												
Q5	< .001	< .001	< .001	0.13	< .001											
Q6	3.11 × 10 <sup>-3</sup>	0.03	0.05	< .001	< .001	< .001										

<b>Q7</b>	0.0 1	0.1	3.6 3× 10 <sup>-3</sup>	<.00 1	<.00 1	0.0 7	<.00 1									
<b>Q8</b>	0.0 8	0.0 4	<.00 1	<.00 1	<.00 1	<.00 1	9.8 4× 10 <sup>-3</sup>	<.00 1								
<b>Q9</b>	0.0 2	0.0 9	0.0 3	<.00 1	0.0 6	<.00 1	<.00 1	0.0 6	<.00 1							
<b>Q10</b>	<.00 1	<.00 1	<.00 1	0.1 1	0.0 6	<.00 1	<.00 1	<.00 1	0.1 2	<.00 1						
<b>Q11</b>	<.00 1	<.00 1	<.00 1	0.0 8	0.0 2	<.00 1	0.0 1	<.00 1	0.0 9	<.00 1	<.00 1					
<b>Q12</b>	0.0 7	<.00 1	0.0 5	0.0 4	0.1 4	0.0 5	0.0 6	<.00 1	<.00 1	0.0 9	0.1	<.00 1				
<b>Q13</b>	0.0 5	0.0 5	<.00 1	<.00 1	2.8 5× 10 <sup>-3</sup>	0.0 5	0.0 7	0.0 7	0.0 3	0.0 2	0.0 6	0.0 4	<.00 1			
<b>Q14</b>	<.00 1	<.00 1	<.00 1	<.00 1	<.00 1	3.1 5× 10 <sup>-3</sup>	<.00 1	<.00 1	<.00 1	<.00 1	<.00 1	<.00 1	<.00 1	<.00 1		
<b>Q15</b>	<.00 1	<.00 1	<.00 1	<.00 1	<.00 1	5.2 8× 10 <sup>-3</sup>	<.00 1	7.4 1× 10 <sup>-3</sup>	<.00 1	<.00 1	<.00 1	<.00 1	<.00 1	0.0 7	<.00 1	
<b>Q16</b>	0.0 6	<.00 1	0.0 3	<.00 1	0.0 8	9.1 1× 10 <sup>-3</sup>	<.00 1	<.00 1	<.00 1	<.00 1	<.00 1	<.00 1	<.00 1	0.0 3	0.0 3	<.00 1

The CFA results confirm the hypothesized structure derived from PCA, indicating that the model of emotional intelligence related to listening/hearing is both valid and reliable. The strong factor loadings and fit indices suggest that the identified factors are meaningful and reflect distinct dimensions of emotional intelligence in the context of listening/hearing. The model's strong explanatory power (as evidenced by R<sup>2</sup> values and residual variances) further underscores the relevance of these factors to understanding emotional intelligence nuances. Factor 1 deals with recognizing and understanding the emotions of other people expressed verbally. On the other hand, Factor 2 deals with how respondents perceive other people recognize and understand their emotions. Factor 3 deals with difficulties in recognizing other people's emotions due to environmental challenges. Factor 4 involves recognizing one's own emotions that stem from unsuccessful recognition of other people's emotions.

Figure. Model plot

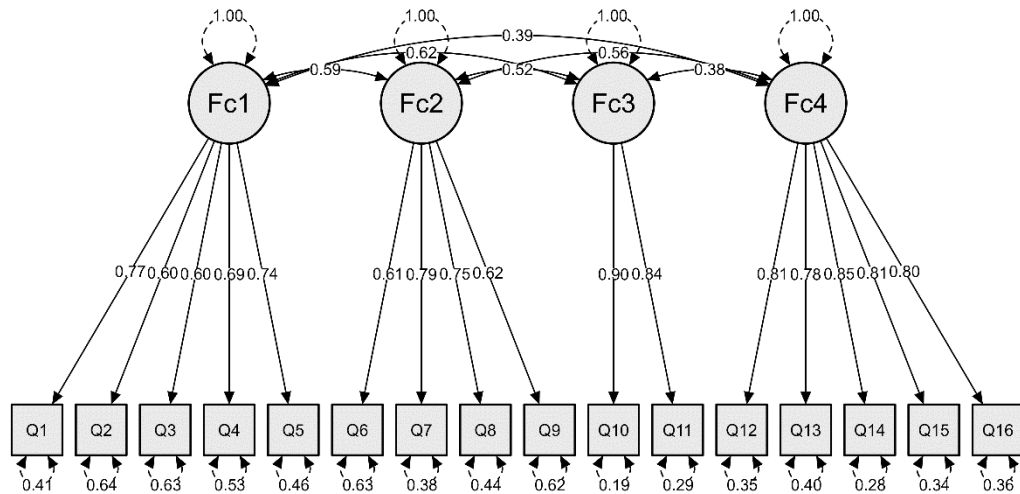

The provided Confirmatory Factor Analysis (CFA) plot represents a four-factor model with observed variables (Q1 to Q16) loading onto their respective latent factors (Fc1 to Fc4). The numbers adjacent to the arrows from the latent factors to the observed variables are the factor loadings, representing the strength and direction of the relationship between each factor and its associated variables. For example, Q1 has a loading of 0.77 on Fc1, indicating a strong positive relationship. The numbers beneath each observed variable (the squares labeled Q1 to Q16) are the residual variances, representing the proportion of variance in the observed variables that is not explained by the latent factors. For instance, Q1 has a residual variance of 0.41, meaning that Fc1 does not account for 41% of its variance. The residual variances range from 0.19 to 0.64, with Q10 showing the lowest residual variance, implying that Fc3 explains a large proportion of its variance.

The curved arrows with numbers between the latent factors represent the correlations between factors, indicating how closely related the factors are. For example, Fc1 and Fc2 correlate 0.59, indicating a moderate positive relationship. The factor correlations range from 0.38 to 0.62, which suggests that while factors are related, they are distinct constructs. It's important to note that these correlations are not so high as to suggest redundancy between the factors.

Overall, the CFA plot suggests a well-fitting model with strong factor loadings, moderate factor correlations, and a range of residual variances, all typical in psychological and social science research. The relationships between the latent factors suggest that they represent related yet distinct constructs, which could align with a theoretical framework where different facets of a broader psychological concept (such as social awareness) are being measured.

Building upon the defined four-factor model elucidated through CFA, which indicates a multidimensional structure of the constructs at hand, we now extend our investigation to a higher-order factor model. This subsequent analysis will explore the notion of 'social awareness' as an overarching construct, hypothesized to be represented by the interrelated yet distinct first-order factors—integrating them into a cohesive framework that captures the essence of social awareness in the context of our study.

#### *4.4. Hierarchical confirmatory factor analysis*

First, we examine how each factor contributes to the broader concept of social awareness, especially in listening and hearing. Factor 1 is directly relevant to social awareness as it encompasses the ability to accurately perceive and interpret the emotions of others through verbal cues. This ability is a core component of social awareness, which involves understanding others' feelings and perspectives. Factor 2 reflects a reflective aspect of social interaction, focusing on the individual's perceptions of how well others understand their emotions. While it's a step removed from the direct act of listening and hearing, it still significantly impacts social awareness by highlighting the reciprocal nature of emotional understanding in social interactions. Factor 3 addresses external challenges to recognizing and interpreting emotions, such as noise or other distractions. Including this factor in the model of social awareness underscores the contextual sensitivity of social awareness skills, emphasizing that effective listening and emotional recognition are contingent upon the environment. While Factor 4 is crucial for self-awareness and emotional regulation, it might be considered tangentially related to the outward-focused processes typically associated with social awareness in listening and hearing contexts.

Using only the first two factors to build a model of social awareness can be justified as they directly pertain to the interpersonal aspects of social awareness—understanding others' emotions and perceiving how others understand one's emotions. These factors capture the essence of social awareness in the context of listening and hearing by focusing on the reciprocal nature of emotional exchanges in social interactions. On the other hand, factors 1 and 3 underscore a model of social awareness that is both interactional and contextual. It emphasizes the dynamic nature of social awareness as it manifests in real-world settings, where environmental factors play a crucial role. This approach might be particularly relevant in applied settings, such as communication training, education, or therapy, where the goal is to enhance practical skills for social interaction and emotional understanding in various contexts. Moreover, factors 2 and 4 highlight a more introspective model of social awareness, focusing on the individual's perceptions and internal emotional landscape as it relates to social interactions. This approach emphasizes the importance of understanding one's position within social exchanges and the reflective processing of emotional experiences. This perspective might be especially relevant in psychological research, counseling, and educational contexts where the goal is to foster deeper self-understanding and emotional regulation skills.

Incorporating all four factors into a comprehensive model of social awareness achieved by listening/hearing offers a holistic perspective that encompasses the multifaceted nature of social awareness. This integrated model combines elements of interpersonal understanding, contextual adaptability, and introspective awareness, as highlighted by the specific contributions of each factor. Therefore, we use all four factors to build a comprehensive version of a model.

The results of the hierarchical confirmatory factor analysis (HCFA) reflect a higher-order factor model in which the four first-order factors are hypothesized to represent the broader construct of social awareness. The factors model shows a significant improvement over the baseline model, with a chi-square value of 289.08 and 100 degrees of freedom, indicating a good fit.

Table. Chi-square test

Model	X <sup>2</sup>	df	p
Baseline model	10828.17	120	
Factor model	245.7	97	< .001

The Comparative Fit Index (CFI), Tucker-Lewis Index (TLI), and other related indices are close to or at 0.98, suggesting an excellent fit to the data. The RMSEA is 0.07, with a lower bound of the 90% CI at 0.06 and an upper bound at 0.08. This is slightly above the ideal cutoff of 0.05 but still within a reasonable range, especially for complex models. The SRMR value is 0.07, which indicates a good model fit as it is below the commonly used cutoff of 0.08. At 0.98, the GFI also indicates a good fit of the model to the data.

Table. Fit indices and metrics

Index	Value
Comparative Fit Index (CFI)	0.986
Tucker-Lewis Index (TLI)	0.983
Bentler-Bonett Non-normed Fit Index (NNFI)	0.983
Bentler-Bonett Normed Fit Index (NFI)	0.977
Parsimony Normed Fit Index (PNFI)	0.79
Bollen's Relative Fit Index (RFI)	0.972
Bollen's Incremental Fit Index (IFI)	0.986
Relative Noncentrality Index (RNI)	0.986
Metric	Value
Root mean square error of approximation (RMSEA)	0.0627
RMSEA 90% CI lower bound	0.053
RMSEA 90% CI upper bound	0.0725
RMSEA p-value	0.017
Standardized root mean square residual (SRMR)	0.063
Hoelter's critical N ( $\alpha = .05$ )	193.05
Hoelter's critical N ( $\alpha = .01$ )	211.01
Goodness of fit index (GFI)	0.986
McDonald fit index (MFI)	0.826

The first-order factor loadings range from 0.34 to 0.68 for the individual items, indicating that all items have a substantial loading on their respective factors. Thus, each factor is well-defined by its indicators. The first-order factor loadings ( $\lambda$ ), though lower than the often-cited threshold of 0.7, are substantial and statistically significant ( $p < .001$ ), indicating that all items contribute meaningfully to their respective factors. These loadings demonstrate that the observed variables are relevant indicators of the latent constructs they are intended to measure, albeit with varying degrees of strength. Even the lowest loading (Q2 on Factor 1) is meaningful, suggesting that difficulties understanding emotions expressed by men (as captured by Q2) are part of the broader construct related to recognizing and understanding emotions expressed verbally. The



lower loading implies that this aspect is slightly less central to the construct than others but still relevant. Higher loadings, such as Q10's on Factor 3, indicate strong relationships between these items and their factors. Q10's loading suggests that environmental challenges significantly impact the ability to recognize others' emotions, a critical aspect of social awareness in listening and hearing. These factors, combined with the significance of the loadings ( $p < .001$ ), suggest that the items are meaningful indicators of their respective factors and that the model is a good fit for the data.

The second-order loadings ( $\gamma$ ), which indicate the relationship between the first-order factors and the higher-order factor of social awareness, range from 0.74 to 1.48. These loadings are large and statistically significant, suggesting that the first-order factors strongly indicate the higher-order construct.

Table. Factor loadings

Factor	Indicator	Symbol	Estimate	Std. Error	z-value	p	95% Confidence Interval Lower	95% Confidence Interval Upper	Std. Est. (all)	R <sup>2</sup>
Factor 1	Q1	$\lambda_{11}$	0.46	0.03	17.69	< .001	0.33	0.59	0.75	0.56
	Q2	$\lambda_{12}$	0.34	0.02	16.68	< .001	0.25	0.47	0.55	0.3
	Q3	$\lambda_{13}$	0.39	0.02	16.87	< .001	0.28	0.48	0.62	0.39
	Q4	$\lambda_{14}$	0.38	0.03	17.55	< .001	0.28	0.46	0.6	0.37
	Q5	$\lambda_{15}$	0.42	0.03	17.79	< .001	0.3	0.51	0.67	0.45
Factor 2	Q6	$\lambda_{21}$	0.34	0.03	11.40	< .001	0.21	0.44	0.61	0.37
	Q7	$\lambda_{22}$	0.44	0.04	11.94	< .001	0.27	0.55	0.78	0.6
	Q8	$\lambda_{23}$	0.43	0.03	12.10	< .001	0.24	0.54	0.75	0.57
	Q9	$\lambda_{24}$	0.35	0.03	11.47	< .001	0.22	0.45	0.63	0.39
Factor 3	Q10	$\lambda_{31}$	0.64	0.03	19.68	< .001	0.53	0.76	0.90	0.81
	Q11	$\lambda_{32}$	0.60	0.03	20.82	< .001	0.5	0.71	0.85	0.72
Factor 4	Q12	$\lambda_{41}$	0.65	0.02	30.91	< .001	0.57	0.72	0.81	0.66
	Q13	$\lambda_{42}$	0.62	0.02	30.75	< .001	0.55	0.69	0.78	0.6

	Q14	$\lambda_{43}$	0.68	0.02	33.70	< .001	0.59	0.75	0.85	0.72
	Q15	$\lambda_{44}$	0.65	0.02	32.77	< .001	0.55	0.72	0.81	0.65
	Q16	$\lambda_{45}$	0.64	0.02	31.60	< .001	0.55	0.72	0.80	0.64
Second Order	Factor 1	$\gamma_{11}$	1.26	0.11	11.2	< .001	0.91	1.90	0.78	0.61
	Factor 2	$\gamma_{12}$	1.46	0.15	9.91	< .001	1.04	2.68	0.83	0.68
	Factor 3	$\gamma_{13}$	0.99	0.07	14.89	< .001	0.73	1.31	0.70	0.50
	Factor 4	$\gamma_{14}$	0.74	0.04	21.02	< .001	0.56	1	0.6	0.36

*Note.* Not all bootstrap samples were successful: CI based on 950 samples.

The  $R^2$  values for the first-order factor loadings indicate the proportion of variance in each item explained by its respective factor, ranging from 0.36 to 0.81. This suggests good explanatory power for most items. For the second-order loadings,  $R^2$  values range from 0.35 to 0.69, indicating that the higher-order factor of social awareness explains a substantial portion of the variance in the first-order factors.

While some second-order items (factors) have loadings higher than 1, they are not inherently problematic in a higher-order model (Jöreskog, 2014, Deegan Jr, 1978). As explained by Jöreskog, in the context of SEM and particularly with higher-order factor models, standardized coefficients—including factor loadings—can exceed 1. This phenomenon reflects strong relationships between the higher-order construct and its underlying factors rather than indicating a flaw in the model. These findings suggest that the higher-order factor strongly influences the first-order factors. Such a scenario is plausible in constructs where the higher-order factor is conceptualized to have a potent, encompassing impact on its subdimensions.

The second-order loadings indicate a strong relationship between the first-order factors and the overarching construct of social awareness. Notably, some loadings exceed 1, which, as discussed, reflects a strong influence of the higher-order construct on its subdimensions and is not inherently problematic. A loading greater than 1, such as Factor 2's, suggests that perceptions of how others understand one's emotions (Factor 2) are a potent component of social awareness. This might indicate that the reciprocal understanding of emotions is a key aspect of social interactions and awareness. The significant loadings across all first-order factors to the higher-order factor of social awareness underscore that social awareness achieved by listening/hearing, is a multifaceted construct that encompasses recognizing and understanding emotions in oneself and others, navigating environmental challenges, and perceiving reciprocal emotional understanding. The HCFA results support the viability of a higher-order structure with social awareness as a comprehensive construct derived from the four first-order factors. The good fit indices and strong factor loadings, along with the substantial explanatory power of the second-order factor, affirm the conceptualization of social awareness as encompassing the various dimensions of emotional intelligence by listening/hearing represented by the first-order factors.

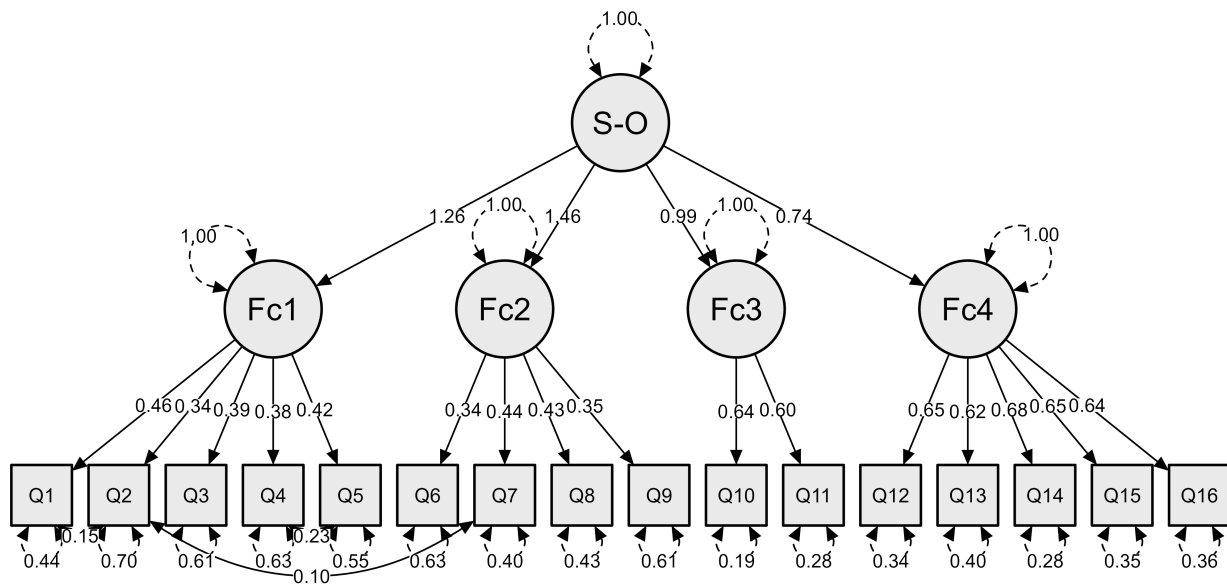

## 5. DISCUSSION

In discussing a comprehensive model of social awareness achieved by listening/hearing, it is crucial to articulate how each factor contributes to social awareness, identify potential gaps, and explore its relevance for decision-making and organizational dynamics.

Emotional Intelligence (EI) is the ability to recognize, understand, manage, and use one's emotions and those of others effectively. It encompasses several key components: self-awareness, self-regulation, motivation, empathy (or social awareness), and social skills. These components influence how individuals perceive and navigate their social environment, making EI integral to decision-making processes. Emotions provide valuable information that can influence the perception of options and outcomes in decision-making. EI facilitates the accurate interpretation and constructive use of this emotional information. High EI individuals are better at managing stress and emotional upheaval, allowing for clearer thinking and more rational decision-making under pressure. Decision-making is important because it often involves or impacts others. EI, through empathy and social skills, aids in predicting and understanding others' reactions, fostering collaborative decisions that consider multiple perspectives. EI contributes to resolving conflicts by understanding emotional underpinnings, which is essential for making decisions requiring consensus or collaboration.

Social Awareness, a core component of EI, particularly achieved through listening/hearing, directly impacts decision-making by enhancing the understanding of social cues, emotional states, and needs of others. This understanding is crucial in interactive environments where decisions are not made in isolation but in the context of interpersonal relationships and dynamics. By accurately perceiving and interpreting others' emotions, individuals can make more informed decisions that account for the likely reactions and preferences of others. Effective listening and hearing facilitate clearer communication, reducing misunderstandings and enabling more effective negotiation and persuasion in decision-making processes. For leaders, social awareness allows for empathetic leadership, which not only improves morale but also informs decisions that are more aligned with the collective goals and values of the group.

Each factor within the model of social awareness contributes distinctly to decision-making processes. Factor 1, which involves recognizing and understanding others' emotions, offers insights into emotional responses, facilitating decisions that gain wider acceptance and support. Factor 2 focuses on the perceived emotional understanding by others, shaping the way decisions are communicated and perceived to ensure they are empathetically aligned with others' interpretations, which promotes trust and cooperation. Factor 3's emphasis on navigating environmental challenges bolsters decision-making adaptability by considering external influences on emotional interpretation and communication, ensuring decisions fit the situational context. Lastly, Factor 4 underscores the importance of self-awareness of emotional responses, aiding in reflective decision-making by mitigating emotional biases and fostering more objective and balanced outcomes. Together, these factors enrich decision-making by integrating emotional intelligence and social awareness, leading to decisions that are informed and considerate of the social and environmental context. Yip and Fisher's analysis shows that identifying a listening paradox—where listening is beneficial for speakers but costly for listeners—complements your findings on the emotional and cognitive demands of listening from the perspective of EI. (Yip & Fisher, 2022) Research on the hierarchical model of social awareness, which incorporates the challenges of listening in noisy environments or when deciphering emotions from spoken language, provides empirical insights into managing the tensions between organizational goals and the listener's experience as outlined by Yip and Fisher. Our research also confirms this feature, where interpreting other people's emotions in noisy situations or when multiple conversations occur causes difficulties. Neill and Bowen's (Neill & Bowen, 2021) study sheds light on practical implications for overcoming listening barriers and leveraging technology to maintain a connection with employees, particularly relevant to our research on EI in listening. The challenges of remote work and the increased reliance on digital communication platforms underscore the need for innovative approaches to preserve listening effectiveness as a component of EI and social awareness in organizations. These are aspects that should be carefully processed in future research that builds on the presented research. Alzoubi and Aziz (2021) emphasize the positive relationship between EI managers and the quality of their strategic decisions. Emphasizing the role of listening and social awareness, our research provides actionable insights for leaders and managers to develop these specific EI skills to improve their decision-making abilities. It is about recommendations for strategic management perspectives in organizations and possible interventions, primarily through education, creating a learning environment in which the aforementioned expected dimensions are practiced.

EI, through its social awareness component achieved by listening/hearing, plays a pivotal role in decision-making, especially in interactive environments. Each factor of social awareness contributes uniquely to the decision-making process, enabling individuals to leverage emotional and social information effectively. This results in decisions that are more informed and rational and more empathetic and adaptive to the social context, enhancing interpersonal relations and facilitating successful outcomes in both personal and organizational settings.

If we summarized the potential for intervention:

- *enhanced communication*: by fostering an understanding of and empathy for others' emotions, the model supports more effective communication, a cornerstone of successful teamwork and leadership within organizations.

- *conflict resolution*: The model's emphasis on mutual understanding and self-awareness can facilitate conflict resolution strategies sensitive to individuals' feelings and perspectives, promoting a more harmonious organizational climate.
- *Adaptive leadership*: As highlighted in factor 3, recognizing environmental challenges and adapting to them is essential for leaders who must navigate the complexities of organizational life and steer their teams through change.
- *Employee engagement and satisfaction*: According to the described model, a work environment that values and cultivates social awareness can enhance employee engagement and satisfaction by creating a sense of being understood and valued.

De Smet et al. (2021) outline the transition to hybrid work models as a response to the COVID-19 pandemic and highlight the importance of reimagining work in the context of increased uncertainty. Our research directly contributes to this conversation by offering a deeper understanding of how leaders can effectively manage teams in a hybrid setting. Leaders who excel in listening and social awareness are better equipped to navigate the complexities of hybrid work environments, ensuring that employees feel heard, understood, and connected, regardless of their physical location. The challenges of remote work, such as fatigue, difficulty disconnecting, and a weakening sense of belonging, are highlighted in the article. Our research underscores EI's role in combatting these challenges by fostering a supportive and empathetic workplace culture. Leaders skilled in listening and social awareness can better identify signs of employee burnout, facilitate meaningful connections, and implement strategies that support well-being and engagement, which is crucial in a hybrid work model. As companies experiment with hybrid models, effective communication and collaboration become paramount. This contributes to developing collaboration tools and meeting norms that accommodate the needs of a diverse workforce. Finally, by focusing on social awareness achieved through active listening, we propose a practical pathway for leaders to enhance their decision-making effectiveness within complex systems and complement (Hallo et al., 2020) findings. The Paluta study (Harahap & Ali, 2020) states that decision-making is a significant mediator in the relationship between EI and managerial performance. Our research underscores the critical role of social awareness in this process, suggesting that the ability to listen and interpret social cues effectively can lead to more informed and empathetic decision-making, thereby improving managerial outcomes.

## **6. CONCLUSION**

With its multidimensional approach, the derived model of social awareness offers significant insights into enhancing interpersonal relationships and organizational effectiveness. We highlight the model's theoretical and practical contributions by outlining how each factor contributes to a nuanced understanding of social awareness, acknowledging the model's limitations, and exploring its implications for decision-making and organizational dynamics. This comprehensive view advances academic discourse on social awareness and provides actionable strategies for fostering more empathetic, adaptable, and cohesive organizational environments.

### *6.1. Theoretical implications*

The theoretical implications extend beyond the empirical findings, offering significant contributions to the existing body of knowledge in organizational behavior. Firstly, the study underscores the multidimensionality of EI, particularly highlighting the critical roles of recognizing and understanding emotions through auditory cues. This emphasis on the auditory aspects of EI challenges and complements existing models predominantly focused on visual cues, suggesting a broader, more inclusive approach to understanding emotional cues.

Secondly, by delineating specific factors contributing to social awareness within the auditory domain, the research provides a nuanced framework that bridges individual cognitive processes and interpersonal dynamics. This framework suggests that effective EI involves a complex interplay between internal self-awareness and external social perception, particularly in listening and hearing. Furthermore, the study's findings on the variability of EI competencies among individuals point to the potential for personalized interventions to enhance specific aspects of EI.

Next, by identifying areas less covered by existing models, such as the impact of environmental challenges on emotional recognition and the importance of perceived emotional understanding, this study opens new avenues for research into how environmental and perceptual factors influence EI. These theoretical implications enrich the discourse on emotional intelligence, offering a more comprehensive understanding of its components and their impact on social interactions and organizational dynamics.

Extending these theoretical implications into business decision-making presents a nuanced understanding of how emotional intelligence (EI), particularly through listening and hearing, can profoundly influence organizational strategies and outcomes. As highlighted in this study, recognizing and understanding emotions through auditory cues can significantly impact leadership effectiveness, negotiation strategies, and customer relations by enabling a more empathetic and nuanced approach to stakeholder interactions. The emphasis on the auditory dimension of EI challenges traditional paradigms that focus on visual cues, proposing that auditory-based emotional cues are equally crucial in guiding business decisions that are sensitive to the emotional states of others.

The delineation of specific factors contributing to social awareness in the auditory domain underscores the importance of cultivating a workplace environment that values and enhances EI competencies. This could lead to more effective team collaborations and conflict resolution strategies, as individuals become adept at navigating the complex emotional underpinnings of their interactions. Furthermore, the identification of variability in EI competencies among individuals suggests a personalized approach to professional development, where employees are supported in strengthening their EI skills in alignment with their specific needs and roles within the organization.

Moreover, the acknowledgment of environmental and perceptual factors in influencing emotional recognition provides a basis for rethinking office design, communication channels, and team dynamics to optimize emotional clarity and understanding. This insight can create more inclusive and emotionally intelligent business cultures, promoting a sense of belonging and understanding that enhances overall organizational performance.

In essence, the theoretical implications of this study illuminate the profound role of EI in business decision-making. By fostering an organizational culture that prioritizes the development and application of EI competencies, particularly those related to listening and hearing, businesses can achieve a competitive edge in understanding and meeting the emotional and psychological needs of their employees, customers, and stakeholders, leading to decisions that are not only strategically sound but also emotionally intelligent.

### *6.2. Practical implications*

The practical implications of this study on emotional intelligence (EI) related to listening and hearing are manifold and significant for organizational practices and personal development strategies. Identifying specific factors influencing EI in auditory communication highlights the importance of developing targeted training programs that enhance listening skills, empathy, and the ability to interpret emotional cues accurately.

For organizations, this suggests the potential for designing workshops and interventions focused on improving team communication, conflict resolution, and leadership effectiveness by fostering a deeper understanding of the emotional landscape within professional interactions. The study also points to the need for creating supportive environments that minimize auditory distractions, facilitating clearer emotional communication and understanding.

On a personal level, the findings encourage individuals to cultivate a heightened awareness of their own and others' emotional expressions through active listening, potentially improving personal relationships and social connectivity. Moreover, the emphasis on the variability of EI competencies suggests a personalized approach to EI development, where individuals can identify and strengthen specific areas of need. Finally, the acknowledgment of environmental and perceptual factors in emotional recognition opens up discussions on the design of inclusive and emotionally intelligent workplaces that cater to diverse needs and preferences, ultimately enhancing employee well-being and organizational performance.

### *6.3. Limitations*

The study comprehensively explores emotional intelligence (EI) related to listening and hearing, yet several limitations require consideration. First, the model primarily focuses on verbal aspects of emotional intelligence, potentially underrepresenting the role of non-verbal cues, such as body language and facial expressions, in fully understanding others' emotions. This oversight might limit the model's applicability in contexts where non-verbal communication is paramount. However, this model may still be applicable in a business setting due to a high share of verbal communication. Moreover, a relevant part of business communication is written, and since it is not included in this study, it should be considered a possible research direction.

Additionally, the study's scope might not fully capture the intricacies of cultural sensitivity, as the study has been conducted in Croatia only. Emotional expression and interpretation can vary significantly across cultures, and the model's emphasis on listening and hearing may not adequately account for these nuances, possibly affecting its effectiveness in global or multicultural settings.

Furthermore, the study's findings, particularly from the confirmatory factor analysis (CFA) and hierarchical model exploration, suggest a robust theoretical framework and highlight the complexity of measuring and interpreting emotional intelligence through listening and hearing.

The significant model fit indices and factor loadings underscore the identified factors' relevance to social awareness yet also point to the challenges of quantifying such a multifaceted construct.

While it is not uncommon to use convenience samples in social studies, this represents a serious limitation. While we gain interesting insights and reveal paths for future exploration, none of the findings are generalizable to a population. Confirming these results requires an investigation based on a probabilistic sample in future studies.

Lastly, while the study advances understanding and provides a foundation for developing targeted interventions to enhance emotional intelligence and business environment, the identified limitations underscore the need for ongoing research. Future studies should address these gaps by incorporating a broader range of emotional intelligence components, exploring the impact of cultural and non-verbal communication factors, and employing diverse methodological approaches to deepen the insight into how emotional intelligence influences and is influenced by listening and hearing in various contexts.

#### *6.4. Future research*

Today, organizations with unstable, changing working conditions are under increased pressure from the new workforce generation (Generation Z, very soon from Generation Alpha also) and new changed working conditions, especially under the influence of the development of technology and artificial intelligence as well as new environmental values, put new pressure on organizations. In the future, organizations need new insights into strategic management and ways of making "better" and more acceptable decisions. One aspect has been discussed, but many questions remain open, such as models and intervention methods in creating social awareness of employees, an empathetic work environment, ways of selecting leaders in organizations (for example, preferring EI over productivity), objective measures and diverse samples. Also, research has to be done on cultural or structural barriers that may prevent the effective implementation of an emotional listening strategy.

#### **LITERATURE:**

1. Aamir, A. (2023). Emotional Intelligence and Organizational Commitment-Application of the Goleman's Model of Emotional Intelligence. *International Journal of Intellectual Human Resource Management (IJHRM)*, 4(01), 01–06.
2. Abu-Shanab, E. A., & Shanab, A. A. (2022). The influence of emotional intelligence on technology adoption and decision-making process. *International Journal of Applied Decision Sciences*, 15(5), 604-622.
3. Ahsan, M. J. (2023). The role of emotional intelligence in effective corporate social responsibility leadership. *International Journal of Organizational Analysis*, 31(8), 75–91.
4. Alsalminy, B. M. K., & Omrane, A. (2023). The effects of emotional intelligence on leadership effectiveness (A prospective case study of three industrial companies in Iraq). *Journal of Positive Psychology and Wellbeing*, 988–1006.
5. Alzoubi, H. M., & Aziz, R. (2021). Does emotional intelligence contribute to quality of strategic decisions? The mediating role of open innovation. *Journal of Open Innovation: Technology, Market, and Complexity*, 7(2), 130.



- 5.1. Baloul, M. S., Rivera, M., Yeh, V. J., Lund, S., Piltin, M., Farley, D., & D'Angelo, J. D. (2024). Emotional intelligence and LEGO-based communication assessments as indicators of peer evaluations. *Surgery*, 176(4), 1079–1082. <https://doi.org/10.1016/j.surg.2024.06.038>
6. Bletscher, C. G., & Lee, S. (2021). The impact of active empathetic listening on an introductory communication course. *College Teaching*, 69(3), 161-168.
7. Bru-Luna, L. M., Martí-Vilar, M., Merino-Soto, C., & Cervera-Santiago, J. L. (2021). Emotional intelligence measures: A systematic review. *Healthcare*, 9(12), 1696.
8. Burcea, Ş. G., & Sabie, O. M. (2020). Is emotional intelligence a determinant factor for leader's skills development? Essential literature perspectives. *Management and Economics Review*, 5(1), 68–77.
9. Buşu, A.-F. (2020). Emotional intelligence as a type of cognitive ability. *Revista de Ştiinţe Politice. Revue Des Sciences Politiques*, 66, 204–215.
10. Camplisson, C., & Cormican, K. (2023). Analysis of emotional intelligence in project managers: Scale development and validation. *Procedia Computer Science*, 219, 1777–1784.
11. Chagelishvili, A. (2023). The contribution of emotional intelligence to human resource development and career success: A review.
12. Chaidi, I., & Drigas, A. (2022). Emotional intelligence and learning, and the role of ICTs. *Technium Soc. Sci. J.*, 35, 56.
13. De Smet, A., Dowling, B., Mysore, M., & Reich, A. (2021). It's time for leaders to get real about hybrid. *The McKinsey Quarterly*, 1–10.
14. Deegan Jr, J. (1978). On the occurrence of standardized regression coefficients greater than one. *Educational and Psychological Measurement*, 38(4), 873–888.
15. Drigas, A., & Papoutsis, C. (2021). Nine Layer Pyramid Model Questionnaire for Emotional Intelligence. *International Journal of Online & Biomedical Engineering*, 17(7).
16. Elena, S., Elena, K., & Ekaterina, O. (2020). Development of an objective methodology for measurement of emotional intelligence. Emotional intelligence and socio-demographics of employees in Russian organizations. *Организационная Психология*, 10(1), 45–61.
17. Epskamp, S. (2015). semPlot: Unified visualizations of structural equation models. *Structural Equation Modeling: A Multidisciplinary Journal*, 22(3), 474–483.
18. Epskamp, S., Costantini, G., Haslbeck, J., Cramer, A. O., Epskamp, M. S., & RSVGTipsDevice, S. (2017). Package 'qgraph.' Citeseer.
19. FEDOROVA, Y., PILKOVÁ, A., MIKUŠ, J., & HOLIENKA, M. (2023). EMOTIONAL INTELLIGENCE TRAINING TOOLS FOR BUSINESS. 7th FEB International Scientific Conference, 435.
20. Fernandez, A., Kullu, F. D., & Shankar, R. (2020). A Grounded Research Approach to Sustainable Leadership Practices and Competencies. *Sustainable Human Resource Management: Transforming Organizations, Societies and Environment*, 71–86.

21. Ghasemahmad, Z., Mrvelj, A., Panditi, R., Sharma, B., Perumal, K. D., & Wenstrup, J. J. (2024). Emotional vocalizations alter behaviors and neurochemical release into the amygdala. *Elife*, 12, RP88838.
22. Goleman, D. (1995). *Emotional intelligence*. Jakarta: Gramedia Utama.
23. Goleman, D. (1998). *Working with emotional intelligence*. Bantam.
24. Goleman, D. (2021). *Leadership: The power of emotional intelligence*. More Than Sound LLC.
25. Görgens-Ekermans, G., & Roux, C. (2021). Revisiting the emotional intelligence and transformational leadership debate:(How) does emotional intelligence matter to effective leadership? *SA Journal of Human Resource Management*, 19, 1279.
26. Hallo, L., Nguyen, T., Gorod, A., & Tran, P. (2020). Effectiveness of leadership decision-making in complex systems. *Systems*, 8(1), 5.
27. Harahap, E. H., & Ali, H. (2020). Managerial performance model through decision making and emotional intelligence in Paluta district. *Dinasti International Journal of Economics, Finance & Accounting*, 1(2), 264–274.
28. Hayton, J. C., Allen, D. G., & Scarpello, V. (2004). Factor retention decisions in exploratory factor analysis: A tutorial on parallel analysis. *Organizational Research Methods*, 7(2), 191–205.
29. Heavin, H., & Keet, M. (2020). Client-Centered Communication: How Effective Lawyering Requires Emotional Intelligence, Active Listening, and Client Choice. *Cardozo J. Conflict Resol.*, 22, 199.
30. Hlaing, M. S., & Fernando, M. S. C. (2021). Designing a prototype coaching model based on emotional intelligence and job performance: A case study of global technology group company, Myanmar. *ABAC ODI Journal Vision. Action. Outcome*, 8(2), 1–16.
31. Jacobson, A. (2021). *Emotional intelligence: A simple and actionable guide to increasing performance, engagement and ownership*. John Wiley & Sons.
32. James, G., Witten, D., Hastie, T., & Tibshirani, R. (2013). *An introduction to statistical learning* (Vol. 112). Springer.
33. JASP Team. (2023). *JASP (Version 0.16.4)* [Computer software]. <https://jasp-stats.org>
34. Johennesse, L., & Pressley, G. (2023). The Influence of Emotional Intelligence in The Workplace Environment: A Literature Review. *Indonesian Journal of Business, Accounting and Management*, 6(01), 20–23.
35. Jöreskog, K. G. (2014). How large can a standardized coefficient be? 1999.
36. Kargeti, H. (2023). The role of emotional intelligence in building effective workplace: a quantitative study. *Journal of Cardiovascular Disease Research*, 12(4), 2558-2565.
37. Kaur, N., & Hirudayaraj, M. (2021). The role of leader emotional intelligence in organizational learning: A literature review using 4I framework. *New Horizons in Adult Education and Human Resource Development*, 33(1), 51–68.

38. Kaur, R. (2024). Emotional Intelligence at the Workplace: The Untapped Edge for Success. In *Leveraging AI and Emotional Intelligence in Contemporary Business Organizations* (pp. 60–73). IGI Global.
39. Kapoor Sharma, S. & Kumar Mishra, A. (2022). Examining the role of Emotional Intelligence as a mediator for the impact of Virtual Communication on decision making effectiveness during the covid-19 crisis. *Ymer*, 21(3), 473–486.
40. Karpov, A. & Sidorova, N. (2021). Emotional intelligence as a determinant of management decision-making styles. *Perspectives of Science and Education*. 51. 344-359.
41. Khalisah, N. (2023). The Role of Emotional Intelligence in Effective Decision-Making. *Journal of Management and Administration Provision*, 3(1), 17-21.
42. King, D. (2010). Learning by listening: Emotional reflexivity and organizational change in childcare. In *Emotionalizing organizations and organizing emotions* (pp. 230-250). London: Palgrave Macmillan UK.
43. Kour, K., & Ansari, S. A. (2024). The Role of Emotional Intelligence in Leadership Effectiveness and Organisational Behavior. *Revista de Gestão Social e Ambiental*, 18(2), e06885-e06885.
44. Kranefeld, I., Nill, C., & Blickle, G. (2021). Emotion recognition ability for voices, auditory intelligence, general mental ability, and extrinsic career success. *Personality and Individual Differences*, 172, 110587.
45. Krén, H., & Séllei, B. (2021). The role of emotional intelligence in organizational performance. *Periodica Polytechnica Social and Management Sciences*, 29(1), 1–9.
46. Lane, R. D., & Smith, R. (2021). Levels of emotional awareness: Theory and measurement of a socio-emotional skill. *Journal of Intelligence*, 9(3), 42.
47. Lubbadah, T. (2020). Emotional intelligence and leadership—the dark and bright sides. *Modern Management Review*, XXV, 27, 39–50.
48. Marques, J., Dhiman, S., & King, R. (2011). Empathetic listening as a management tool. *Business Renaissance Quarterly*, 6(1), 15.
49. Mayer, J. D. (2002). MSCEIT: Mayer-Salovey-Caruso emotional intelligence test. Toronto, Canada: Multi-Health Systems.
50. Mayer, J. D., Salovey, P., Caruso, D. R., & Cherkasskiy, L. (2011). Emotional intelligence.
51. Moon, J. (2021). Effect of Emotional Intelligence and Leadership Styles on Risk Intelligent Decision Making and Risk Management. *Journal of Engineering, Project & Production Management*, 11(1).
52. Neill, M. S., & Bowen, S. A. (2021). Ethical listening to employees during a pandemic: New approaches, barriers and lessons. *Journal of Communication Management*, 25(3), 276–297.

53. Nils, F. & Rimé, B. (2012). Beyond the myth of venting: Social sharing modes determine the benefits of emotional disclosure. *European Journal of Social Psychology*, 42 (6) 672-681
54. Osborne, J. W., Costello, A. B., & Kellow, J. T. (2008). Exploratory factor analysis (EFA) is rightly described as both an art and a science, where researchers follow a series of analytic steps involving judgments more reminiscent of qualitative inquiry, an interesting irony given the mathematical sophistication underlying EFA models'. *Best Practices in Quantitative Methods*, 86.
55. Paulmann, S., & Kotz, S. A. (2018). The electrophysiology and time course of processing vocal emotion expressions. *The Oxford handbook of voice perception*, 459.
56. Pîrvu, C. (2020). Emotional intelligence—A catalyst for sustainability in modern business. *Theoretical and Empirical Researches in Urban Management*, 15(4), 60–69.
57. R Core Team. (2018a). Package stats. The R Stats Package.
58. R Core Team. (2018b). R: A Language and Environment for Statistical Computing [Computer software]. R Foundation for Statistical Computing. <https://www.r-project.org/>
59. Rechberg, I. D. (2020). Emotional intelligence and knowledge management: A necessary link? *Knowledge and Process Management*, 27(1), 15–24.
60. Reynolds-Kueny, C., & Shoss, M. K. (2021). Sensemaking and negative emotion sharing: Perceived listener reactions as interpersonal cues driving workplace outcomes. *Journal of Business and Psychology*, 36(3), 461-478.
61. Revelle, W., & Revelle, M. W. (2015). Package 'psych.' The Comprehensive R Archive Network, 337(338).
62. Rosseel, Y. (2012). lavaan: An R package for structural equation modeling. *Journal of Statistical Software*, 48, 1–36.
63. Salovey, P., Mayer, J. D., Caruso, D., & Lopes, P. N. (2003). Measuring emotional intelligence as a set of abilities with the Mayer-Salovey-Caruso Emotional Intelligence Test.
64. Saris, W. E., Satorra, A., & Van der Veld, W. M. (2009). Testing structural equation models or detection of misspecifications? *Structural Equation Modeling*, 16(4), 561–582.
65. Sasseti, S. (2021). Unveiling the connection between emotional intelligence and entrepreneurship. In *Entrepreneurship and Emotions: Insights on Venture Performance* (pp. 15–27). Emerald Publishing Limited.
66. Sergey, B., Boris, K., & Nadiia, R. (2020). Modeling of empathy, emotional intelligence and transformational leadership to the project success. *Mathematical Modeling and Simulation of Systems: Selected Papers of 14th International Scientific-Practical Conference, MODS, 2019 June 24-26, Chernihiv, Ukraine*, 209–222.
67. Sfetcu, N. (2020). Emotions and emotional intelligence in organizations. MultiMedia Publishing.
68. Shaffer, G. L. (2020). Social Awareness. In *Emotional Intelligence and Critical Thinking for Library Leaders* (pp. 29–41). Emerald Publishing Limited.

69. Sharma, P., Dhanta, R., & Sharma, A. (2024). Emotional Intelligence and Conflict Resolution in the Workplace. In *Leveraging AI and Emotional Intelligence in Contemporary Business Organizations* (pp. 102–121). IGI Global.
70. Sharma, R., Dhanta, R., & Solomon, D. D. (2023). The Role of Emotional Intelligence in Effective Leadership and Decision-Making in Business Management. In *AI and Emotional Intelligence for Modern Business Management* (pp. 98-112). IGI Global.
71. Singh, G., Liskovoi, L., Launer, S., & Russo, F. (2019). The emotional communication in hearing questionnaire (EMO-CHeQ): Development and evaluation. *Ear and Hearing*, 40(2), 260-271.
72. Shlens, J. (2014). A tutorial on principal component analysis. arXiv Preprint arXiv:1404.1100.
73. Smith, M., Van Oosten, E., & Boyatzis, R. E. (2020). The best managers balance analytical and emotional intelligence. *Harvard Business Review*.
74. Thompson, C. L., Kuah, A. T., Foong, R., & Ng, E. S. (2020). The development of emotional intelligence, self-efficacy, and locus of control in Master of Business Administration students. *Human Resource Development Quarterly*, 31(1), 113–131.
75. Tourangeau, M. (2015). Transformational leadership and prosody: The melody of speech. *Insight*, 11(1), 1–12.
76. Ugoani, J. (2020). Salovey-Mayer Emotional Intelligence Model for Dealing with Problems in Procurement Management. *American Journal of Marketing Research*, 6(3), 28–36.
77. Ugoani, J. (2023). Emotional Intelligence and Success in Tasking Situations. Rhema University/SPGS/23/010.
78. Vrontis, D., Chaarani, H. E., Nemar, S. E., & Dib, H. (2021). The relationship between managers' emotional intelligence and employees' performance. *Journal for International Business and Entrepreneurship Development*, 13(2), 177–196.
79. Wickham, H., Chang, W., & Wickham, M. H. (2016). Package 'ggplot2.' Create Elegant Data Visualisations Using the Grammar of Graphics. Version, 2(1), 1–189.
80. Wickham, H., & Wickham, M. H. (2022). Package 'reshape.' URL: [https://Cran.Rproject.Org/Web/Packages/Reshape2/Reshape2.Pdf](https://cran.rproject.org/web/packages/reshape2/reshape2.pdf) (Дата Звернення: 19.09. 2020).
81. Williams, Z. (2021). Daniel Goleman's Emotionally Intelligent Contribution to Organizational Theory. *Journal of Management and Innovation*, 7(1).
82. Yaşar, E., Tür, E., & Öztürk, İ. (2023). Examining the relationship between social intelligence and social-emotional expertise: The example of hotel management employees. *Scientific Collection «InterConf+»*, 30 (143), 41–51.
83. Yip, J., & Fisher, C. M. (2022). Listening in organizations: A synthesis and future agenda. *Academy of Management Annals*, 16(2), 657–679.

## Appendix

Table 1A. Questionnaire items

Q1	I have difficulties recognizing the emotions expressed by people I communicate with regularly.
Q2	I have difficulties understanding the emotions that men express verbally.
Q3	I have difficulties understanding the emotions that women express verbally.
Q4	It's hard for me to recognize the emotions of people speaking on television.
Q5	I have difficulties understanding the emotions that young people express verbally.
Q6	I believe people misinterpret my emotions (e.g., others think I am angry when I am not).
Q7	I find it difficult to control how my emotions are reflected in my speech.
Q8	I have difficulties conveying my emotions about a topic subtly using my tone of voice.
Q9	I find it difficult to express my emotions about a topic using a tone of voice.
Q10	It's harder for me to recognize the emotions expressed by others when I am surrounded by noise.
Q11	I find it difficult to recognize the emotions expressed by others when someone else is speaking at the same time.
Q12	Because of difficulties in recognizing emotions in speech, I feel left out when I am in a group.
Q13	Difficulties in recognizing emotions expressed verbally cause discomfort when I talk with friends.
Q14	Because of difficulties in recognizing emotions expressed verbally, I feel sad.
Q15	Because of difficulties in recognizing emotions expressed verbally, I feel frustrated.
Q16	My difficulties in verbalizing emotions negatively affect my relationships with friends and family.

Table 2A. Residual variances

Indicator	The first CFA model	The second CFA model
Q1	0.407	0.4443
Q2	0.643	0.704
Q3	0.6341	0.6189
Q4	0.5296	0.6228
Q5	0.457	0.5498
Q6	0.6316	0.6276
Q7	0.3794	0.3924
Q8	0.4369	0.4302
Q9	0.6178	0.6147
Q10	0.1895	0.1898
Q11	0.2868	0.2866
Q12	0.3474	0.3478
Q13	0.3975	0.3973
Q14	0.2792	0.2793
Q15	0.345	0.3448
Q16	0.3571	0.3569

Note. The second CFA model accounts for residual covariance.

## THE CHANGING ASPECTS OF CROATIAN COMPANIES' EFFICIENCY BEFORE AND AFTER COVID-19

**Danijel Petrovic**

*University of Rijeka, Faculty of Tourism and Hospitality Management*

*Naselje Ika, Primorska 46*

*HR – 51410 Opatija*

*dpetrovic@unipu.hr*

### **ABSTRACT**

*This article examines on the changing aspects of efficiency among publicly listed Croatian companies before, during, and after the COVID-19 pandemic. The Zagreb Stock Exchange (ZSE) which serves as the Croatian capital market, lists the largest Croatian companies. This study selects the 18 best-performing Croatian companies base on liquidity and stability on the ZSE. We analyze the components of the CROBEX index from 2018 to 2022 to assess the efficiency of Croatian companies the different phases of the COVID-19 pandemic, employing Data Envelopment Analysis (DEA) methodology. As anticipated, the COVID-19 pandemic in 2020 resulted in a general decline in efficiency. Our results indicate that the tourism, transport and construction sectors experienced the most significant efficiency losses during the pandemic. However, we also found that these companies quickly regained some efficiency in the subsequent years. Conversely, companies in sectors such as food production and ICT were the least affected by the pandemic. Our findings are valuable not only to academics but also to managers, investors, and regulators interested in understanding the dynamics of efficiency before, during, and after the COVID-19 pandemic.*

**Keywords:** *efficiency, COVID-19, DEA, Croatian stock market*

### **1. INTRODUCTION**

The Croatian capital market is still developing, with a centralized focus on the Zagreb Stock Exchange (ZSE). The ZSE is often characterized as small, shallow, and illiquid (see Petrovic & Karanovic, 2023; Učkar & Petrović, 2020; Gardijan & Škrinjarić, 2015). In recent years the number of listings has fallen below 100 (Zagreb Stock Exchange, 2024), further limiting domestic investment opportunities for both institutional and retail investors. These characteristics necessitate a careful examination of available investment options by assessing each company's performance through fundamental analysis. Fundamental analysis employs a combination of accounting, financial, and market data, utilizing simple financial ratios to evaluate a company's performance. Based on the results of this analysis, institutional and retail investors can make informed investment decisions such as shortlisting, buying, selling or holding. Furthermore, by comparing the fundamentals of several companies, investors can distinguish between sound and poor investments. However, fundamental analysis has its limitations, which depend on the accuracy and validity of financial reporting, as well as the subjectivity involved in interpreting the results derived from financial ratios. Financial theory provides reference values for each financial indicator and the signals they convey to decision-makers. However, these reference values can vary based on industry-specific characteristics. depending on the industry idiosyncrasies. Therefore, a further analysis of the firm's key competitors is essential. It is not uncommon for fundamental analysis to yield inconclusive results, thereby introducing subjectivity into the investor's decision-making. Consequently, in addition to assessing a firm's fundamentals, we propose the use of Data Envelopment Analysis (DEA) to evaluate their efficiency, which facilitates easier comparison and ranking, ultimately aiding investors in their decision-making. The primary objective goal of this study is to analyze the changing aspects of efficiency before, during, and after the COVID-19 pandemic for

companies listed on the Croatian stock market (ZSE) in order to identify the best investment options. This paper employs DEA methodology to examine the changing aspects of efficiency of Croatian companies in the period from 2018 to 2022. The observed period captures two years prior to the COVID-19 pandemic, which introduced a structural break in the timeline, with 2022 representing the post-pandemic era. The results indicate that the COVID-19 pandemic had a detrimental effect on efficiency, particularly in the tourism, transport and construction sectors (Škare et al., 2021). In contrast, companies in the food production, trade, and ICT sectors demonstrated higher efficiency and a quicker recovery.

The remainder of this paper is structured as follows: Section 2 provides a brief theoretical and literature review on evaluating companies' performance and efficiency. Section 3 outlines the DEA methodology employed in this study. Section 4 describes the dataset of Croatian companies observed in this study and reports on the fundamental characteristics. Section 5 presents the DEA efficiency results and discusses the empirical findings. Finally, Section 6 concludes with recommendations for future research.

## **2. THEORETICAL AND LITERATURE REVIEW**

We live in a world of finite resources; therefore, economists have developed theories regarding the performance and efficiency of firms. The theoretical framework for efficiency is outlined by microeconomic theories such as production theory, the theory of the firm, and modern portfolio theory. These theories provide insights into how to optimize production to enhance higher shareholder value. Efficiency is a concern not only for economists, but also for investors, managers, and other stakeholders. As Drucker (1963, p 53) stated, the primary duty and ongoing responsibility of a business manager is *to strive for the best possible economic results from the resources currently available*. It is evident that studies on productivity and efficiency are abundant, and the field continues to evolve, recently incorporating machine learning and artificial intelligence techniques into its models.

### **2.1. Theoretical framework**

Microeconomic theory focuses on how individual companies allocate and utilize their available resources. The allocation of resources, aimed at minimizing inputs, is addressed by production theory, which emphasizes output maximization. Additionally, the theory of the firm, as articulated by Coase (1937), explores why successful companies operate efficiently, highlighting the roles of management motivation and decision-making. According to this theory, managers strive to maximize shareholder value by minimizing costs and maximizing profits. It is important to note that the concepts discussed are still evolving. Further insights into the theory of the firm can be found in the works of Demsetz (1988), Jensen & Meckling (1976), and Cyert & Hedrick (1972). Moreover, modern portfolio theory (MPT), proposed by Markowitz (1952a), revolutionized investing by equipping investors with tools to assess stocks and portfolios in terms of their returns and associated risks. The foundational works of Markowitz (1952a, 1952b) established finance as a distinct field of study and laid the groundwork for behavioral finance. Notably, MPT employs linear programming to optimize the relationship between the return and the risk (measured by standard deviation) of a stock. The ability to identify optimal portfolios—those that lie on the efficiency frontier, offering higher returns for equal, or lower risk compared to other portfolios—marked a significant advancement in investment strategy. Despite its limitations, MPT, along with the Capital Asset Pricing Model (Sharpe, 1964), remains widely utilized and continues to be refined although the application of modern statistical and econometric methodologies.



## 2.2. Previous studies

Research on efficiency is abundant. Učkar & Petrović (2021b) provide a comprehensive overview of the theories and methods used for efficiency estimation. Consistent with the findings provided of Berger & Humphrey (1997), they conclude that both parametric (Stochastic Frontier Approach – SFA) and non-parametric (Data Envelopment Analysis – DEA) methods are equally prevalent in empirical studies on efficiency. Emrouznejad & Yang (2018) highlight the widespread use of DEA methodology empirical research, reporting that over 1,000 studies utilizing DEA are published yearly annually. Furthermore, DEA is predominantly applied in the banking sector, second only to agriculture. In the Croatian market, several efficiency studies have been conducted, primarily focusing on the financial sector. One of the earliest studies employing a non-parametric DEA approach was conducted by Jemric & Vujcic (2002) which was followed by research from Jurčević et al. (2013), which examined the efficiency of both banks and insurance companies. More recent studies have specifically analyzed the efficiency of Croatian banks (Učkar & Petrović, 2021a) and insurance companies (Učkar & Petrović, 2022). The findings from these empirical studies in the financial sector converge on the conclusion that larger institutions tend to be more efficient. Efficiency analysis is not limited to the financial sector; numerous studies have applied DEA methodology to assess the efficiency of the public sector and healthcare industry. Including works by Šegota et al. (2017), Rabar & Grbin (2019), and Rabar & Grbin (2021). This study focuses on the Croatian capital market, where Škrinjarić and colleagues have made significant contributions. Gardijan & Kojić (2012) examined the application of a DEA-based investment strategy in the Croatian stock market, followed by Škrinjarić (2014). Both studies utilized market data on stock returns to evaluate the effectiveness of an investment strategy based on DEA methodology. Additionally, the empirical study by Gardijan & Škrinjarić (2015) was the first to incorporate financial data alongside market data in DEA models applied to the Croatian stock market. They focused on six key fundamentals: liquidity, profitability, debt, activity (operating performance), investment, and efficiency, as defined by specific financial ratios. Their results indicate that DEA portfolios generally outperform the market return during the observed period. The authors affirm that efficiency scores can serve as a valuable approach to portfolio weighting (Gardijan & Škrinjarić, 2015, p 414). Furthermore, they conclude that incorporating financial ratios into portfolio selection positively impacts the construction of superior portfolios compared to the market.

## 3. METHODOLOGY

DEA methodology is a linear programming model first introduced by Charnes et al. (1978) to measure efficiency. Their static model assumes constant returns to scale (CRS). The resulting information indices global technical efficiency and is widely known as the CCR model. Shortly thereafter, Banker et al. (1984) expanded the CCR model to allow for variable returns to scale (VRS). The results from the BCC model, as it is also known, insights into pure technical efficiency. DEA methodology defines efficiency as the ratio of weighted outputs to weighted inputs for each decision-making unit (DMU). Efficiency of each DMU is represented as a fractional programming model (1-4).

$$\max_{u,v} \theta(u,v) = \frac{u_1 y_{1j} + u_2 y_{2j} + \dots + u_s y_{sj}}{v_1 x_{1j} + v_2 x_{2j} + \dots + v_m x_{mj}} = \frac{\sum_{r=1}^s u_r y_{rj}}{\sum_{i=1}^m v_i x_{ij}} \quad (1)$$

$$\text{subject to} \quad \frac{u_1 y_{1j} + \dots + u_s y_{sj}}{v_1 x_{1j} + \dots + v_m x_{mj}} = \frac{\sum_{r=1}^s u_r y_{rj}}{\sum_{i=1}^m v_i x_{ij}} \leq 1, \text{ where } j = 1, \dots, n \quad (2)$$

$$u_r \geq 0, r = 1, \dots, s \quad (3)$$

$$v_i \geq 0, i = 1, \dots, m \quad (4)$$

Where  $y_{rj}$  denotes every output  $r = 1, \dots, s$  and  $j = 1, \dots, n$ . Similarly,  $x_{ij}$  represents each input  $i = 1, \dots, m$  and  $j = 1, \dots, n$ . In this model, it is necessary to obtain values for the input weights

( $v_i$ ) where  $i = 1, \dots, m$  and the output weights ( $u_r$ ) where  $r = 1, \dots, s$ . However, the fractional programming model from (1-4) has an infinite number of solutions. If some ( $u^*, v^*$ ) is optimal, then for each positive scalar  $c$ , ( $cu^*, cv^*$ ) is also optimal. To obtain a representative solution ( $u, v$ ) it is necessary to define the weighted sum of input variables ( $v_i x_{i0}$ ) equal to 1, as shown in equation (5).

$$\sum_{i=1}^m v_i x_{i0} = 1 \tag{5}$$

The transformation from (5) simplifies the fractional programming problem (1-4) into a linear programming problem for each DMU. The CCR model now is (6-10).

$$\max_{u,v} z_0 = \mu_1 y_{10} + \dots + \mu_s y_{s0} = \sum_{r=1}^s \mu_r y_{r0} \tag{6}$$

subject to 
$$\sum_{r=1}^s \mu_r y_{rj} - \sum_{i=1}^m v_i x_{ij} \leq 0, j = 1, \dots, n \tag{7}$$

$$\sum_{i=1}^m v_i x_{i0} = 1 \tag{8}$$

$$\mu_r \geq 0, r = 1, \dots, s \tag{9}$$

$$v_i \geq 0, i = 1, \dots, m \tag{10}$$

The dual of the linear problem (6-10) for each DMU (bank) is of the form (11-14):

$$\min_{\lambda} z_0 = \Theta_0 \tag{11}$$

subject to 
$$\sum_{j=1}^n \lambda_j y_{rj} \geq y_{r0}, r = 1, \dots, s \tag{12}$$

$$\Theta_0 x_{i0} - \sum_{j=1}^n \lambda_j x_{ij} \geq 0, i = 1, \dots, m \tag{13}$$

$$\lambda_j \geq 0, j = 1, \dots, n \tag{14}$$

The efficiency score for the  $i$ -th DMU is represented by the scalar  $\theta_0$  and  $\lambda_j$  is a  $N \times 1$  vector of constraints. As previously mentioned, Banker et al. (1984) developed the BCC mode, which allows for variable returns to scale (VRS) by introducing a convexity condition for  $\lambda_j$  in the equations (11-14). This convexity condition requires that the sum of the components of the vector  $\lambda_j$  is equal to one. The input-oriented BCC model is detailed in equations (15-19).

$$\min_{\lambda} z_0 = \Theta_0 \tag{15}$$

subject to 
$$\sum_{j=1}^n \lambda_j y_{rj} \geq y_{r0}, r = 1, \dots, s \tag{16}$$

$$\Theta_0 x_{i0} - \sum_{j=1}^n \lambda_j x_{ij} \geq 0, i = 1, \dots, m \tag{17}$$

$$\sum_{j=1}^n \lambda_j = 1 \tag{18}$$

$$\lambda_j \geq 0, j = 1, \dots, n \tag{19}$$

In contrast to the CCR model, the BCC model allows for variable returns to scale (VRS) and provides information on pure technical efficiency. Since both the CCR and BCC models are

static, this paper follows the empirical study conducted by Gardijan & Škrinjarić (2015) and employs Window Analysis by dividing the entire analysis period into  $k$  moving average time windows of length  $p$ . This approach involves calculating the efficiency scores for  $k$ - $p$  DMUs for each window. The advantage of this method is that it allows for the analysis of each DMU, enabling comparisons not only with other DMUs (benchmarking), but also with its own performance across different periods (Gardijan & Škrinjarić, 2015, p. 410). This facilitates the examination of the evolving aspects of efficiency before, during and after the COVID-19 pandemic. However, this analysis assumes that the technology did not change during the observed period, which could positively influence the efficiency frontier. Given that the observed period is relatively short (2018-2022), it is concluded that there have not been any technological changes that would significantly impact efficiency.

#### 4. DATA AND ANALYSIS

The sample in this study is composed by selecting the most liquid companies listed on the Croatian Stock Exchange. As previously mentioned, the Croatian stock market is small, shallow, and illiquid, as noted by Gardijan & Škrinjarić (2015), Učkar & Petrović (2020), and Petrović & Karanović (2023). To address this limitation, we focus on the most liquid within the CROBEX index on the ZSE, with the composition detailed in Table 1.

Symbol	Issuer	Number of Shares	Free Float Factor	Rep. Factor	Last Price (€)	Free Float Market Cap.(€)	Weight
ADPL	AD PLASTIK d.d.	4.199.584	0,70	1.00000000	12,30	36.158.418,24	1,11 %
ADRS2	ADRIS GRUPA d.d.	6.784.100	0,95	0,76095566	59,20	290.333.336,24	8,90 %
ARNT	Arena Hospitality Group d.d.	5.128.721	0,50	1.00000000	32,60	83.598.152,30	2,56 %
ATGR	ATLANTIC GRUPA d.d.	13.337.200	0,45	0,90925720	51,50	281.041.953,34	8,62 %
ATPL	ATLANTSKA PLOVIDBA d.d.	2.093.270	0,30	1.00000000	48,00	30.143.088,00	0,92 %
CKML	Čakovečki mlinovi d.d.	10.290.000	0,80	1.00000000	10,70	88.082.400,00	2,70 %
DLKV	Dalekovod d.d.	41.247.193	0,25	1.00000000	3,16	32.585.282,47	1,00 %
ERNT	ERICSSON NIKOLA TESLA d.d.	1.331.650	0,55	1.00000000	187,00	136.960.202,50	4,20 %
HPB	HPB d.d.	2.024.625	0,30	1.00000000	232,00	140.913.900,00	4,32 %
HT	HT d.d.	78.000.000	0,40	0,34604074	31,80	343.327.780,60	10,53 %
INGR	INGRA d.d.	13.545.200	0,95	1.00000000	2,38	30.625.697,20	0,94 %
KODT	KONCAR - DISTRIBUTIVNI I SPECIJALNI TRANSFORMATORI d.d.	388.376	0,30	1.00000000	1.710,00	199.236.888,00	6,11 %
KOEI	KONCAR d.d.	2.572.119	1,00	0,47435169	370,00	451.432.927,98	13,84 %
MAIS	MAISTRA d.d.	10.944.339	0,11	1.00000000	42,60	51.285.172,55	1,57 %
PLAG	PLAVA LAGUNA d.d.	2.197.772	0,16	1.00000000	342,00	120.262.083,84	3,69 %
PODR	PODRAVKA d.d.	7.120.003	0,80	0,32933393	159,00	298.266.010,05	9,15 %
RIVP	Valamar Riviera d.d.	126.027.542	0,55	0,91545567	5,16	327.427.517,98	10,04 %
SPAN	SPAN d.d.	1.960.000	0,55	1.00000000	49,80	53.684.400,00	1,65 %
ULPL	ALPHA ADRIATIC d.d.	580.000	0,85	1.00000000	16,00	7.888.000,00	0,24 %
VLEN	BRODOGRADILISTE VIKTOR LENAC d.d.	16.813.247	0,14	1.00000000	4,70	11.063.116,53	0,34 %
ZABA	Zagrebacka banka d.d.	320.241.955	0,04	1.00000000	19,25	246.586.305,35	7,56 %

Table 1: Components of the CROBEX index (ZSE)

(Source: Author's representation based on the ZSE data, available at:

[https://zse.hr/en/indeks-366/365?isin=HRZB00ICBEX6&tab=stock\\_info](https://zse.hr/en/indeks-366/365?isin=HRZB00ICBEX6&tab=stock_info) (accessed 5.9.2024))

CROBEX index is composed of 21 stocks (see Table 1) which serves as the basis for our sample. To evaluate the changing aspects of efficiency of an individual stocks during the observed period, a longitudinal sample is extracted from the CROBEX index. Consequently, stocks that have been listed on the ZSE after 2018 are excluded from the sample (SPAN). Additionally, financial institutions (HPB and ZABA) are also excluded due to the specific nature of their financial statements (balance sheets), which impedes comparability with other companies. Thus, the longitudinal sample consists of 18 stocks for the period from 2018 to 2022. As noted by Gardijan & Škrinjarić (2015, p. 410), the Window Analysis implemented in this paper increases the number of units available for evaluation, thereby enhancing the discriminatory power of the method. Učkar & Petrović (2021b) summarize that the DEA methodology performs well with smaller samples. Cook et al. (2014) provide recommendations for selecting a model, suggesting that the number of DMUs should be at least twice the combined number of inputs and outputs. This implies that the maximum number of input and output variables is limited to nine in this study. However, the Window Analysis increases the number of observations to 90, calculated as 5 years multiplied by 18 DMUs (companies) observed in this study. Following Gardijan & Škrinjarić (2015), we employ various financial indicators as input and output variables in the DEA models, classifying financial indicators that are preferred to be lower as inputs, and those that financial indicators whose are preferred to be higher as outputs, such as:

- Input 1 ( $x_{1j}$ ): Debt ratio =  $\frac{\text{total liabilities}}{\text{total assets}}$
- Input 2 ( $x_{2j}$ ): Debt to equity ratio =  $\frac{\text{total liabilities}}{\text{shareholder's equity}}$
- Output 1 ( $y_{1j}$ ): Current liquidity ratio =  $\frac{\text{short-term assets}}{\text{short-term liabilities}}$
- Output 2 ( $y_{2j}$ ): Total Asset Turnover =  $\frac{\text{total revenue}}{\text{total assets}}$
- Output 3 ( $y_{3j}$ ): Return on Assets (ROA) =  $\frac{\text{net income}}{\text{total assets}}$
- Output 4 ( $y_{4j}$ ): Return on Equity (ROE) =  $\frac{\text{net income}}{\text{equity}}$
- Output 5 ( $y_{5j}$ ): Total Share Rentability =  $\frac{\text{earnings per stock}}{\text{average stock price}}$

A correlation matrix of variables is presented in Table 2.

Variable	Debt Ratio	Debt to Equity Ratio	Current Liquidity Ratio	Total Asset Turnover	ROA	ROE	Total Share Rentability
Debt Ratio	1	-0.3161	-0.2468	-0.0332	-0.1996	-0.1371	0.0190
Debt to Equity Ratio	-0.3161	1	0.0640	0.2837	-0.0490	0.0616	-0.0651
Current Liquidity Ratio	-0.2468	0.0640	1	0.3097	0.0824	0.0284	-0.0004
Total Asset Turnover	-0.0332	0.2837	0.3097	1	0.2628	0.1764	0.0709
ROA	-0.1996	-0.0490	0.0824	0.2628	1	0.3861	0.7646
ROE	-0.1371	0.0616	0.0284	0.1764	0.3861	1	0.2112
Total Share Rentability	0.0190	-0.0651	-0.0004	0.0709	0.7646	0.2112	1

Table 2: Components of variables used in efficiency estimation  
(Source: Author's calculation based on companies' financial statements)

We can observe that the correlations presented in Table 2 align with the previously mentioned microeconomic theories. The debt ratio is negatively correlated with all other variables, including the debt-to-equity ratio. In contrast, the other variables exhibit positive correlations, with stronger relationships observed between profitability, efficiency, and investment indicators. The primary objective of this paper is to analyze the changing aspects of efficiency among selected Croatian companies during the period from 2018 to 2022. To achieve this, the CCR (Charnes et al., 1978) and BCC (Banker et al., 1984) DEA models have been calculated using Window Analysis, as outlined by Gardijan & Škrinjarić (2015). The results are presented and discussed in the following section.

## 5. RESULTS AND DISCUSSION

The efficiency results for the input-oriented CCR (CRS) model are presented in Table 3.

Symbol	2018	2019	2020	2021	2022	Average	SD
ADPL	35.72%	36.95%	29.55%	27.19%	21.27%	30.14%	5.75%
ADRS2	63.99%	99.56%	11.12%	58.58%	86.22%	63.89%	30.28%
ARNT	44.22%	62.67%	4.40%	11.59%	13.10%	27.20%	22.41%
ATGR	66.43%	98.01%	92.50%	100.00%	66.02%	84.59%	15.20%
ATPL	6.54%	7.04%	5.02%	100.00%	16.13%	26.95%	36.73%
CKML	100.00%	82.86%	74.78%	83.57%	100.00%	88.24%	10.09%
DLKV	18.71%	21.81%	23.57%	24.38%	32.11%	24.12%	4.44%
ERNT	66.33%	55.95%	56.31%	72.25%	55.87%	61.34%	6.75%
HT	93.81%	62.89%	65.87%	77.63%	77.48%	75.54%	10.91%
INGR	82.97%	95.44%	93.04%	37.55%	43.52%	70.50%	24.90%
KODT	41.04%	36.80%	56.22%	55.80%	65.47%	51.07%	10.59%
KOEI	38.84%	31.61%	35.09%	43.50%	44.99%	38.81%	5.02%
MAIS	40.05%	26.71%	5.66%	26.32%	38.27%	27.40%	12.27%
PLAG	76.53%	46.82%	6.87%	37.81%	86.12%	50.83%	28.37%
PODR	42.58%	48.55%	57.30%	82.07%	73.13%	60.73%	14.82%
RIVP	20.71%	22.51%	2.54%	9.56%	16.49%	14.36%	7.40%
ULPL	41.87%	24.91%	100.00%	100.00%	100.00%	73.36%	33.07%
VLEN	27.11%	41.47%	84.82%	58.98%	65.01%	55.48%	19.82%

Table 3: Input-oriented CCR (CRS) Window analysis 2018-2022 efficiency results  
(Source: Author's calculation based on companies' financial statements)

The input-oriented CCR model (Charnes et al., 1978) assumes constant returns to scale (CRS), with the objective of minimizing inputs, specifically debt indicators in our case. In this model, the highest average efficiency is achieved by CKML, followed by ATGR and HT, both of which exceed 75% efficiency. As anticipated, a significant decline in efficiency was observed in 2020 due to the COVID-19 pandemic. The two best-performing companies are in the food production sector, while the third operates in ICT – industries that experienced a relatively mild and brief impact from the pandemic. Conversely, tourism, a major contributor to the Croatian economy, was severely affected by the pandemic, travel bans, and lockdowns. For a comprehensive analysis of the impact of COVID-19 on the travel and tourism industry, refer to Škare et al. (2021). Companies in this sector (ARNT, MAIS, PLAG, RIVP) reported the lowest efficiency levels in 2020. In the subsequent years, the recovery was slow. Despite improvements in efficiency, levels remain below those recorded prior to the pandemic. The output-oriented BCC model (Banker et al., 1984) emphasizes output maximization, specifically aiming to enhance companies' fundamentals in terms of liquidity, efficiency, profitability, and investment indicators. The results of this model are presented in Table 4.

Symbol	2018	2019	2020	2021	2022	Average	SD
ADPL	35.72%	36.95%	29.55%	27.19%	25.62%	31.01%	4.54%
ADRS2	63.99%	99.56%	11.12%	58.58%	86.22%	63.89%	30.28%
ARNT	44.22%	62.67%	31.47%	11.59%	13.10%	32.61%	19.30%
ATGR	66.43%	98.01%	92.50%	100.00%	66.02%	84.59%	15.20%
ATPL	6.54%	7.04%	11.79%	100.00%	16.13%	28.30%	36.02%
CKML	100.00%	82.86%	74.78%	83.57%	100.00%	88.24%	10.09%
DLKV	23.98%	21.81%	23.57%	24.38%	32.11%	25.17%	3.58%
ERNT	66.33%	55.95%	56.31%	72.25%	55.87%	61.34%	6.75%
HT	93.81%	62.89%	65.87%	77.63%	77.48%	75.54%	10.91%
INGR	17.55%	29.26%	32.58%	25.03%	19.59%	24.80%	5.66%
KODT	41.04%	36.80%	56.22%	55.80%	65.47%	51.07%	10.59%
KOEI	38.84%	31.61%	35.09%	43.50%	44.99%	38.81%	5.02%
MAIS	40.05%	26.71%	13.65%	26.32%	38.27%	29.00%	9.55%
PLAG	76.53%	46.82%	17.60%	37.81%	86.12%	52.97%	25.19%
PODR	42.58%	48.55%	57.30%	82.07%	73.13%	60.73%	14.82%
RIVP	20.71%	22.51%	13.08%	9.56%	16.49%	16.47%	4.77%
ULPL	33.32%	30.77%	100.00%	100.00%	100.00%	72.82%	33.30%
VLEN	29.15%	41.47%	84.82%	58.98%	65.01%	55.89%	19.25%

Table 4: Output oriented CCR (CRS) Window analysis 2018-2022 efficiency results  
(Source: Author's calculation based on companies' financial statements)

The results are quite comparable to those of the input-oriented model. Three companies-CKML, ATGR, and HT-are the most efficient during the observed period. One notable difference is that tourism companies, despite experiencing the greatest challenges in 2020 due to the pandemic, report higher efficiency levels than those indicated by the input-oriented model.

Symbol	2018	2019	2020	2021	2022	Average	SD
ADPL	41.44%	43.62%	42.32%	41.39%	38.68%	41.49%	1.62%
ADRS2	70.16%	100.00%	33.94%	66.15%	86.33%	71.32%	22.24%
ARNT	61.41%	72.35%	31.12%	34.10%	33.89%	46.57%	16.97%
ATGR	69.12%	100.00%	92.70%	100.00%	70.77%	86.52%	13.80%
ATPL	26.01%	26.00%	23.84%	100.00%	38.08%	42.78%	29.04%
CKML	100.00%	85.85%	79.88%	86.11%	100.00%	90.37%	8.17%
DLKV	23.08%	25.03%	26.14%	31.93%	41.50%	29.54%	6.67%
ERNT	100.00%	74.81%	100.00%	100.00%	65.73%	88.11%	14.85%
HT	100.00%	79.87%	91.11%	100.00%	96.91%	93.58%	7.59%
INGR	84.05%	95.67%	93.46%	39.35%	44.25%	71.36%	24.49%
KODT	42.17%	41.54%	58.04%	57.38%	65.50%	52.93%	9.48%
KOEI	56.40%	50.60%	51.51%	55.43%	54.12%	53.61%	2.23%
MAIS	45.99%	38.83%	33.80%	38.69%	47.54%	40.97%	5.09%
PLAG	82.44%	58.76%	49.37%	56.74%	88.50%	67.16%	15.39%
PODR	53.71%	57.86%	65.50%	85.10%	76.22%	67.68%	11.60%
RIVP	32.05%	34.26%	26.48%	29.76%	32.83%	31.08%	2.72%
ULPL	46.99%	28.89%	100.00%	100.00%	100.00%	75.18%	30.94%
VLEN	45.41%	52.95%	91.48%	74.34%	68.10%	66.46%	16.22%

Table 5: Input oriented BCC (VRS) Window analysis 2018-2022 efficiency results  
(Source: Author's calculation based on companies' financial statements)

To account for variable returns to scale (VRS), the BCC model (Banker et al., 1984) is utilized. Efficiency results for the input-oriented BCC model are presented in Table 5. The BCC models consistently yield higher efficiency levels. In this model, the highest efficiency is achieved by HT (98.58%), followed by CKML (90.37%), ERNT (88.11%), and ATGR (86.52%). Overall, efficiency scores are elevated across the board, although the impact of the COVID-19 pandemic in 2020 on efficiency remains evident. As observed in previous analyses, companies operating in the tourism sector (ARNT, MAIS, PLAG, RIVP) exhibit lower efficiency scores. However, efficiency rebounded quickly and surpassed previous levels in the subsequent years. For the output-oriented BCC (VRS) model, efficiency results are presented in Table 6.

Symbol	2018	2019	2020	2021	2022	Average	SD
ADPL	47.81%	49.70%	41.68%	40.33%	32.80%	42.46%	5.99%
ADRS2	65.49%	100.00%	14.98%	60.77%	88.47%	65.94%	29.30%
ARNT	45.27%	63.58%	32.75%	14.47%	17.28%	34.67%	18.23%
ATGR	81.22%	100.00%	93.50%	100.00%	77.45%	90.43%	9.45%
ATPL	13.21%	14.24%	14.43%	100.00%	19.95%	32.37%	33.90%
CKML	100.00%	91.37%	83.80%	92.51%	100.00%	93.54%	6.07%
DLKV	57.28%	66.02%	68.85%	51.69%	55.66%	59.90%	6.48%
ERNT	100.00%	94.79%	100.00%	100.00%	92.41%	97.44%	3.22%
HT	100.00%	65.72%	78.24%	100.00%	93.84%	87.56%	13.51%
INGR	48.14%	41.78%	64.54%	54.09%	58.28%	53.37%	7.89%
KODT	65.74%	66.35%	72.70%	77.01%	82.17%	72.79%	6.28%
KOEI	40.59%	39.27%	39.65%	47.91%	53.83%	44.25%	5.74%
MAIS	43.11%	29.53%	15.10%	29.01%	38.59%	31.07%	9.62%
PLAG	78.42%	47.53%	17.73%	38.46%	87.59%	53.95%	25.78%
PODR	49.01%	52.54%	57.48%	83.62%	73.79%	63.29%	13.25%
RIVP	25.80%	27.30%	15.15%	13.31%	21.76%	20.66%	5.59%
ULPL	34.62%	36.29%	100.00%	100.00%	100.00%	74.18%	31.62%
VLEN	37.19%	44.90%	88.51%	61.19%	72.24%	60.80%	18.49%

Table 6: Output oriented BCC (VRS) Window analysis 2018-2022 efficiency results  
(Source: Author's calculation based on companies' financial statements)

From Table 6, we can observe that efficiency levels are higher. The most efficient company during the observed period is ERNT (97.44%), followed by CKML (93.54%), and ATGR (90.43%), and HT (87.56%). The output-oriented BCC models yield the highest efficiency scores. Nonetheless, the impact of the COVID-19 pandemic remains evident, particularly in the tourism sector (Škare et al., 2021). Companies such as ARNT, MAIS, PLAG, and RIVP experienced a sharp decline in efficiency in 2020. While PLAG quickly recovered in the subsequent years, ARNT, MAIS, and RIVP did not return to their pre-pandemic efficiency levels.

It is important to note that companies in the transportation and construction industries were also significantly impacted by the pandemic. The two worst-performing companies in this sample, regardless of the model and orientation, are ATPL (transportation) and DLKV (construction). The results of this longitudinal study indicate that the COVID-19 pandemic negatively affected the efficiency of Croatian companies comprising the CROBEX index. Although efficiency scores recovered in the following years, recovery has been slow in some cases. Findings from this analysis reveal that companies in the food production, trade and ICT sectors were less affected by the pandemic and recovered their efficiency more quickly, while companies in

transportation, tourism, and construction were generally less efficient. The distinction between this study and the previously mentioned studies by Škrinjarić, Gardijan and colleagues, which that focused on portfolio selection, is evident in the longitudinal approach that highlights the changing aspects of efficiency among 18 Croatian companies during periods before, during and after the pandemic. This study is also unique in compared to previous research that focused exclusively on the efficiency of the Croatian financial market (Jemric & Vujcic, 2002; Učkar & Petrović, 2021a, 2022).

## 6. CONCLUSION

It is widely acknowledged that the COVID-19 pandemic significantly impacted the efficiency of Croatian companies. Numerous studies assess efficiency using financial or market data, or a combination of both, employing DEA methodology to evaluate the efficiency of individual companies and stock portfolios. Although there is a low probability that the financial data published in the financial reports of listed companies contain errors or are artificially inflated through creative accounting practices, these reports still serve as a credible source of information regarding a firm's performance. In contrast, market data, which can be easily manipulated in smaller countries, may present a distorted view of a business's financial performance and health. Flaws in an investor's decision-making processes can further obscure the true value of assets on the market. This paper utilizes DEA methodology, focusing on selected financial indicators to analyze the changing aspects of efficiency during the recent pandemic. The findings indicate that the COVID-19 pandemic has affected efficiency scores across various sectors. As anticipated, the tourism, transportation, and construction industries were the most severely impacted and have shown a slow recovery. Conversely, companies in food production, trade, and ICT achieved the highest efficiency scores and recovered rapidly after the pandemic. These findings offer valuable insights into the changing aspects of efficiency among Croatian companies before, during, and after the COVID-19 pandemic. However,, this study has several limitations, including its exclusive focus on a single stock market which limits the number of companies observed, particularly given the small, shallow and illiquid nature of the Croatian stock market. Additionally, the study concentrates solely on financial indicators as inputs and outputs in the efficiency models. Nevertheless, the insights gained from this research could be beneficial for future studies on efficiency dynamics. Incorporating additional financial and market data, along with various econometric models on an international scale, could facilitate a deeper understanding of the changing aspects of efficiency. Further research is needed to explore the differences in efficiency across industries and their dynamics. These findings may prove useful to investors, managers, and regulators interested in enhancing companies' efficiency.

**ACKNOWLEDGEMENT:** *This paper is a result of scientific project “The Impact of Artificial Intelligence and New Digital Technologies on the Financial Market” supported by the Faculty of Economics and Tourism „Dr. Mijo Mirković“, Juraj Dobrila University of Pula. Any opinions, findings, and conclusions or recommendations expressed in this paper are those of the authors and do not necessarily reflect the views of the Faculty of Economics and Tourism „Dr. Mijo Mirković“ Pula.*

## LITERATURE:

1. Banker, R. D., Charnes, A., & Cooper, W. W. (1984). Some Models for Estimating Technical and Scale Inefficiencies in Data Envelopment Analysis. *Management Science*, 30(9), 1078–1092.  
[https://econpapers.repec.org/article/inmormnsc/v\\_3a30\\_3ay\\_3a1984\\_3ai\\_3a9\\_3ap\\_3a1078-1092.htm](https://econpapers.repec.org/article/inmormnsc/v_3a30_3ay_3a1984_3ai_3a9_3ap_3a1078-1092.htm)



2. Berger, A. N., & Humphrey, D. B. (1997). Efficiency of financial institutions: International survey and directions for future research. *European Journal of Operational Research*, 98(2), 175–212. [https://doi.org/10.1016/S0377-2217\(96\)00342-6](https://doi.org/10.1016/S0377-2217(96)00342-6)
3. Charnes, A., Cooper, W. W., & Rhodes, E. (1978). Measuring the efficiency of decision making units. *European Journal of Operational Research*, 2(6), 429–444. [https://doi.org/10.1016/0377-2217\(78\)90138-8](https://doi.org/10.1016/0377-2217(78)90138-8)
4. Coase, R. H. (1937). The Nature of the Firm. *Economica*, 4(16), 386–405. <https://doi.org/10.1111/j.1468-0335.1937.tb00002.x>
5. Cook, W. D., Tone, K., & Zhu, J. (2014). Data envelopment analysis: Prior to choosing a model. *Omega*, 44, 1–4. <https://doi.org/10.1016/J.OMEGA.2013.09.004>
6. Cyert, R., & Hedrick, C. (1972). Theory of the Firm: Past, Present, and Future; An Interpretation. *Journal of Economic Literature*, 10, 398–412. [jensenhttps://www.jstor.org/stable/2721463?origin=JSTOR-pdf](https://www.jstor.org/stable/2721463?origin=JSTOR-pdf)
7. Demsetz, H. (1988). The Theory of the Firm Revisited. *Journal of Law, Economics, & Organization*, 4(1), 141–161. <https://www.jstor.org/stable/765018>
8. Drucker, P. F. (1963). Managing for Business Effectiveness. *Harvard Business Review*, 53–60. [https://rlaexp.com/studio/biz/conceptual\\_resources/authors/peter\\_drucker/managing-for-business-effectiveness.pdf](https://rlaexp.com/studio/biz/conceptual_resources/authors/peter_drucker/managing-for-business-effectiveness.pdf)
9. Emrouznejad, A., & Yang, G. liang. (2018). A survey and analysis of the first 40 years of scholarly literature in DEA: 1978–2016. *Socio-Economic Planning Sciences*, 61, 4–8. <https://doi.org/10.1016/J.SEPS.2017.01.008>
10. Gardijan, M., & Kojić, V. (2012). DEA-Based Investment Strategy and its Application in the Croatian Stock Market . *Croatian Operational Research Review*, 3(1), 203–212.
11. Gardijan, M., & Škrinjarić, T. (2015). Equity portfolio optimization: A DEA based methodology applied to the Zagreb Stock Exchange. *Croatian Operational Research Review*, 6(2), 405–417. <https://doi.org/10.17535/crorr.2015.0031>
12. Jemric, I., & Vujcic, B. (2002). Efficiency of Banks in Croatia: A DEA Approach. *Comparative Economic Studies*, 44(2–3), 169–193. <https://doi.org/10.1057/CES.2002.13>
13. Jensen, M. C., & Meckling, W. H. (1976). Theory of the firm: Managerial behavior, agency costs and ownership structure. *Journal of Financial Economics*, 3(4), 305–360. [https://doi.org/10.1016/0304-405X\(76\)90026-X](https://doi.org/10.1016/0304-405X(76)90026-X)
14. Jurčević, B., Maja, & Žaja, M., Jurcevic', B., Mihelja Zaja B ', M., Candidate, R., Assistant, T., Jurcevic, B., & Zaja, M. M. (2013). Banks and Insurance Companies Efficiency Indicators in the Period of Financial Crisis: The Case of the Republic of Croatia. *Economic Research-Ekonomska Istraživanja*, 26(1), 203–224. <https://doi.org/10.1080/1331677X.2013.11517598>
15. Markowitz, H. (1952a). Portfolio Selection. *The Journal of Finance*, 7(1), 77–91. <https://doi.org/10.2307/2975974>
16. Markowitz, H. (1952b). The Utility of Wealth. *Journal of Political Economy*, 60(2), 151–158. <https://www.jstor.org/stable/1825964>
17. Petrovic, D., & Karanovic, G. (2023). Investors' decision-making under risk: Evidence from the Croatian stock market. *International Journal of Business and Economic Sciences Applied Research (IJBESAR)*, 16(2), 59–70. <https://doi.org/10.25103/IJBESAR.162.07>

18. Rabar, D., & Grbin, A. (2019). Analysis of the Regional Efficiency in Croatia Using Fiscal Indicators – A Nonparametric Approach. *Ekonomski Pregled*, 70(4), 627–649. <https://doi.org/10.32910/EP.70.4.3>
19. Rabar, D., & Grbin, A. (2021). Comparative efficiency analysis of Croatian cities and municipalities: A non-parametric approach from a fiscal perspective. *Interdisciplinary Management Research XVII*, 1, 874–899. <https://www.bib.irb.hr:8443/1114056>
20. Šegota, A., Cerović, L., & Maradin, D. (2017). Efficiency of municipal service providers in the Republic of Croatia. *Croatian Operational Research Review*, 8(2), 537–562. <https://doi.org/10.17535/CORRR.2017.0035>
21. Sharpe, W. F. (1964). Capital Asset Prices: A Theory of Market Equilibrium Under Conditions of Risk. *The Journal of Finance*, 19(3), 425–442. <https://doi.org/10.1111/j.1540-6261.1964.tb02865.x>
22. Škare, M., Soriano, D. R., & Porada-Rochoń, M. (2021). Impact of COVID-19 on the travel and tourism industry. *Technological Forecasting and Social Change*, 163, 120469. <https://doi.org/10.1016/J.TECHFORE.2020.120469>
23. Škrinjarić, T. (2014). Investment Strategy on the Zagreb Stock Exchange Based on Dynamic DEA. *Croatian Economic Survey*, 16(1), 129–160. <https://doi.org/10.15179/CES.16.1.5>
24. Učkar, D., & Petrović, D. (2020). Analysis of Sectoral Index Stock Returns and Risk (Volatility) on The Croatian Financial Market. *The 9th International Scientific Conference “Tourism, Innovations and Entrepreneurship,”* 381–394. [https://fet.unipu.hr/\\_download/repository/Conference\\_Proceedings\\_2020.pdf#page=391](https://fet.unipu.hr/_download/repository/Conference_Proceedings_2020.pdf#page=391)
25. Učkar, D., & Petrović, D. (2021a). Efficiency of banks in Croatia. *Zbornik Radova Ekonomskog Fakulteta u Rijeci*, 39(2). <https://doi.org/10.18045/zbefri.2021.2.349>
26. Učkar, D., & Petrović, D. (2021b). Financial Institutions Efficiency: Theory, Methods and Empirical Evidence. *Economic and Social Development (Book of Proceedings)*, 64th International Scientific Conference on Economic and Social Development, 63. <https://www.bib.irb.hr/1106438>
27. Učkar, D., & Petrović, D. (2022). Efficiency of Insurance Companies in Croatia. *Ekonomska Misao i Praksa*, 31(1), 49–79. <https://doi.org/10.17818/EMIP/2022/1.3>
28. Zagreb Stock Exchange. (2024). Zagreb Stock Exchange Statistics: Listings. <https://zse.hr/en/listings/46>

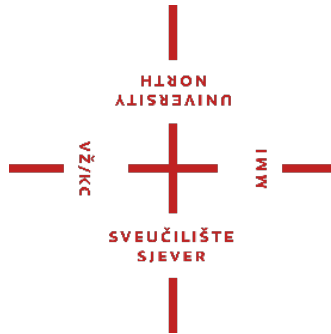

Supported by:  
Centro De Convenções FIRJAN, Brasil

